



UNIL | Université de Lausanne

Unicentre
CH-1015 Lausanne
<http://serval.unil.ch>

2021

Le mobilier céramique des fouilles de Vidy-Boulodrome

Étude diachronique d'une sélection d'ensembles et analyse fonctionnelle
de quelques espaces de la parcelle 2

Volume 2 – Annexes

Maxime Sacchetto

Sacchetto Maxime, Le mobilier céramique des fouilles de Vidy-Boulodrome. Étude diachronique d'une sélection d'ensembles et analyse fonctionnelle de quelques espaces de la parcelle, 2021

Originally published at : Mémoire de maîtrise, Université de Lausanne

Posted at the University of Lausanne Open Archive.
<http://serval.unil.ch>

Droits d'auteur

L'Université de Lausanne attire expressément l'attention des utilisateurs sur le fait que tous les documents publiés dans l'Archive SERVAL sont protégés par le droit d'auteur, conformément à la loi fédérale sur le droit d'auteur et les droits voisins (LDA). A ce titre, il est indispensable d'obtenir le consentement préalable de l'auteur et/ou de l'éditeur avant toute utilisation d'une oeuvre ou d'une partie d'une oeuvre ne relevant pas d'une utilisation à des fins personnelles au sens de la LDA (art. 19, al. 1 lettre a). A défaut, tout contrevenant s'expose aux sanctions prévues par cette loi. Nous déclinons toute responsabilité en la matière.

Copyright

The University of Lausanne expressly draws the attention of users to the fact that all documents published in the SERVAL Archive are protected by copyright in accordance with federal law on copyright and similar rights (LDA). Accordingly it is indispensable to obtain prior consent from the author and/or publisher before any use of a work or part of a work for purposes other than personal use within the meaning of LDA (art. 19, para. 1 letter a). Failure to do so will expose offenders to the sanctions laid down by this law. We accept no liability in this respect.

UNIVERSITÉ DE LAUSANNE
FACULTÉ DES LETTRES

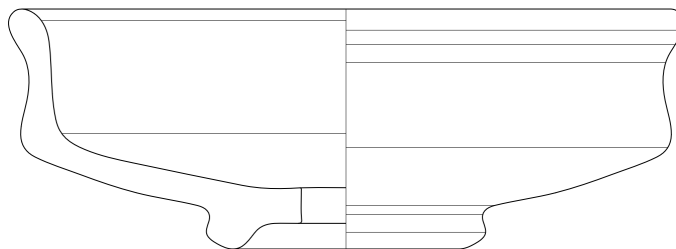
Mémoire de Maîtrise universitaire ès lettres en Sciences de l'Antiquité

Spécialisation Archéologie

Le mobilier céramique des fouilles de Vidy-Boulodrome

Étude diachronique d'une sélection d'ensembles et analyse fonctionnelle
de quelques espaces de la parcelle 2

Volume 2 - Annexes



par

Maxime Sacchetto

sous la direction du Professeur Thierry Luginbühl
et l'expertise de Richard Sylvestre (IASA)

Session de juin 2021

Sommaire

2. Vidy Boulodrome, les autres bâtiments et la parcelle 2

2.1. Les fouilles de Vidy-Boulodrome 11

Fig. 1 : Chronologie relative et chronologie absolue de la parcelle 2
..... 11

Fig. 2.1: Situation du site de Vidy-Boulodrome..... 12

Fig. 2.2: Plan général des vestiges du *vicus* de *Lousonna*, et situation
du site de Vidy-Boulodrome 13

2.2. Description sommaire et évolution des vestiges des quatre parcelles 14

Fig. 3.1: Plan des vestiges vers 100 ap. J.-C. 14

Fig. 3.2: Plan des vestiges vers 150 ap. J.-C. 15

Fig. 3.3: Plan des vestiges vers 180 ap. J.-C.. 16

Fig. 3.4: Plan des vestiges vers 190 ap. J.-C. 17

Fig. 3.5: Plan des vestiges vers 200 ap. J.-C. 18

Fig. 3.6: Plan des vestiges vers 220 ap. J.-C. 19

Fig. 3.7: Plan des vestiges vers 260 ap. J.-C. 20

Fig. 3.8: Plan des vestiges dès 290 ap. J.-C. 21

2.2. Phases, états et locaux de la parcelle 2 22

Fig. 4.1: Parcelle 2, emplacement des niveaux de la période G. ... 22

Fig. 4.2. Parcelle 2, période F..... 23

Fig. 4.3: Parcelle 2, période E. 24

Fig. 4.4: Parcelle 2, période D-1. 25

Fig. 4.5: Parcelle 2, période D-2. 26

Fig. 4.6: Parcelle 2, période D-3. 27

Fig. 4.7: Parcelle 2, période C-1. 28

Fig. 4.8: Parcelle 2, période C-2. 29

Fig. 4.9: Parcelle 2, Période C-3. 30

Fig. 4.10: Parcelle 2, Période B. 31

2. Présentation des ensembles et analyse diachronique

3.1. Critère de sélection 32

Fig. 5: Unités de fouilles retenues, présentées par période.	32
3.2. Présentation des ensembles	37
3.2.1. Ensemble G - Période G (30 à 20/10 av. J.-C.).	37
Fig. 6.1: Coupe de référence nord-sud de la parcelle 2.	37
Fig. 6.2: Diagramme de Harris du sondage 10.	38
Fig. 6.3: Proportions choisies de l'ensemble G.	39
Fig. 6.4: Tableau des céramiques de l'ensemble G.	41
Fig. 6.5: Tableau des amphores de l'ensemble G.	43
3.2.2. Ensemble F - Période F (15-30/40 ap. J.-C.)	44
Fig. 7.1: Proportions choisies de l'ensemble F	44
Fig. 7.2: Tableau des céramiques de l'ensemble F.	46
3.2.3. Ensemble E-1 – Période E-1 (50 ap. J.-C.)	47
Fig. 8.1: Parcelle 2, période E-1.	47
Fig. 8.2: Coupe de référence nord-sud du portique.	48
Fig. 8.3: Proportions choisies de l'ensemble E-1.	49
Fig. 8.4: Tableau des céramiques de l'ensemble E-1.	51
Fig. 8.5: Tableau des amphores de l'ensemble E-1.	52
3.2.4. Ensemble E-2 - Période E-2 (50-80/90 (?) ap. J.-C.) ...	53
Fig. 9.1: Proportions choisies de l'ensemble E-2.	53
Fig. 9.2: Tableau des céramiques de l'ensemble E-2.	55
Fig. 9.3: Tableau des amphores de l'ensemble E-2.	56
3.2.5. Ensemble D-1 – Période D-1 (100/150 ap. J.-C.)	57
Fig. 10.1: Proportions choisies de l'ensemble D-1.	57
Fig. 10.2: Tableau des céramiques de l'ensemble D-1.	59
Fig. 10.3: Tableau des amphores de l'ensemble D-1.	63
3.2.6. Ensemble D-2 - Période D-2 (150/180 ap. J.-C.)	64
Fig. 11.1: Proportions choisies de l'ensemble D-2.	64
Fig. 11.2: Tableau des céramiques de l'ensemble D-2.	66
Fig. 11.3: Tableau des amphores de l'ensemble D-2.	69
3.2.7. Ensemble D-3 – Période D-3 (180 ap. J.-C.)	70
Fig. 12.1: Proportions choisies de l'ensemble D-3.	70
Fig. 12.2: Tableau des céramiques de l'ensemble D-3.	72

Fig. 12.3: Tableau des amphores de l'ensemble D-3.	77
3.2.8. Ensemble C-1 - Période C-1 (180 ap. J.-C.)	78
Fig. 13.1: Proportions choisies de l'ensemble C-1.	78
Fig. 13.2: Tableau des céramiques de l'ensemble C-1.....	80
Fig. 13.3: Tableau des amphores de l'ensemble C-1.	84
3.2.9. Ensemble C-2 - Période C-2 (180-200 ap. J.-C.)	85
Fig. 14.1: Proportions choisies de l'ensemble C-2.	85
Fig. 14.2: Tableau des céramiques de l'ensemble C-2.....	87
Fig. 14.3: Tableau des amphores de l'ensemble C-2.	92
3.2.10. Ensemble C-3 - Période C-3 (274 ap. J.-C.)	93
Fig. 15.1: Proportions choisies de l'ensemble C-3	93
Fig. 15.2: Tableau des céramiques de l'ensemble C-3.	95
Fig. 15.3: Tableau des amphores de l'ensemble C-3.	100
3.2.11. Ensemble B - Période B (330)	101
Fig. 16.1: Proportions choisies de l'ensemble B	101
Fig. 16.2: Tableau des céramiques de l'ensemble B.	103
Fig. 16.3: Tableau des amphores de l'ensemble B.	105
3.3. Évolution quantitative des catégories et formes céramiques	
3.3.2. Évolution des catégories	106
Fig. 17.1: Fines importées (PARFIN A, TSIT, TSGM, TSGE, TSAF)	106
Fig. 17.2: Communes importées (TNGC, RAEXR, EIRP).	108
Fig. 17.3: Fines régionales (CP A, CP B, TSI, TSITG, PGF).	110
Fig. 17.4: Céramiques à revêtement argileux (RALUIS, RAMET, RASABL, RANOIR, RAMAT).	112
Fig. 17.5: Communes engobées ou lissées (EIR, EIRN, MICAC, PGTN)	116
Fig. 17.6: Communes régionales oxydées et réduites (PCCRU, PCMOR, PC, PG, PGGROS).	118
Fig. 18: Tableau synthétique de l'évolution des catégories céramiques de la parcelle 2.	120
3.3.3. Les amphores	121
Fig. 19: Pourcentages des amphores.	121

3.3.4. Évolution des groupes de production.....	122
Fig. 20: Évolution des groupes de production.	122
3.3.5: Rapports entre quelques catégories choisies.....	123
Fig. 21.1: Évolution comparée des différentes catégories de sigillée.	123
Fig. 21.2: Évolution comparée des sigillées et de leurs imitations.	123
Fig. 21.3: Évolution comparée des sigillées, imitations de sigillées et revêtements argileux	124
Fig. 21.4: Évolution comparée des revêtements argileux.	124
Fig. 21.5: Évolution comparée des communes oxydées et des communes réduites.	125
3.3.6. Évolution des groupes morphologiques et de quelques formes	126
Fig. 22: Évolution des groupes morphologiques.	126
Fig. 23: Évolution des proportions des formes.	126
Fig. 24: Tableau synthétique de l'évolution des formes	135
Fig. 25.1: Évolution comparée des assiettes et des écuelles.	136
Fig. 25.2: Évolution comparée des coupes et des gobelets.	136
4. Céramique et fonction des locaux	
4.1.2. Définition groupes de catégories et catégories fonctionnelles	137
Fig. 26: Catégories fonctionnelles céramiques adoptées pour l'analyse des espaces de la parcelle 2.	137
4.2. Analyse fonctionnelle	138
4.2.1 Période D-1 (100/150 ap. J.-C.)	138
Fig. 27: Local 15 : pièce de séjour.	138
Fig. 28: Local 16 : atelier artisanal (boucherie, artisanat culinaire ?).	140
Fig. 29: Local 17: cuisine/zone de stockage.	143
Fig. 30: Local 18: artisanat culinaire, puis lieu de stockage ?	146
Fig. 31: Local 19: indéterminé.	149

Fig. 32: Local 21: échoppe, commerce alimentaire.....	152
Fig. 33: Local 24: pièce de séjour ?	155
Fig. 34: Local 25: couloir ou ruelle ?	158
Fig. 35.1: Proposition d'attribution fonctionnelle des locaux de la période D-1a.	161
Fig. 35.2: Proposition d'attribution fonctionnelle des locaux de la période D-1b.	162
Fig. 35.3: Proposition d'attribution fonctionnelle des locaux de la période D-1c.	163
Fig. 35.4: Proposition d'attribution fonctionnelle des locaux de la période D-1d.	164
4.2.2. Période D-2 (150/180 ap. J.-C.)	165
Fig.36:Local 16: atelier artisanal (boucherie, artisanat culinaire ?).	165
Fig.37.1:Local 17a: indéterminé.	168
Fig.37.2: Local 17b: cuisine/stockage.	171
Fig.38: Local 18: pièce de séjour.	174
Fig.39: Local 20: indéterminé.	177
Fig.40: Local 21: échoppe, commerce alimentaire.	180
Fig.41: Local 22: cour.	183
Fig.42: Local 24: pièce de séjour.	186
Fig.43: Local 26: indéterminé.	189
Fig.44: Proposition d'attribution fonctionnelle des locaux de la période D-2.	192
4.2.3. Période D-3 (180 ap. J.-C.)	193
Fig. 45: Local 16: atelier artisanal (boucherie, artisanat culinaire ?).	193
Fig. 46: Local 17a et local 24:indéterminé (stockage ?).	196
Fig. 47: Local 17b: atelier artisanal (boucherie, artisanat culinaire ?).	199
Fig. 48: Local 18: atelier artisanal (forge).	202
Fig. 49: Local 19: indéterminé.	205

Fig. 50: Local 20: indéterminé (cuisine ?).	208
Fig. 51: Local 21: échoppe/commerce alimentaire.	211
Fig. 52: Local 22: cour.	214
Fig. 53: Proposition d'attribution fonctionnelle des locaux de la période D-3.	217
4.2.4. Période C-1 (180 ap. J.-C.)	218
Fig. 54: Local 3: stockage ?	218
Fig. 55: Local 5: indéterminé.	221
Fig. 56: Local 12 : cuisine ?	224
Fig. 57: Local 13 : stockage.	227
Fig. 58: Local 14: indéterminé.	230
Fig. 59: Local 19: cour.	233
Fig. 60: Proposition d'attribution fonctionnelle des locaux de la période C-1.	236
4.2.5. Période C-2 (180/200 ap. J.-C.)	237
Fig. 61: Locaux 4 et 5: couloir et indéterminé.	237
Fig. 62: Locaux 12: atelier artisanal (artisanat culinaire ?).	240
Fig. 63: Locaux 14: cuisine.	243
Fig. 64: Proposition d'attribution fonctionnelle des locaux de la période C-2	246
4.2.5. Période C-3 (330 ap. J.-C.)	247
Fig. 65: Local 3: stockage.	247
Fig. 66: Local 5: Indéterminé (culinaire ?).	250
Fig. 67: Local 6: cour.	253
Fig. 68: Local 8: séjour ?	256
Fig. 69: Local 9: indéterminé (domestique ?).	259
Fig. 70: Local 11: séjour.	262
Fig. 71: Proposition d'attribution fonctionnelle des locaux de la période C-3.	265

4.2. Conclusions, limites et synthèse de l'approche

Fig. 72: Critères d'identification des espaces par leurs aménagements et leur mobilier céramique. 266

Catalogue

Période G, (20 à 20/10 av. J.-C.), planche 1.1.....	268
Période F, (15-30/40 ap. J.-C.), planche 2.1	270
Période F, (15-30/40 ap. J.-C.), planche 2.2	272
Période E-1, (50 ap. J.-C.), planche 3.1.....	272
Période E-1, (50 ap. J.-C.), planche 3.2.....	274
Période E-2, (50 à 80/90 (?) ap. J.-C.), planche 4.1	276
Période E-2, (50 à 80/90 (?) ap. J.-C.), planche 4.2	278
Période D-1, (100/150 ap. J.-C.), planche 5.1	280
Période D-1, (100/150 ap. J.-C.), planche 5.2	282
Période D-1, (100/150 ap. J.-C.), planche 5.3	284
Période D-1, (100/150 ap. J.-C.), planche 5.4	286
Période D-1, (100/150 ap. J.-C.), planche 5.5	288
Période D-1, (100/150 ap. J.-C.), planche 5.6	290
Période D-2, (150/180 ap. J.-C.), planche 6.1	294
Période D-2, (150/180 ap. J.-C.), planche 6.2	296
Période D-2, (150/180 ap. J.-C.), planche 6.3	298
Période D-2, (150/180 ap. J.-C.), planche 6.4	300
Période D-2, (150/180 ap. J.-C.), planche 6.5	302
Période D-3, (180 ap. J.-C.), planche 7.1.....	304
Période D-3, (180 ap. J.-C.), planche 7.2.....	306
Période D-3, (180 ap. J.-C.), planche 7.3.....	308
Période D-3, (180 ap. J.-C.), planche 7.4.....	310
Période D-3, (180 ap. J.-C.), planche 7.5.....	312
Période D-3, (180 ap. J.-C.), planche 7.6.....	314
Période D-3, (180 ap. J.-C.), planche 7.7.....	316
Période D-3, (180 ap. J.-C.), planche 7.8.....	318
Période C-1, (180 ap. J.-C.), planche 8.1	320
Période C-1, (180 ap. J.-C.), planche 8.2.....	322

Période C-1, (180 ap. J.-C.), planche 8.3	324
Période C-1, (180 ap. J.-C.), planche 8.4	326
Période C-1, (180 ap. J.-C.), planche 8.5	328
Période C-1, (180 ap. J.-C.), planche 8.6	330
Période C-1, (180 ap. J.-C.), planche 8.7	332
Période C-2, (180/200 ap. J.-C.), planche 9.1	334
Période C-2, (180/200 ap. J.-C.), planche 9.2	336
Période C-2, (180/200 ap. J.-C.), planche 9.3	338
Période C-2, (180/200 ap. J.-C.), planche 9.4	340
Période C-2, (180/200 ap. J.-C.), planche 9.5	342
Période C-2, (180/200 ap. J.-C.), planche 9.6	344
Période C-2, (180/200 ap. J.-C.), planche 9.7	346
Période C-2, (180/200 ap. J.-C.), planche 9.8	348
Période C-2, (180/200 ap. J.-C.), planche 9.9	350
Période C-2, (180/200 ap. J.-C.), planche 9.10.....	352
Période C-2, (180/200 ap. J.-C.), planche 9.11.....	354
Période C-3, (274 ap. J.-C.), planche 10.1	356
Période C-3, (274 ap. J.-C.), planche 10.2	358
Période C-3, (274 ap. J.-C.), planche 10.3	360
Période C-3, (274 ap. J.-C.), planche 10.4	362
Période C-3, (274 ap. J.-C.), planche 10.5	364
Période C-3, (274 ap. J.-C.), planche 10.6	366
Période C-3, (274 ap. J.-C.), planche 10.7	368
Période B, (330 ap. J.-C.), planche 11.1	370
Période B, (330 ap. J.-C.), planche 11.2	372
Période B, (330 ap. J.-C.), planche 11.3	374
Période B, (330 ap. J.-C.), planche 11.4	376
Références des figures	378

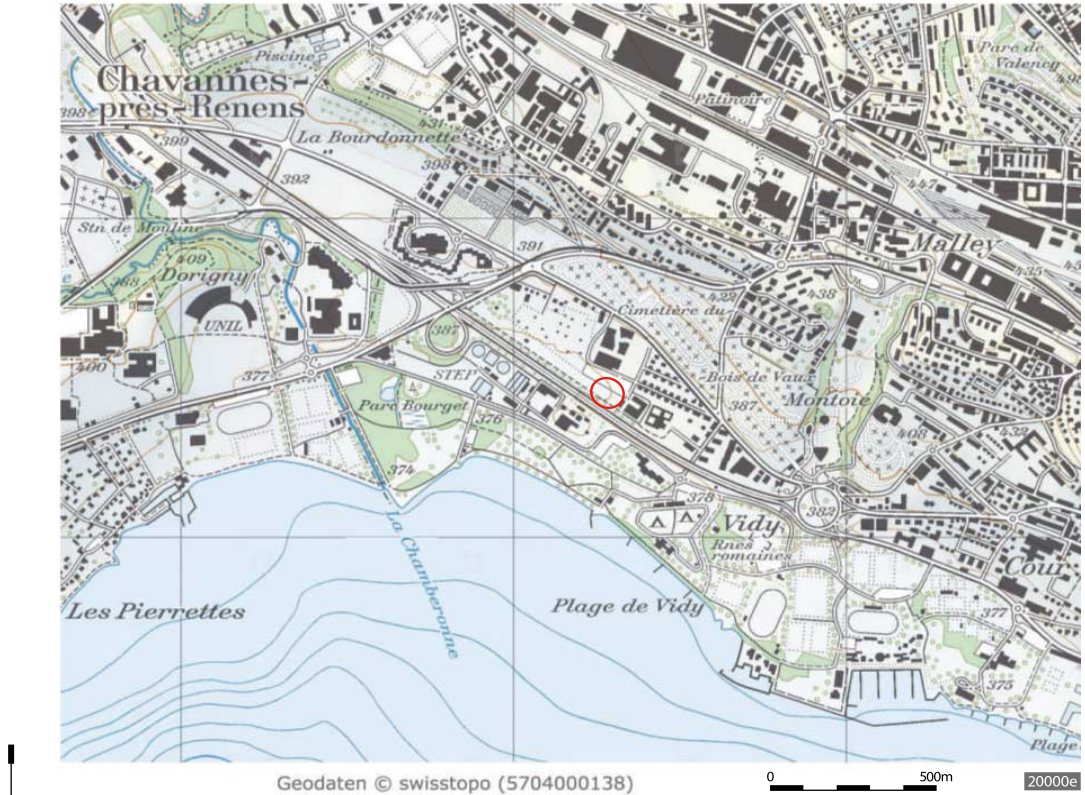
2. Vidy Boulodrome, les autres bâtiments et la parcelle 2

2.1. Les fouilles de Vidy-Boulodrome

Fig. 1 : Chronologie relative et chronologie absolue de la parcelle 2.

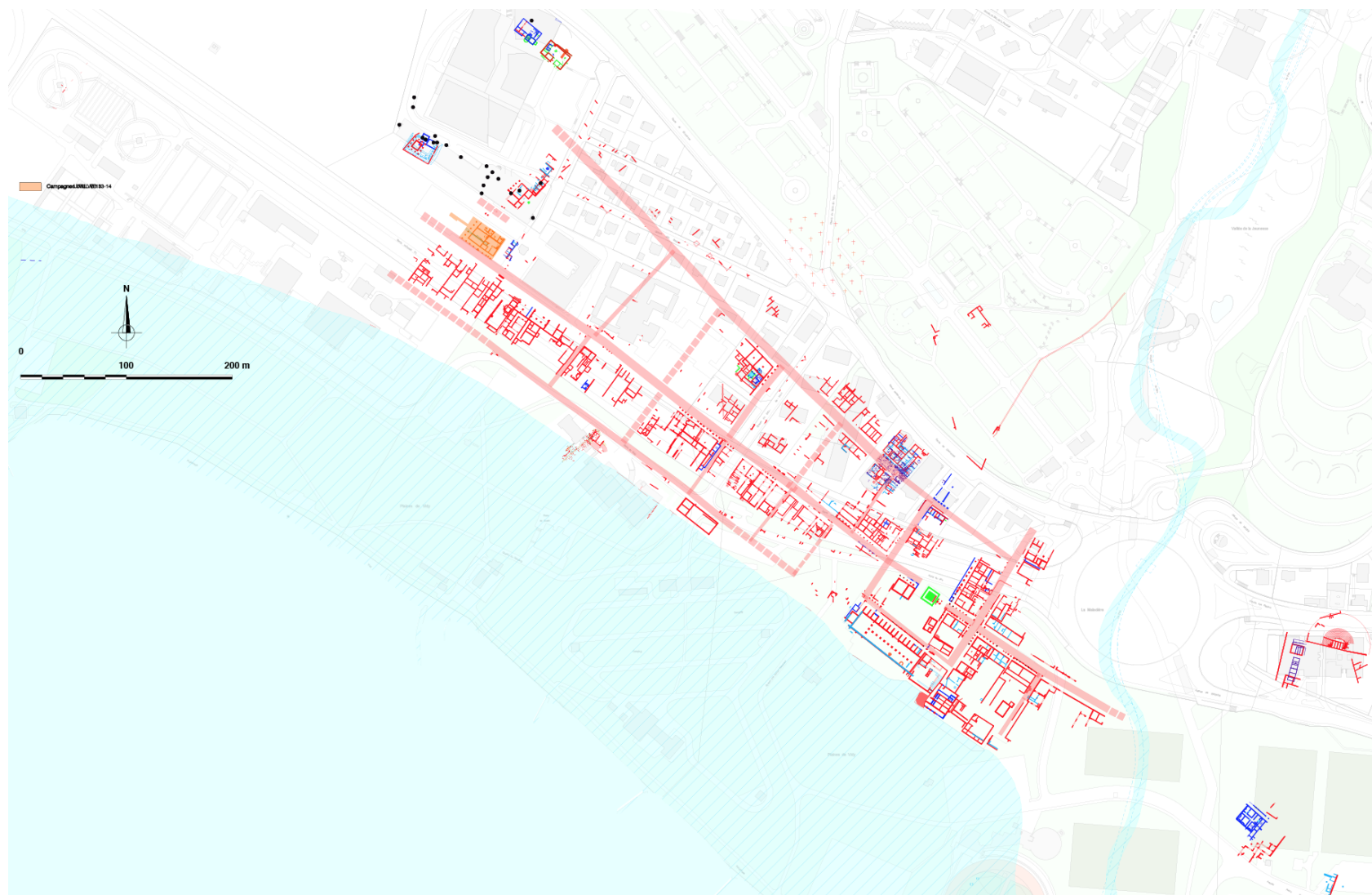
Chronologie relative	Datations des ensembles	Début des périodes (sans états ANT)
Période G	30 à 20/10 avant J.-C.	30/20 avant J.-C.
Période F	15 à 30/40 après J.-C.	Vers 60 après J.-C. ?
Période E-1	50 après J.-C.	Vers 70 après J.-C. ?
Période E-2	50 à 80/90 (?) après J.-C.	Vers 80 après J.-C. ?
Période D-1	100/150 après J.-C.	Vers 90/100 après J.-C. ?
Période D-2	150/180 après J.-C.	Vers 150/160 après J.-C.
Période D-3	180 après J.-C.	Vers 180/190 après J.-C.
Période C-1	180 après J.-C.	Vers 190/200 après J.-C.
Période C-2	180/200 après J.-C.	Vers 230/240 après J.-C.
Période C-3	274 après J.-C.	Vers 250/270 après J.-C.
Période B	330 après J.-C.	Vers 280/300 après J.-C.

Fig. 2.1: Situation du site de Vidy-Boulodrome.



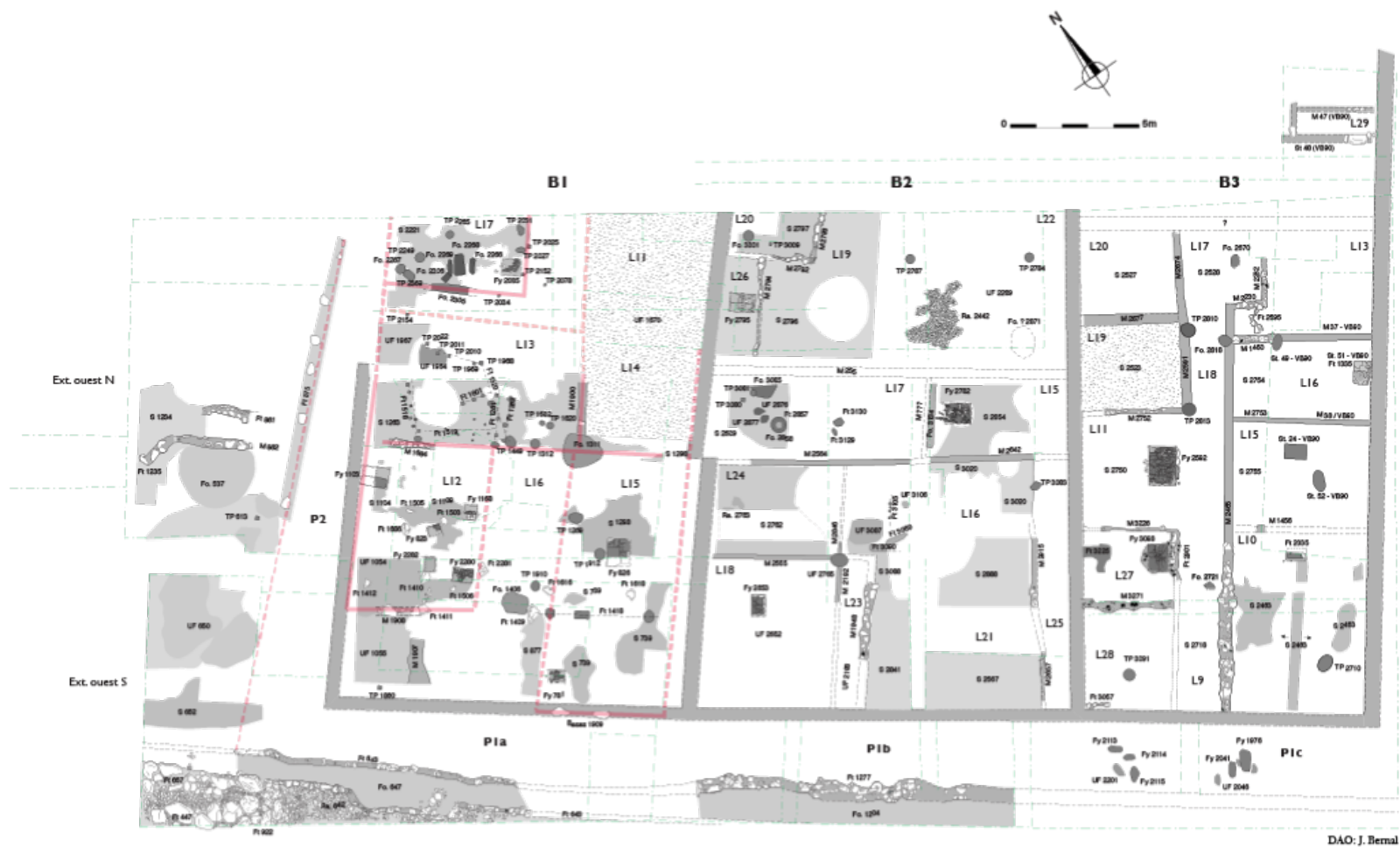
Échelle : 1/20000 e
Échelle : 1/10000 e
Crédit photo : Swi sstopo

Fig. 2.2: Plan général des vestiges du *vicus* de *Lousonna*, et situation du site de Vidy-Boulodrome (en orange).



2.2. Description sommaire et évolution des vestiges des quatre parcelles

Fig. 3.1: Plan des vestiges vers 100 ap. J.-C. Échelle 1:150.



DAO: J. Bernal

Fig. 3.2: Plan des vestiges vers 150 ap. Échelle 1:150.



Fig. 3.3: Plan des vestiges vers 180 ap. J.-C. Échelle 1:150.

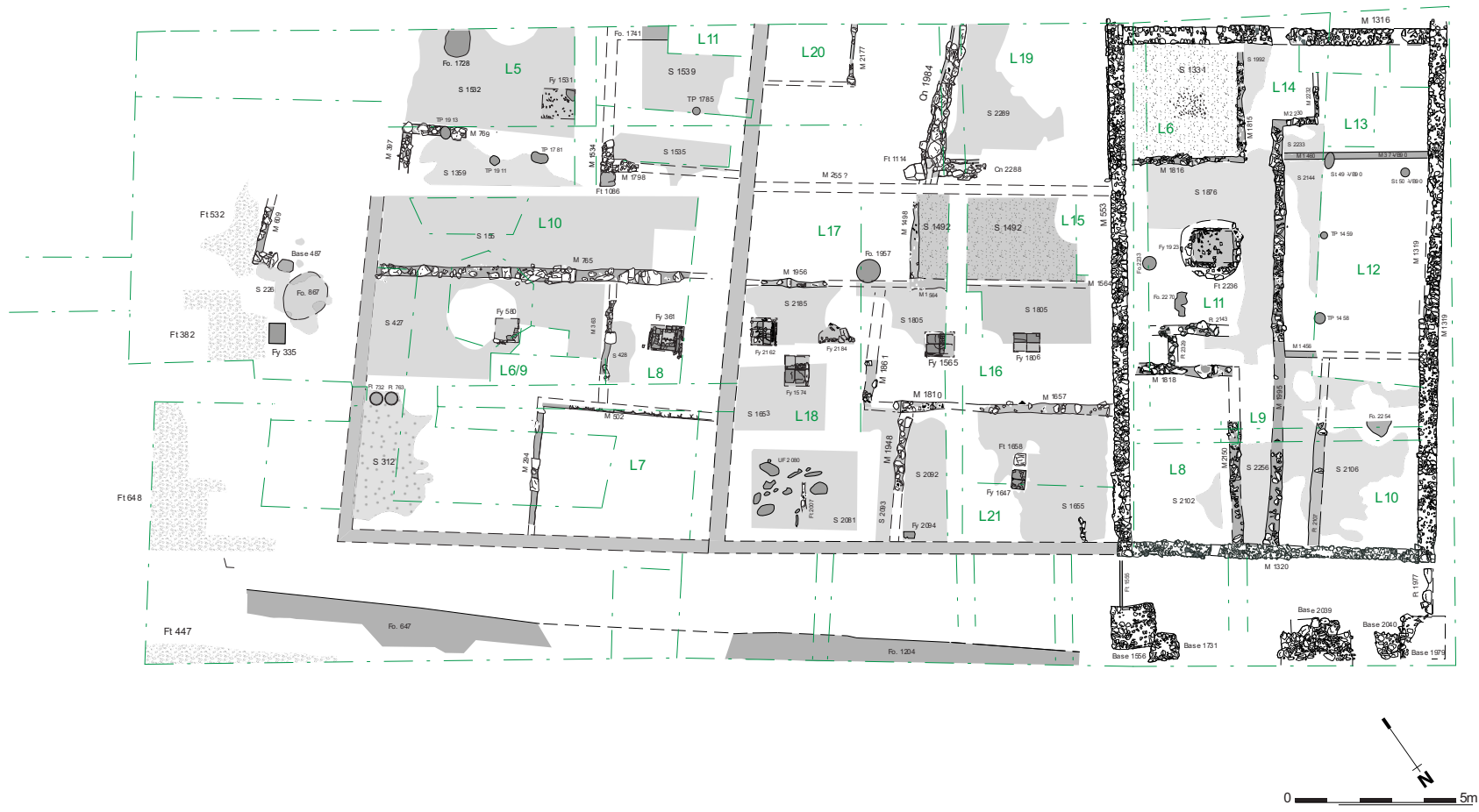


Fig. 3.5: Plan des vestiges vers 200 ap. J.-C. Échelle 1:150.



Fig. 3.6: Plan des vestiges vers 220 ap. J.-C. Échelle 1:150

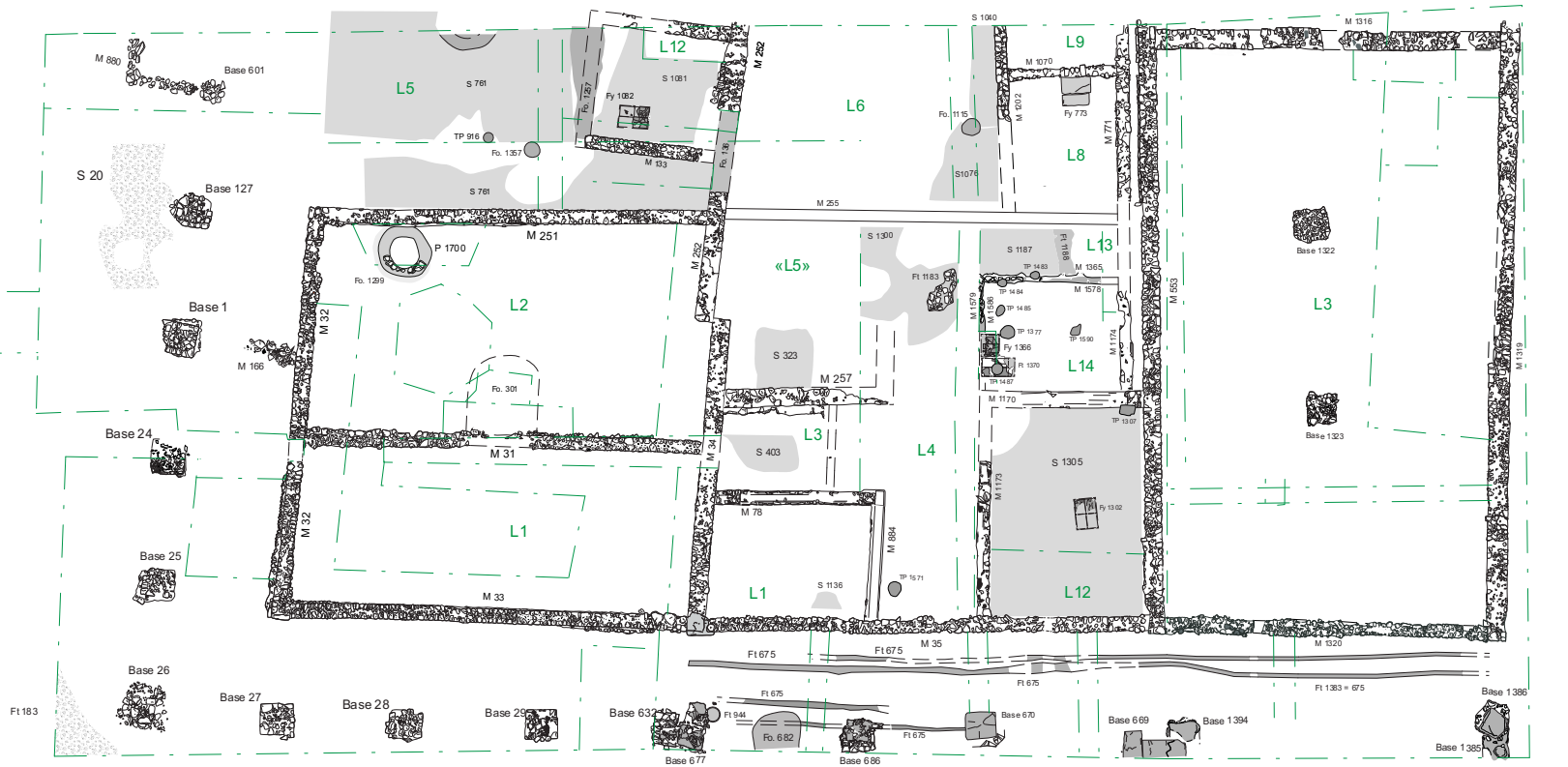


Fig. 3.7: Plan des vestiges vers 260 ap. J.-C. Échelle 1:150.



Fig. 3.8: Plan des vestiges entre 290 et la fin du IVe siècle de notre ère. Échelle 1:150.



Fig. 4.2. Parcelle 2, période F (15-40/40 ap. J.-C.).

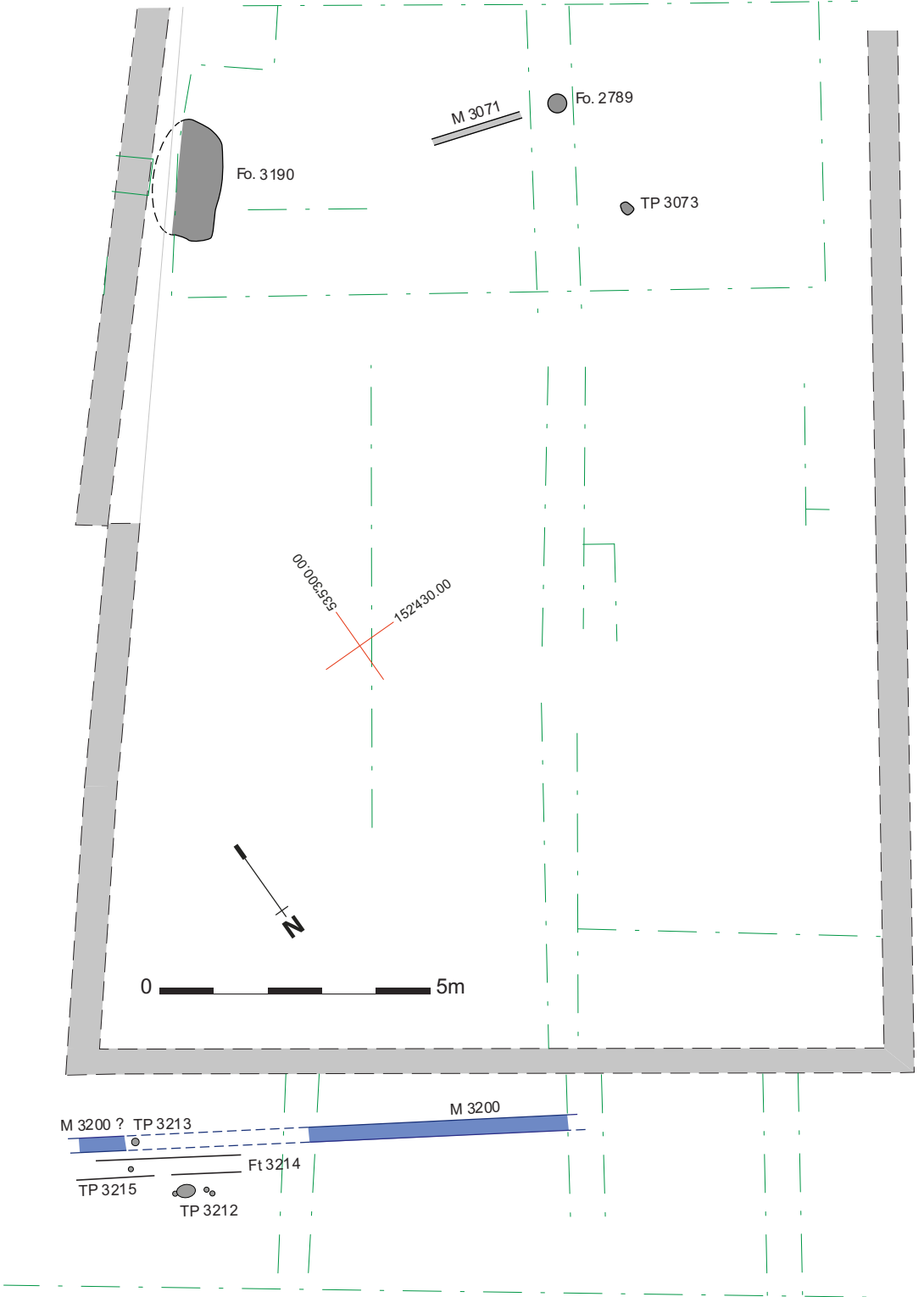


Fig. 4.3: Parcelle 2, période E (50-80/90 (?) ap. J.-C.).

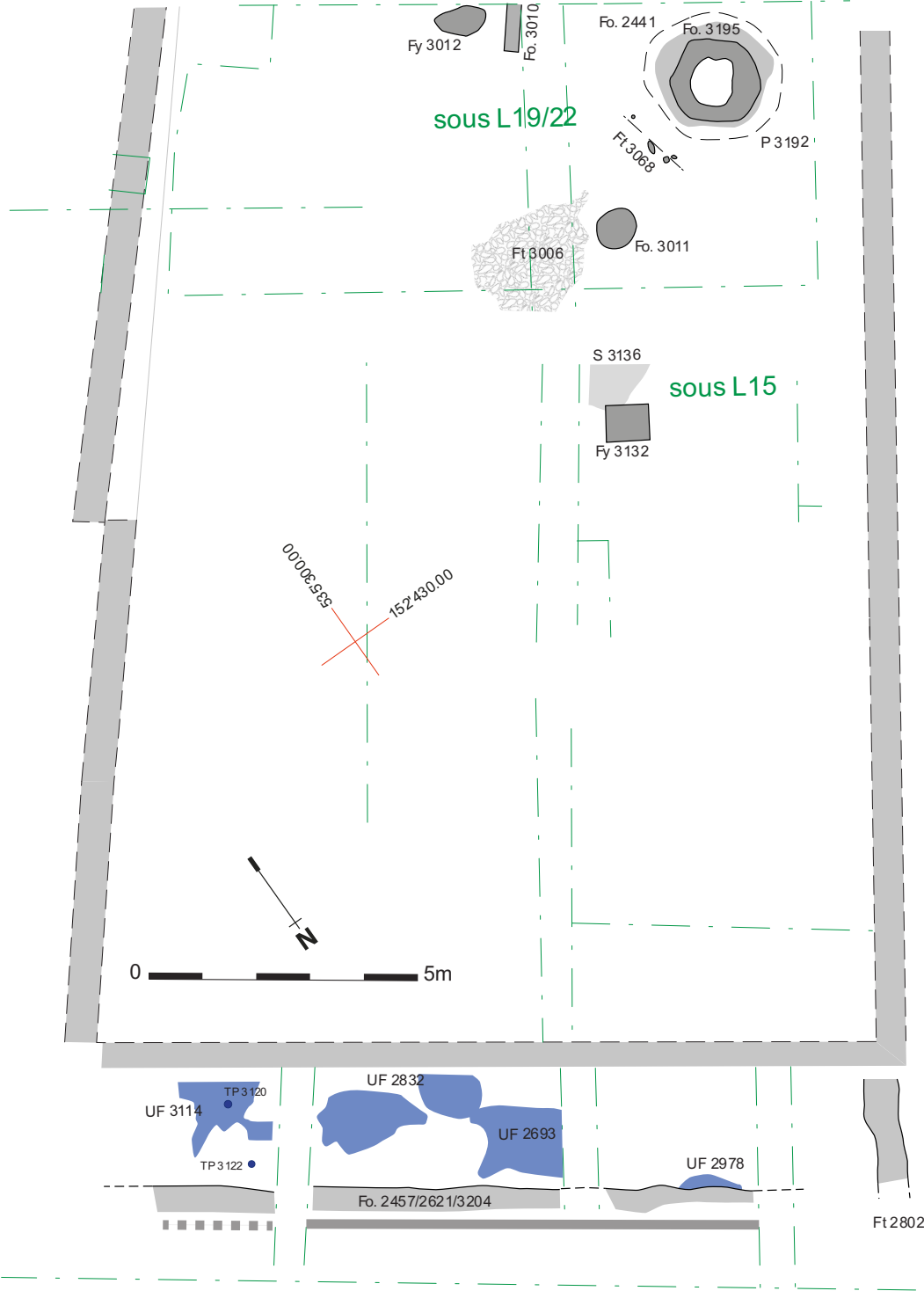


Fig. 4.4: Parcelle 2, période D-1 (100/150 ap. J.-C.).

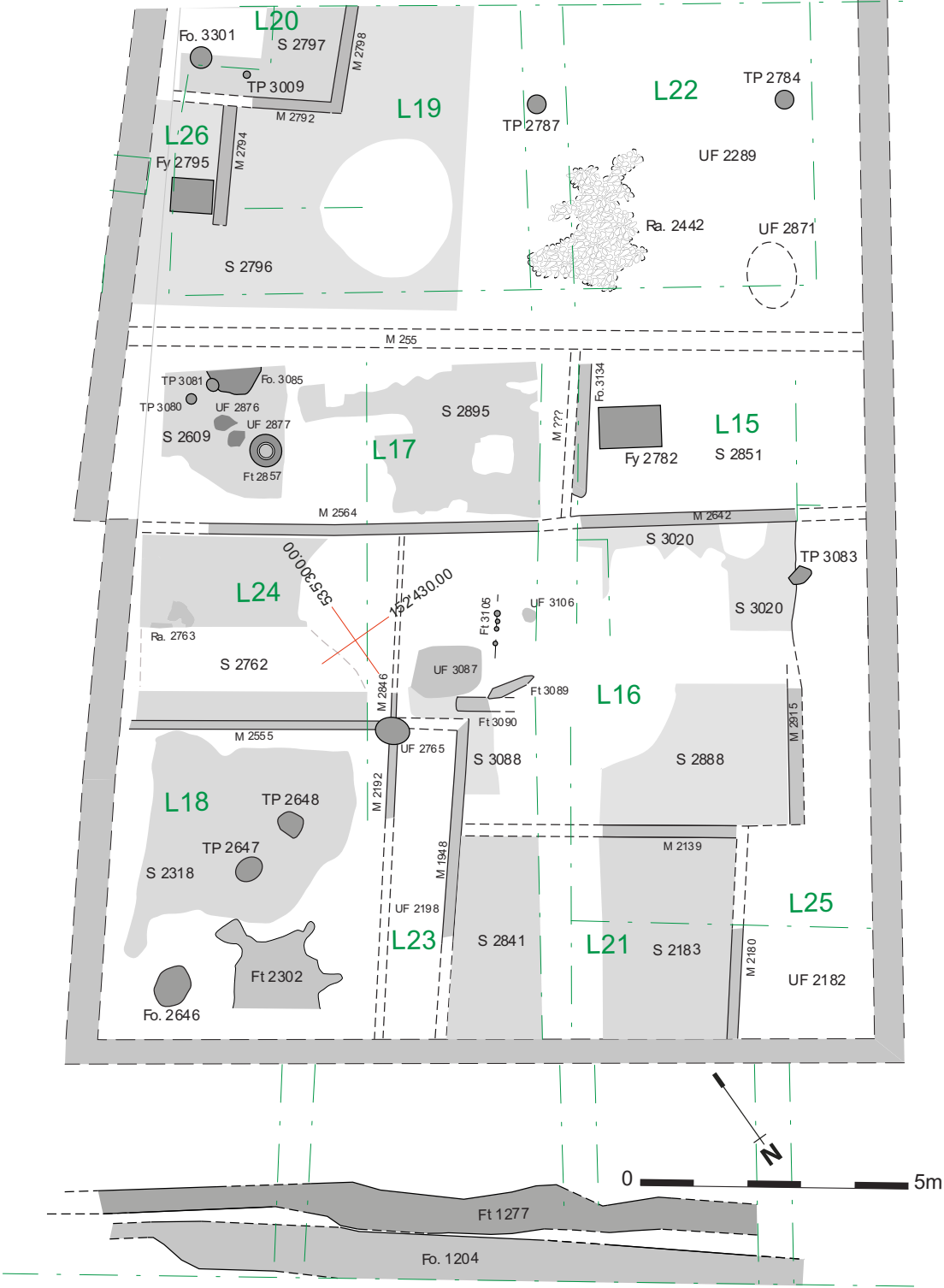


Fig. 4.5: Parcelle 2, période D-2 (150/180 ap. J.-C.).

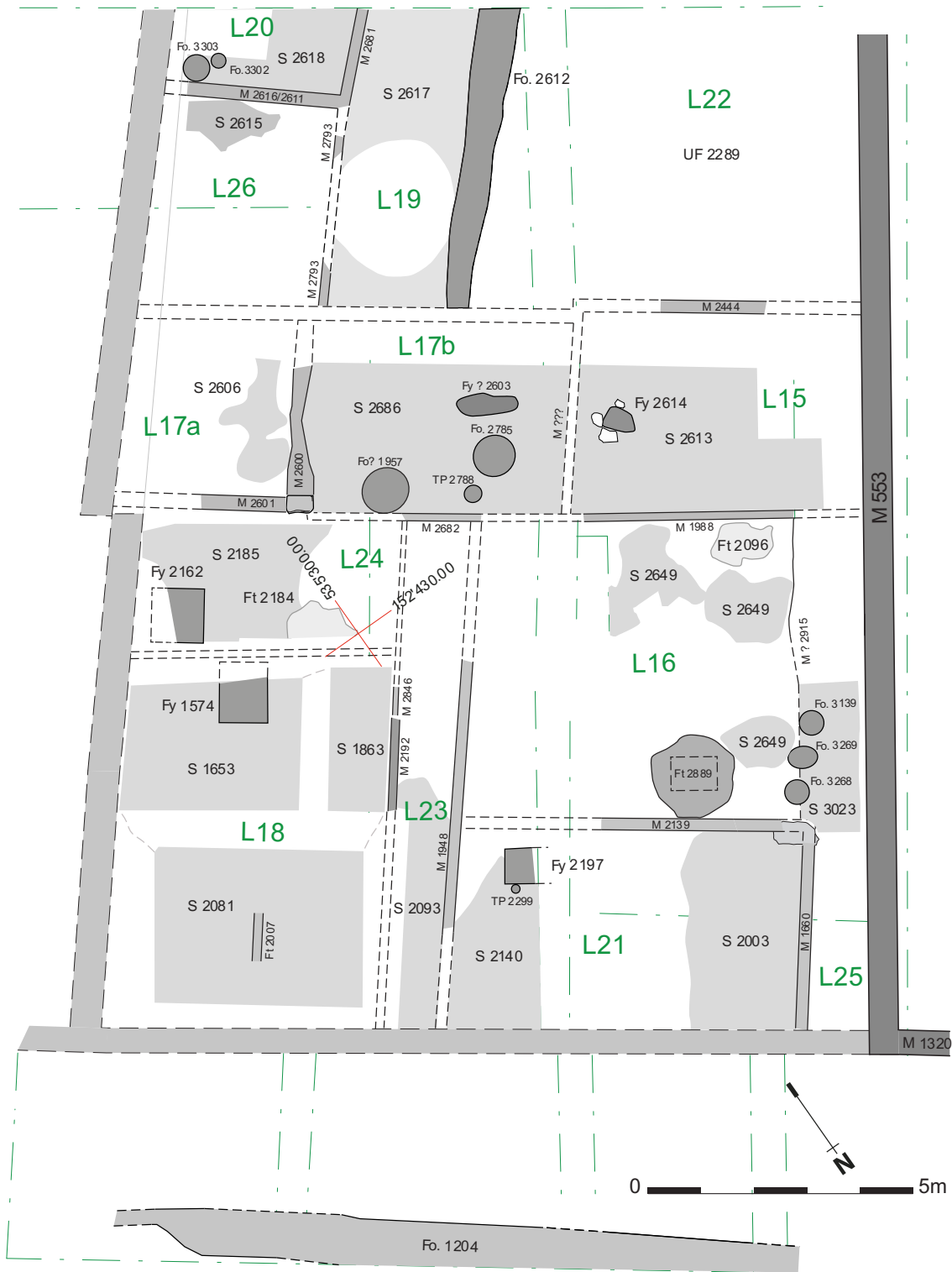


Fig. 4.6: Parcelle 2, période D-3 (180 ap. J.-C.).

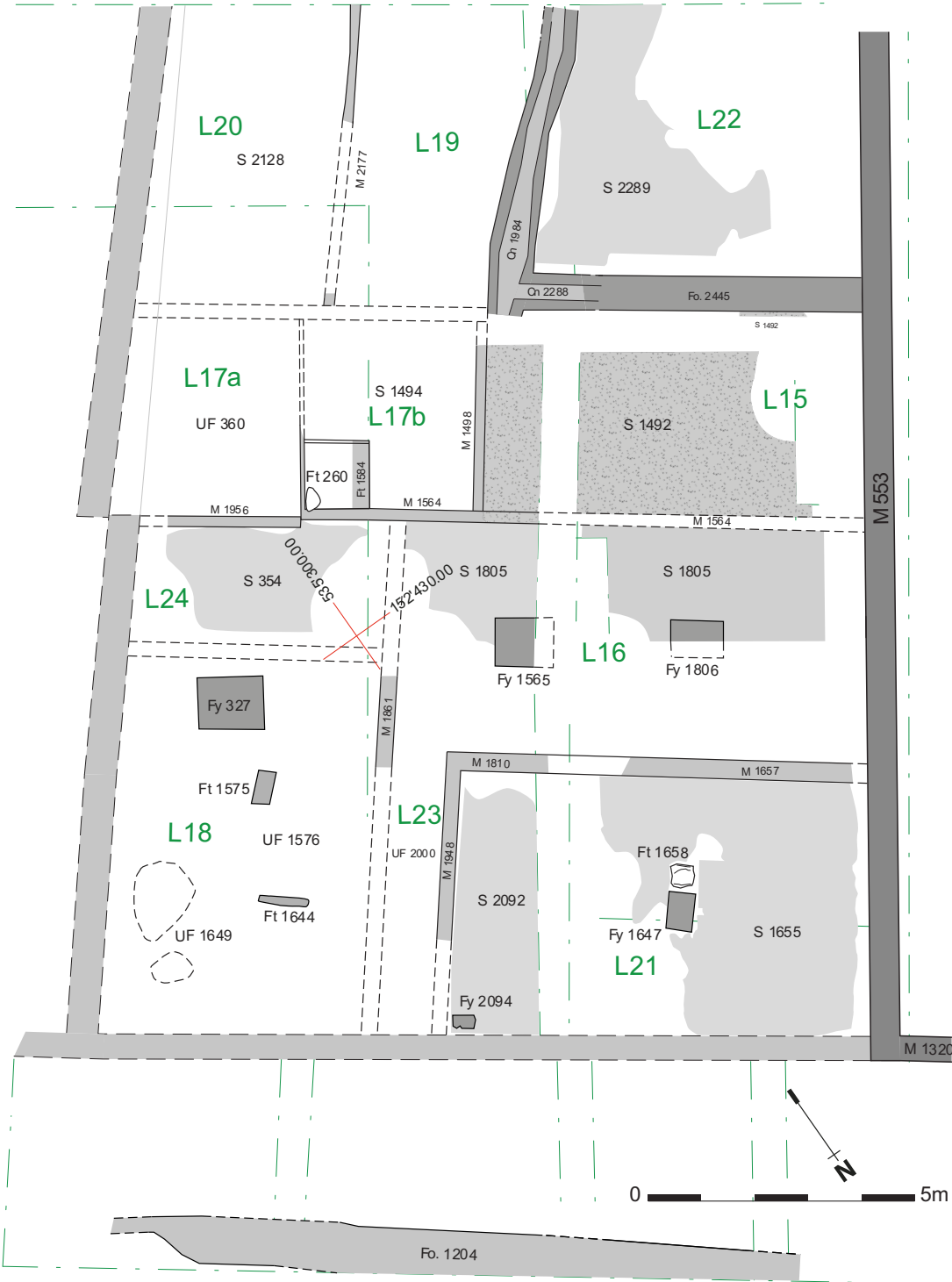


Fig. 4.7: Parcelle 2, période C-1 (180 ap. J.-C.).

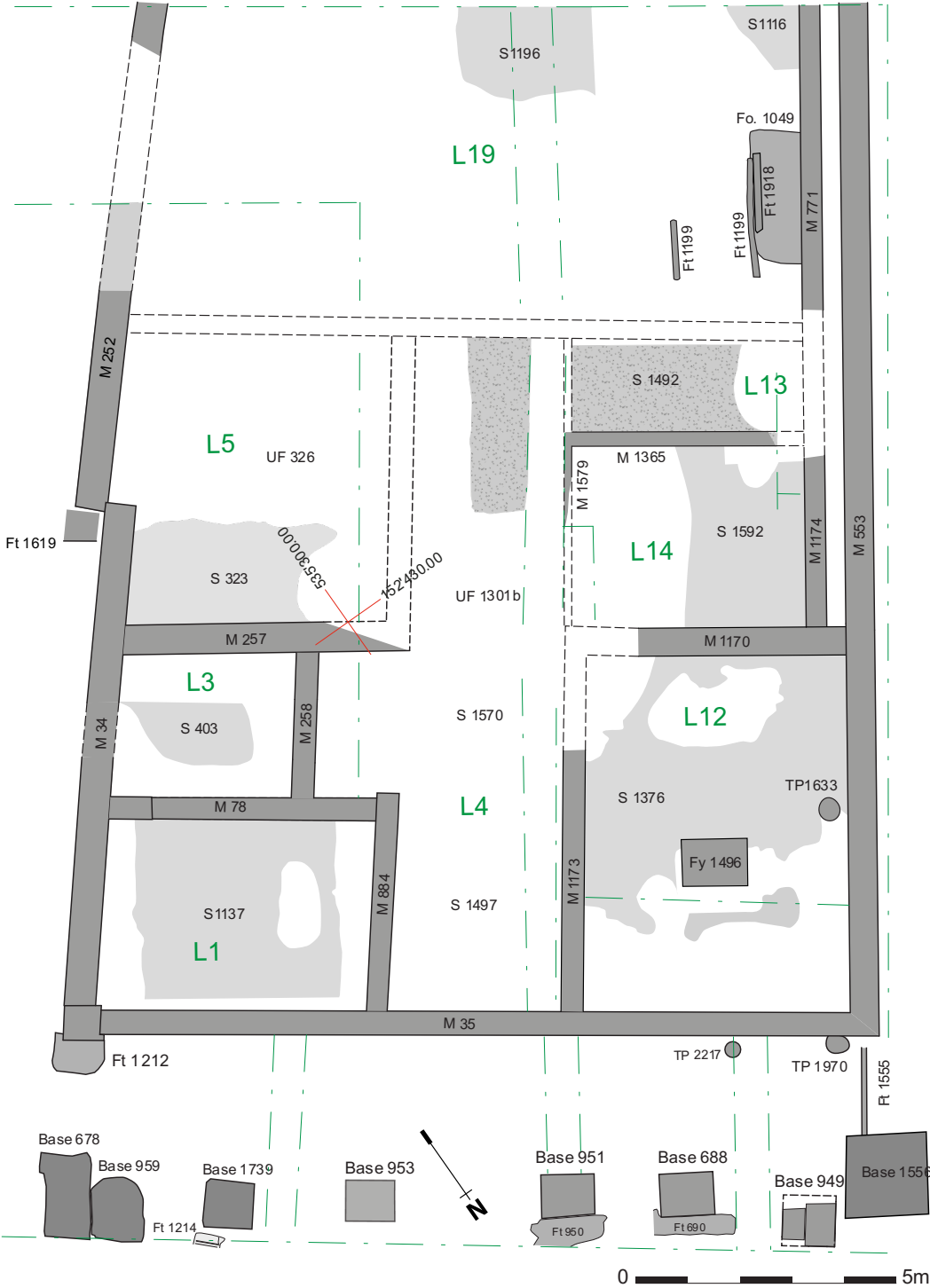


Fig. 4.8: Parcelle 2, période C-2 (180/200 ap. J.-C.).



Fig. 4.9: Parcelle 2, Période C-3 (274 ap. J.-C.).

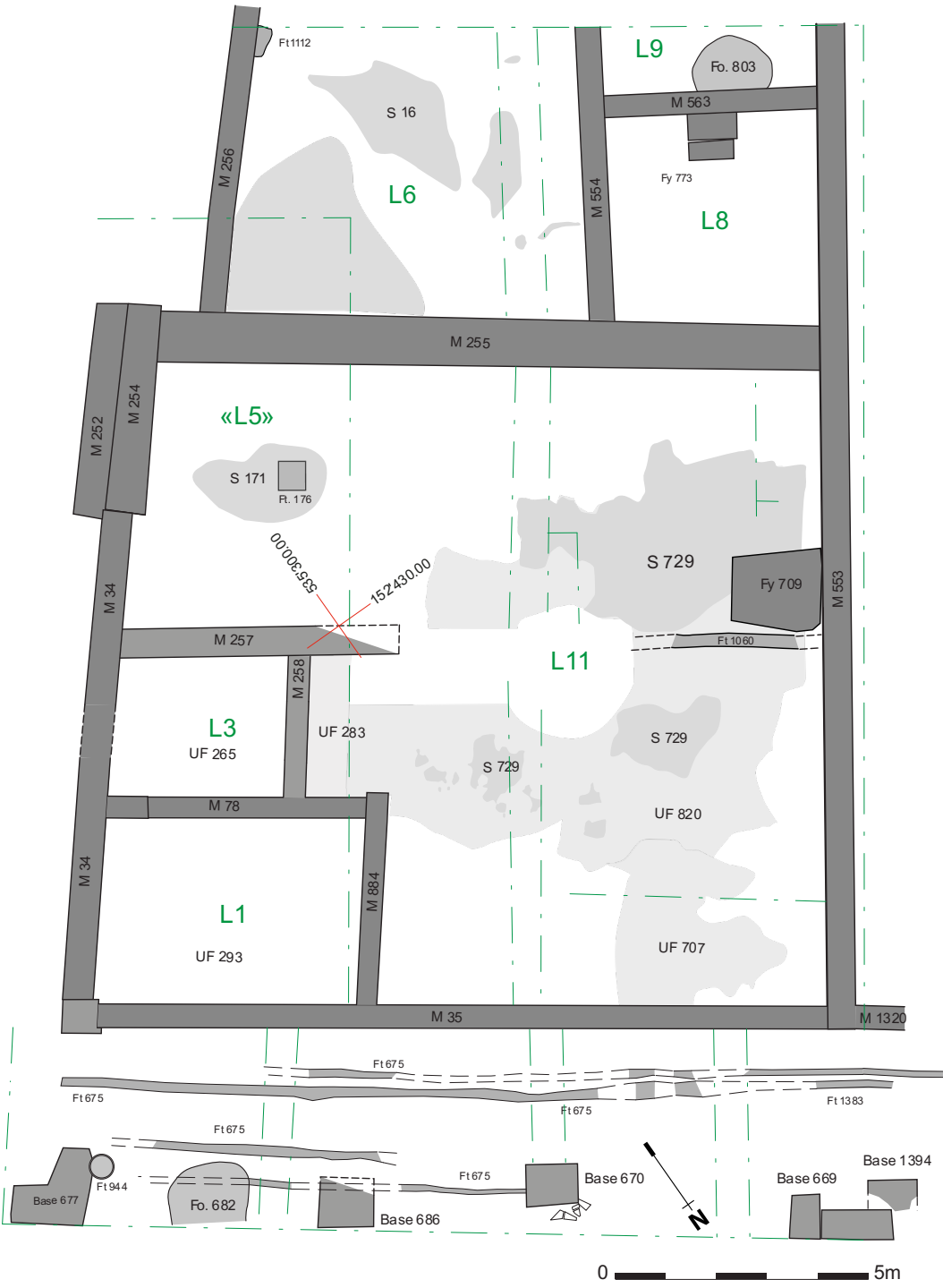
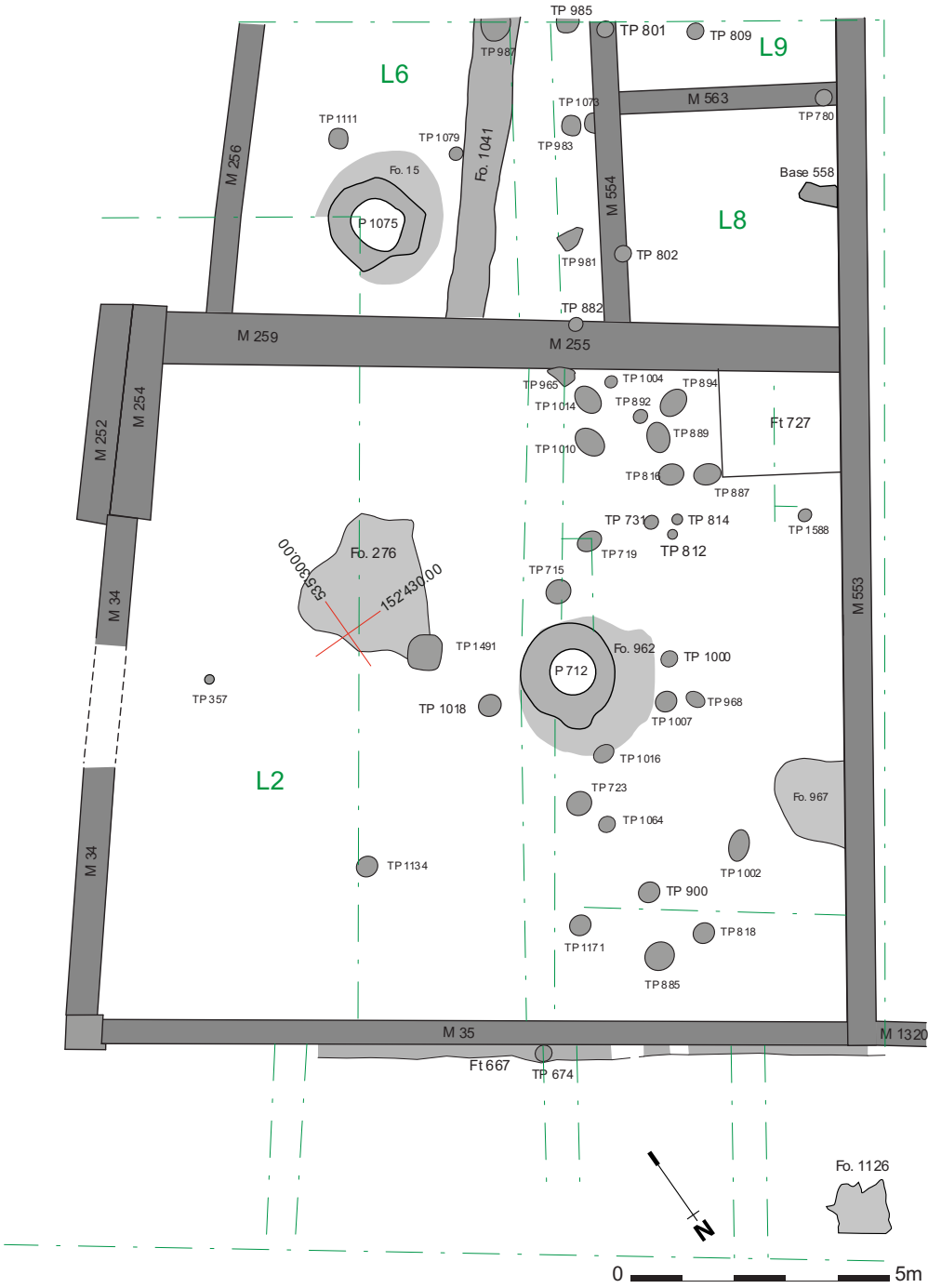


Fig. 4.10: Parcelle 2, Période B (330 ap. J.-C.).



3. Présentation des ensembles et analyse diachronique

3.1. Critère de sélection

Fig. 5: Unités de fouilles retenues, présentées par période.

Période G

UF retenues	Phase	Localisation	Années
852	/	/	VB14, 15,16, 19
2772	/	Sondage 10	VB18
2843	/	Sondage 10	VB18
2848	/	Sondage 10	VB18
2883	/	Sondage 10	VB18
3146	/	Sous L19	VB19

Période F

UF retenues	Phase	Localisation	Années
2683	C/0	Sous L19	VB18, 19
2767	/	Sondage 10	VB18
3184	D	Sous L19	VB19

Période E-1

UF retenues	Phase	Localisation	Années
2981	O/D	ES b, S11	VB19

Période E-2

UF retenues	Phase	Localisation	Années
2451	O/D	ES b	VB18
2458	O/D	ES b	VB18, 19
2991	O/D	ES b, S12	VB19

Période D-1

UF retenues	Phase	Localisation	Années
2910	O	Sous L16	VB18, 19
2320	O	Sous L16	VB17

Période D-2

UF retenues	Phase	Localisation	Années
2089	O	L16	VB17 à 19

Période D-3

UF retenues	Phase	Localisation	Années
1563	O	L16	VB16 à 18
1599	O	L16	VB16, 17
1656	C/O	L16	VB16, 17
1806	C/O	L16	VB16, 17
1808	C/O	L16	VB16, 17

Période C-1

UF retenues	Phase	Localisation	Années
1042	D	L19	VB15, 17, 18
1044	D	L19	VB15, 17
1046	D	L19	VB15, 17
1048	D	L19	VB15, 17
1113	D	L19	VB15, 17, 18, 19
1117	D	L19	VB15, 17
1118	D	L19	VB15, 17
1197	D	L19	VB15, 17
1919	D	L19	VB17

Période C-2

UF retenues	Phase	Localisation	Années
707	D	L4/5	VB14
820	D	L4/5	VB14, 15

Période C-3

UF retenues	Phase	Localisation	Années
705	O/D	L11	VB14, 15

Période B

UF retenues	Phase	Localisation	Années
555	D	L8	VB14, 15, 17, 18

3.2. Présentation des ensembles

3.2.1. Ensemble G - Période G (30 à 20/10 av. J.-C.) (Pl. 1.1)

Fig. 6.1: Coupe de référence nord-sud de la parcelle 2.

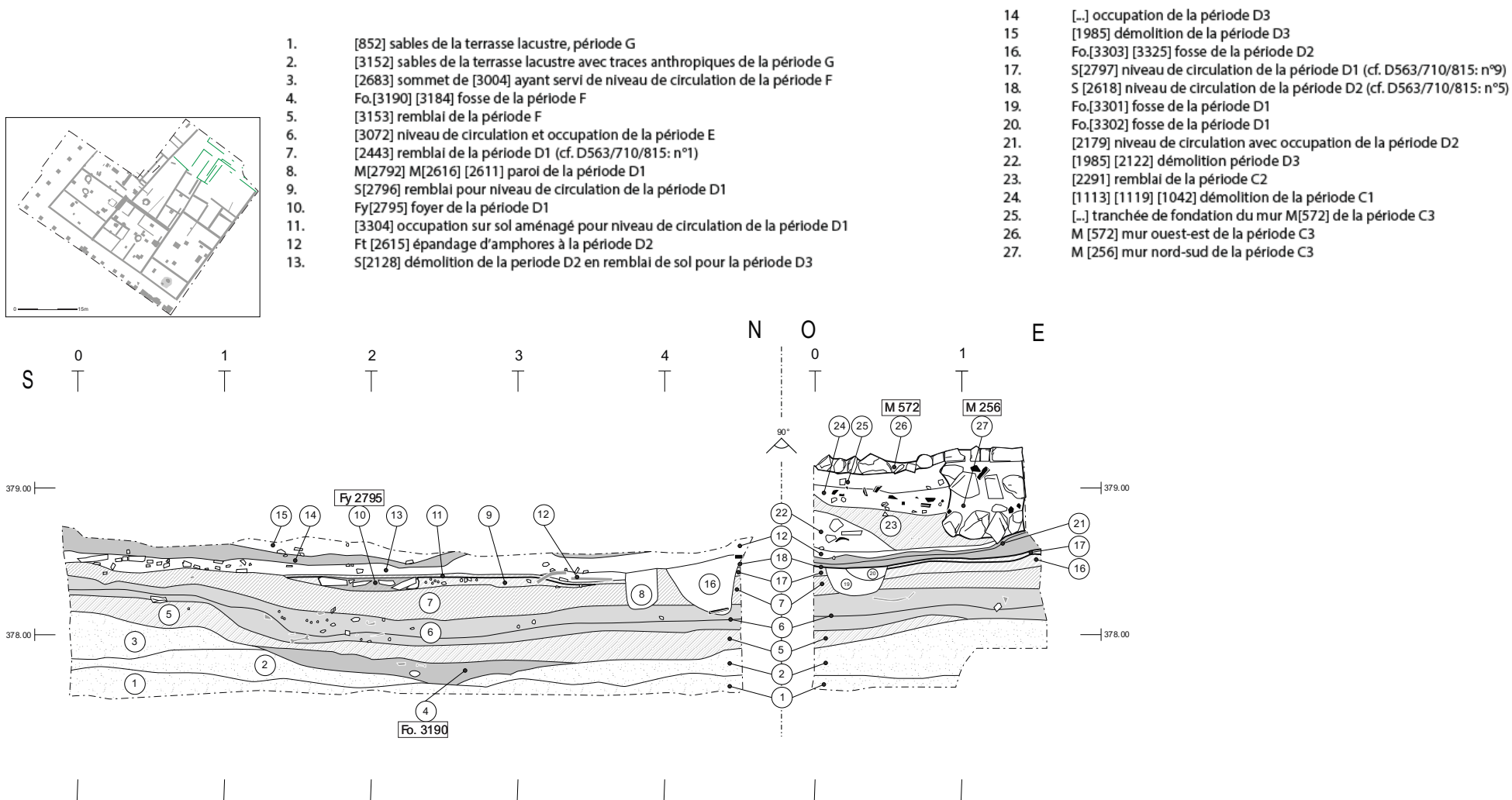


Fig. 6.2: Diagramme de Harris du sondage 10.

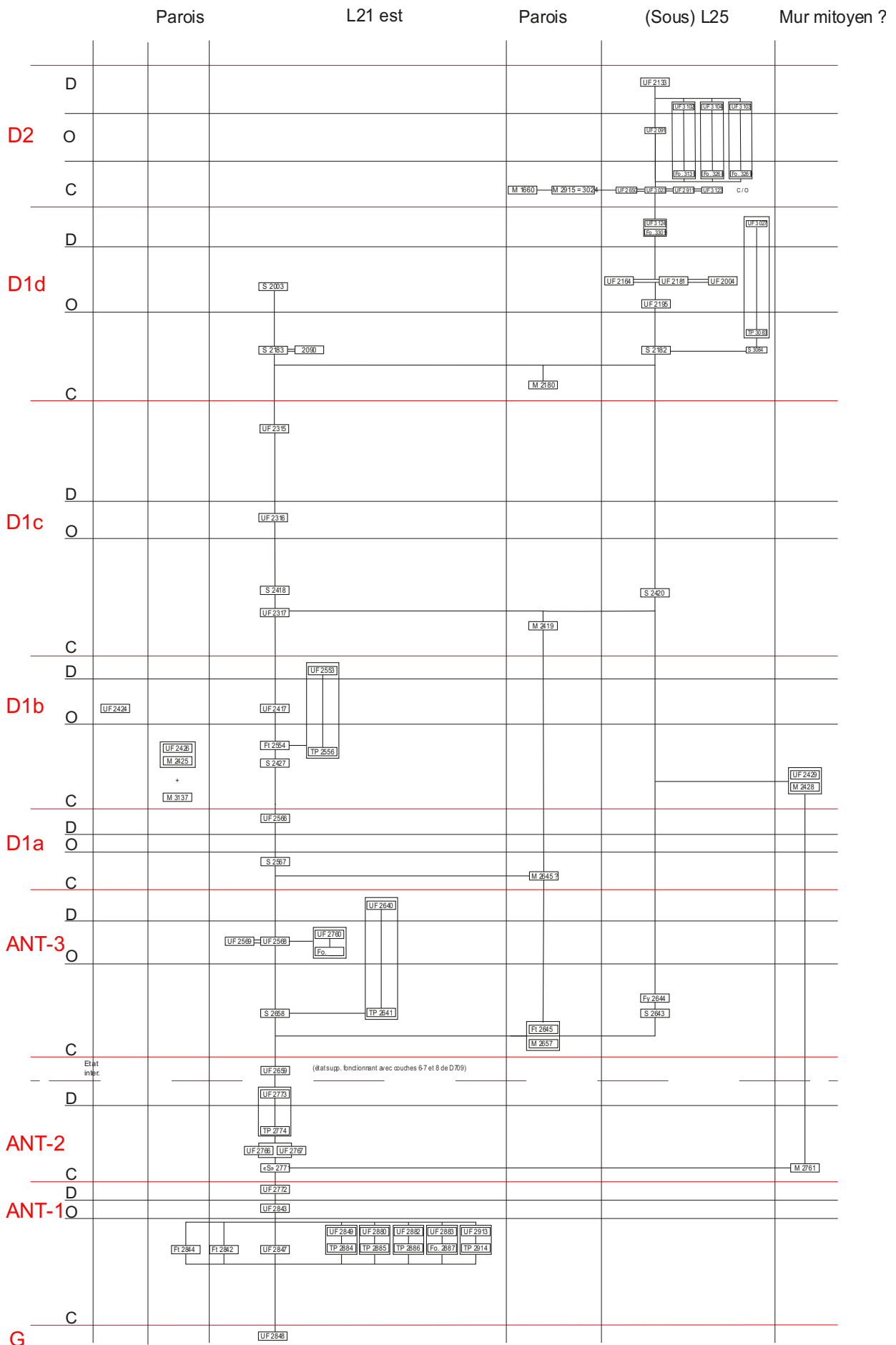
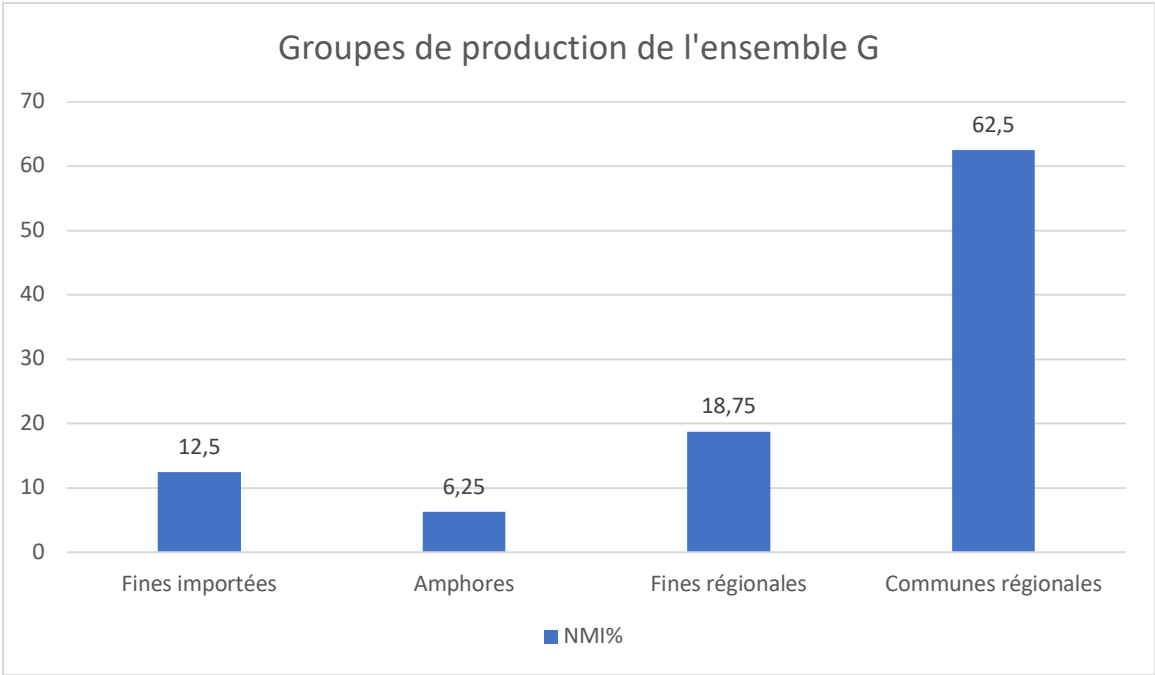
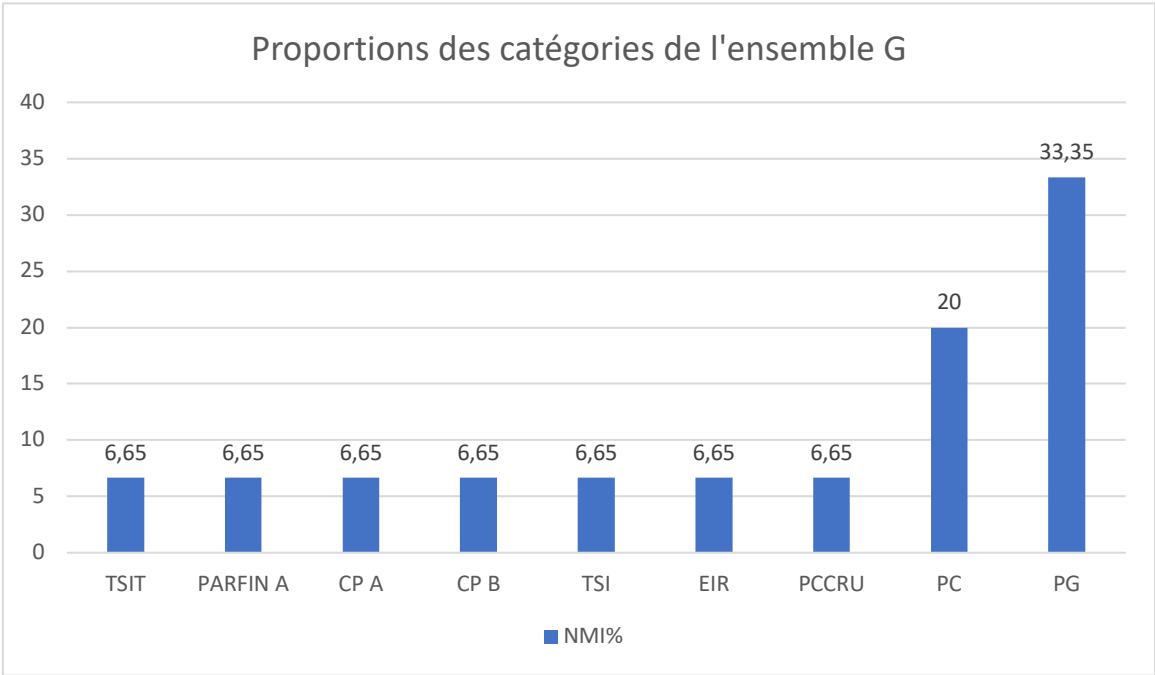


Fig. 6.3: Proportions choisies de l'ensemble G (NMI exprimé en pourcents).



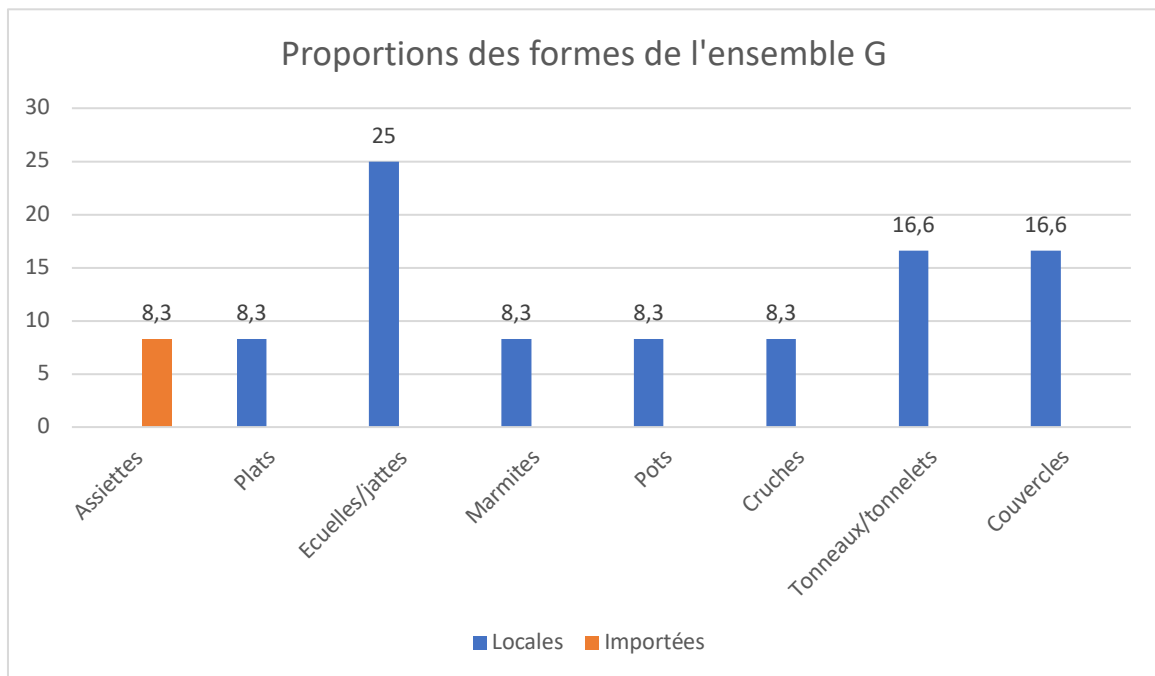
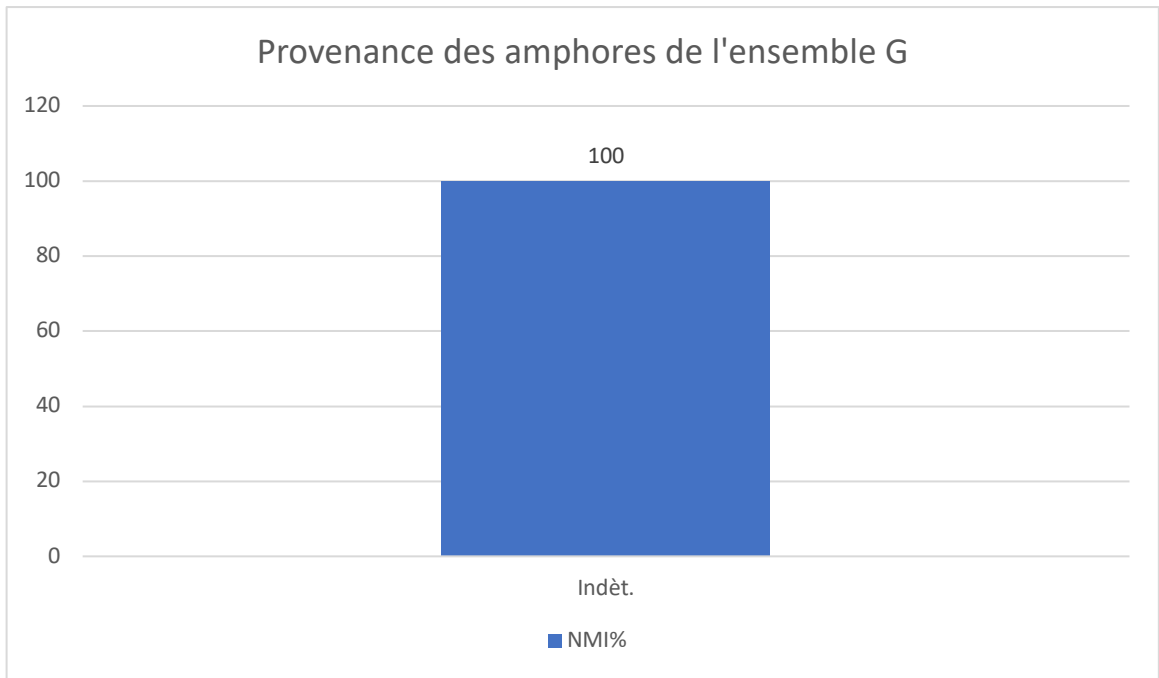


Fig. 6.4: Tableau des céramiques de l'ensemble G.

UF	NMI	Categorie	Forme	Type	Bord	Fond	Panse	Anse	Profil	NR	Décor	Commentaire	Inventaire	Illustration
2843	1	TSIT	Indét.			1				1				
2772		TSIT	Assiette	Indét.			1			1				
2843	1	PARFIN A	indèt.				1			1				
2843	1	CP A	Indét.				2			2				
3146	1	CP B	Pot	Paunier 2			1			1				
3146		CP B	Pot	Paunier 2	1					1			VB19.3146.02	Pl. 1.1
3146	1	TSI	Indét.		1					1				
2843		TSI	Indét.			1				1				
3146	1	EIR	Plat	indèt.		1				1				
2883		EIR	Plat	indèt.			2			2				
2848	1	PCCRU	Cruche	LS CRU Cr.2.6.a	1					1			VB18.2848.01	Pl. 1.1
852		PCCRU	Cruche	indèt.			1			1				
2848		PCCRU	Cruche	indèt.			3			3				
3146		PCCRU	Cruche	indèt.			4			4				
2843		PCCRU	Cruche	Indét.		1	14			15				
2883		PCCRU	Cruche	indèt.			3			3				
2772		PCCRU	Cruche	Indét.			1			1				
3146	3	PC	Ecuelle/Jatte	LS PC E.2.3.b		1	2			3				
3146		PC	Ecuelle/Jatte	LS PC E.2.3.b	1					1			VB19.3146.03	Pl. 1.1
2772		PC	Ecuelle/Jatte	LS PC E.2.3.b	1					1				
2848		PC	Indét.				2			2				
3146		PC	Indét.				3			3				
2843		PC	Indét.				1			1		Jeton	VB18.2843.01	Pl. 1.1
2843		PC	Indét.				8			8				
2772		PC	Indét.				2			2				
2772		PC	Indét.				2			2				

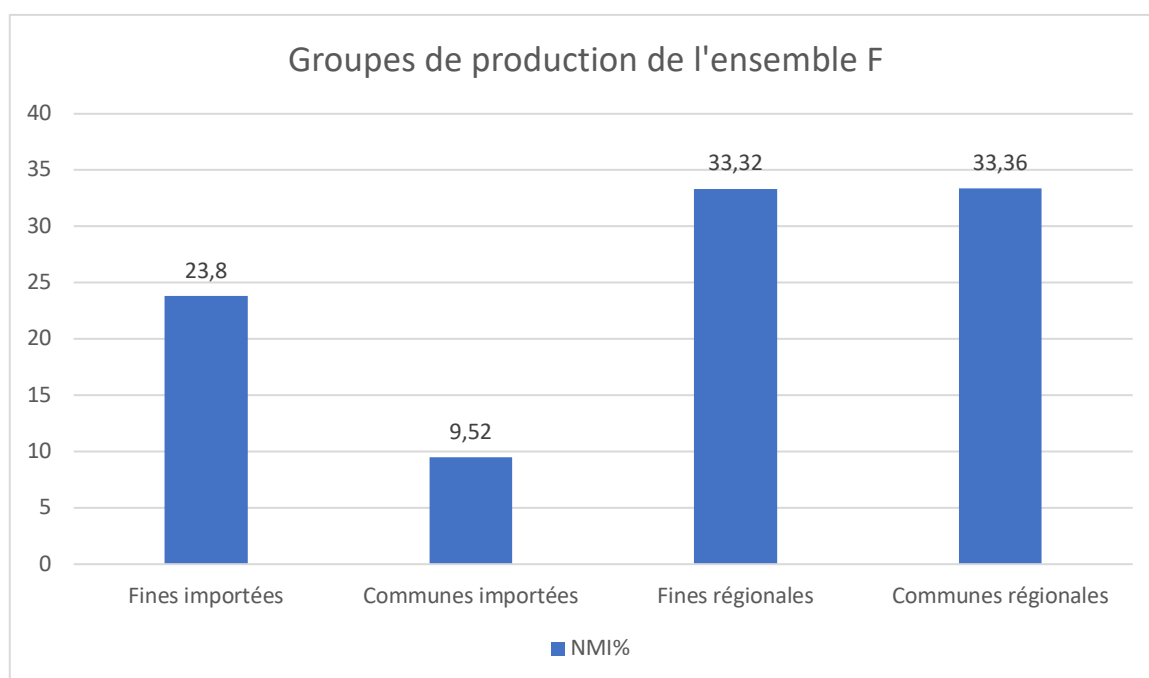
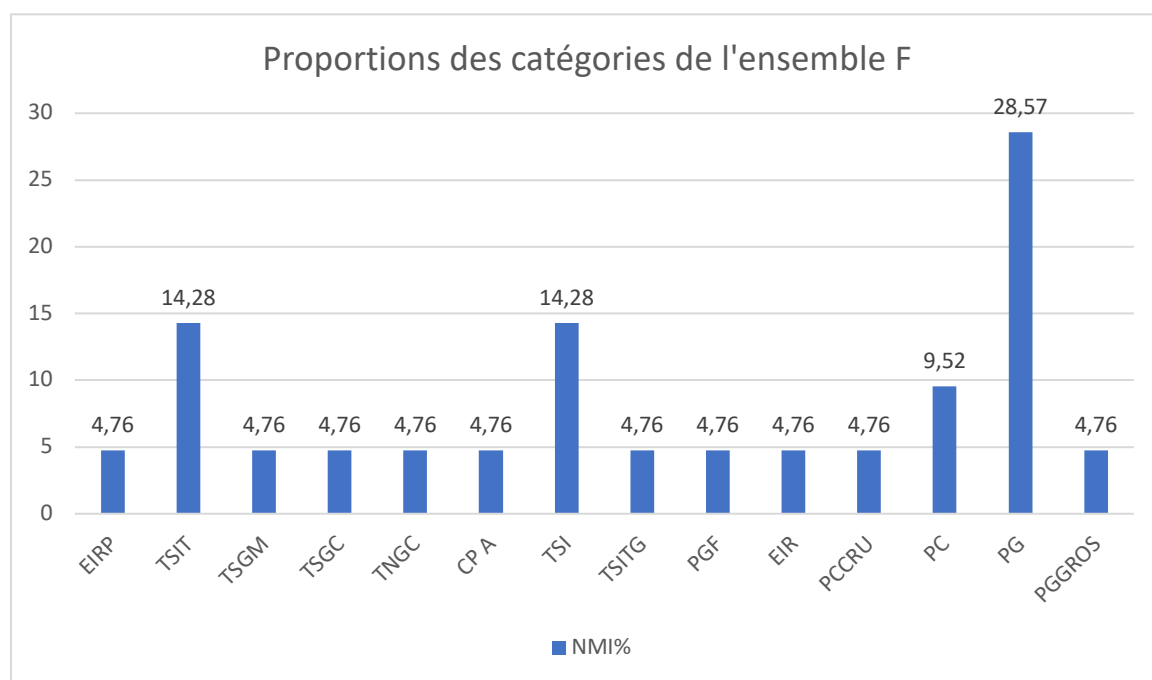
2843	5	PG	Marmite tripode	Indét.		1				1			
2843		PG	Tonneau/tonnelet	LS PG T.1.1.a	1					1			
2843		PG	Tonneau/tonnelet	LS PG T.1.1.a	1					1		VB18.2843.04	Pl. 1.1
3146		PG	Couvercle	LS PG Cv.3.2.a	1					1			
3146		PG	Couvercle	LS PG Cv.3.2.a	1					1		VB19.3146.04	Pl. 1.1
852		PG	Indét.				4			4			
852		PG	Indét.				1			1	Peigné		
2848		PG	Indét.				1			1	Peigné		
3146		PG	Indét.				3			3	Peigné		
3146		PG	Indét.		1		4			5			
2843		PG	Indét.				6			6	Peigné		
2843		PG	Indét.		2		10			13			
2843		PG	Indét.				1			1	Impressions rectangles		
2883		PG	Indét.		1					1			
2772		PG	Indét.			1	14			24			
TOTAUX	15				9	9	92			91			

Fig. 6.5: Tableau des amphores de l'ensemble G.

UF	NMI	Categorie	Forme	Type	Bord	Fond	Panse	Anse	Profil	NR	Décor	Commentaire	Inventaire	Illustration
2843	1	indét.			26	1				27				
TOTAUX	1				26	1				27				

3.2.2. Ensemble F - Période F (15-30/40 ap. J.-C.) (Pl. 2.1-2.2)

Fig. 7.1: Proportions choisies de l'ensemble F (NMI exprimé en pourcents).



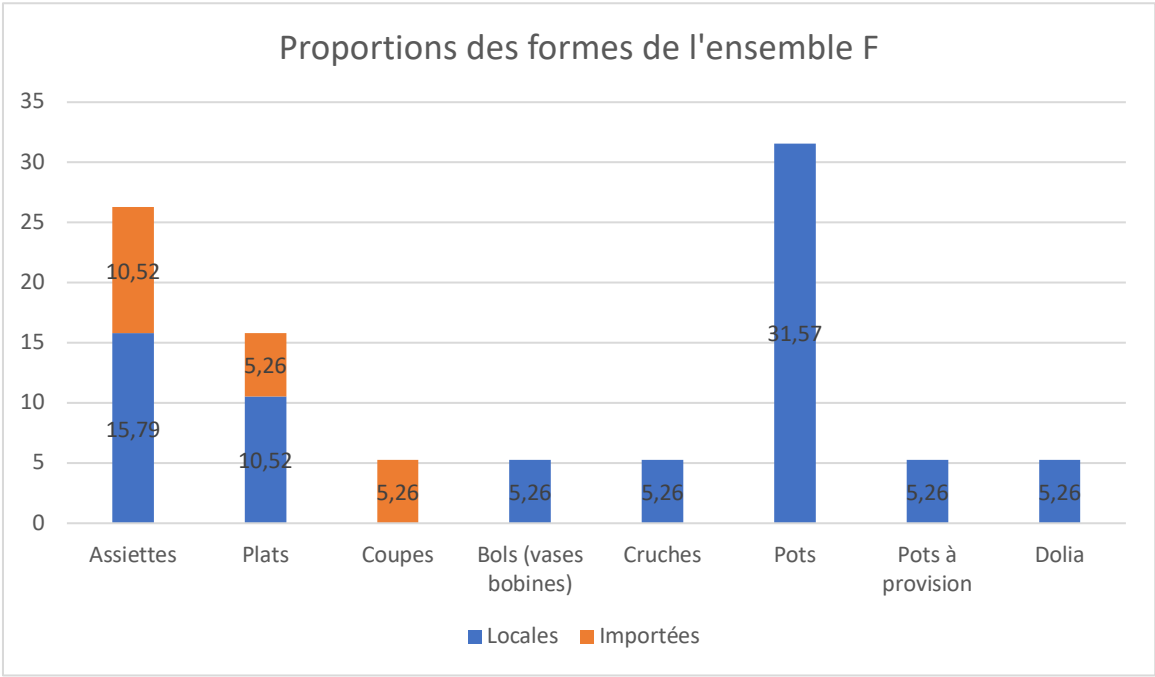


Fig. 7.2: Tableau des céramiques de l'ensemble F

UF	NMI	Categorie	Forme	Type	Bord	Fond	Panse	Anse	Profil	NR	Décor	Commentaire	Inventaire	Illustration
2767	3	TSIT	Assiette	Ha. 2			1			1				
2767		TSIT	Coupe	Ha. 8			2			2				
2767		TSIT	Assiette	indét.		1				1				
2767		TSIT	Plat	indét.		1				1				
2767		TSIT	Indét.				3			3				
2767	1	TSGM	Assiette	Ha. 2 / Drag. 17a			1			1				
2683	1	TSGC	Indét.				1			1				
2683	1	TNGC	Indét.				1			1				
2683	1	EIRP	Plat	AV 272	1					1			VB19.2683.02	Pl. 2.1, n°1
2683	1	CP A	Indét.				1			1				
2767	3	TSI	Assiette	imit. Ha. 1b, L1a	1					1			VB18.2767.08	Pl. 2.1, n°2
2767		TSI	Assiette	imit. Ha. 2 / Drag. 17a, L2	1					1			VB18.2767.09	Pl. 2.1, n°3
2683		TSI	Assiette	imit. Drag. 15/17, L7a	1					1			VB19.2683.05	Pl. 2.1, n°4
2683		TSI	Indét.				1			1				
2767		TSI	Indét.				12			12				
2767	1	TSITG	Indét.			1				1				
2767	1	PGF	Bol	LS PG B.3.1 (vase bobine)	1					2			VB18.2767.04	Pl. 2.1, n°5
2767		PGF	Indét.				1			1				
2683	1	EIR	Plat	LS EIR A.2.5	1					1			VB19.2683.03	Pl. 2.1, n°6
2767		EIR	Plat	Indét.		2				2				
2767	1	PCCRUCRUCHE	Cruche	LS CRU Cr.2.6.a	1					1			VB18.2767.05	Pl. 2.1, n°7
2683		PCCRUCRUCHE	Cruche	Indét.			9			9				
2767		PCCRUCRUCHE	Cruche	Indét.		1	13	1		15				
3184	2	PC	Pot	LS PC P.1.10.a	1					2			VB19.3184.02	Pl. 2.1, n°8
2683		PC	Pot à provi	LS PC P.1.10.c	1					1			VB19.2683.06	Pl. 2.1, n°9
3184		PC	Pot	Indét.		1				1				
2683		PC	Indét.				3	1		6				
3184		PC	Indét.				8			8				
2767		PC	Indét.				4			4				
2767		PC	Indét.				1			1	Guilloché			
2767	6	PG	Pot	LS PG P.1.2.a	1					1	Peigné		VB18.2767.07	Pl. 2.2, n°10
2683		PG	Pot	LS PG P.1.3.a	1					1			VB19.2683.04	Pl. 2.2, n°11
2767		PG	Pot	LS PG P.3.2	1					1				
2767		PG	Pot	LS PG P.3.2	1					1			VB18.2767.10	Pl. 2.2, n°12
2767		PG	Pot	LS PG P.3.7.b	1					1			VB18.2767.11	Pl. 2.2, n°13
2767		PG	Dolium	LS PG D.1.1.b	1					1			VB18.2767.06	Pl. 2.2, n°14
2683		PG	Dolium	Indét.			1			1				
2683		PG	Indét.			1	3			4				
3184		PG	Indét.			1	3			4				
2767		PG	Indét.			2	16			18				
2767		PG	Indét.				1			1	Peigné			
2767		PG	Indét.				46			1	Impressions digitées			
2767		PG	Indét.				1			1	Guilloché			
2683	1	PGGROS	Jeton				1			1			VB19.2683.01	
TOTAUX	24				15	11	86	2		121				

Ensemble E-1 – Période E-1 (50 ap. J.-C.) (Pl. 3.1-3.2

Fig. 8.1: Parcelle 2, période E-1.

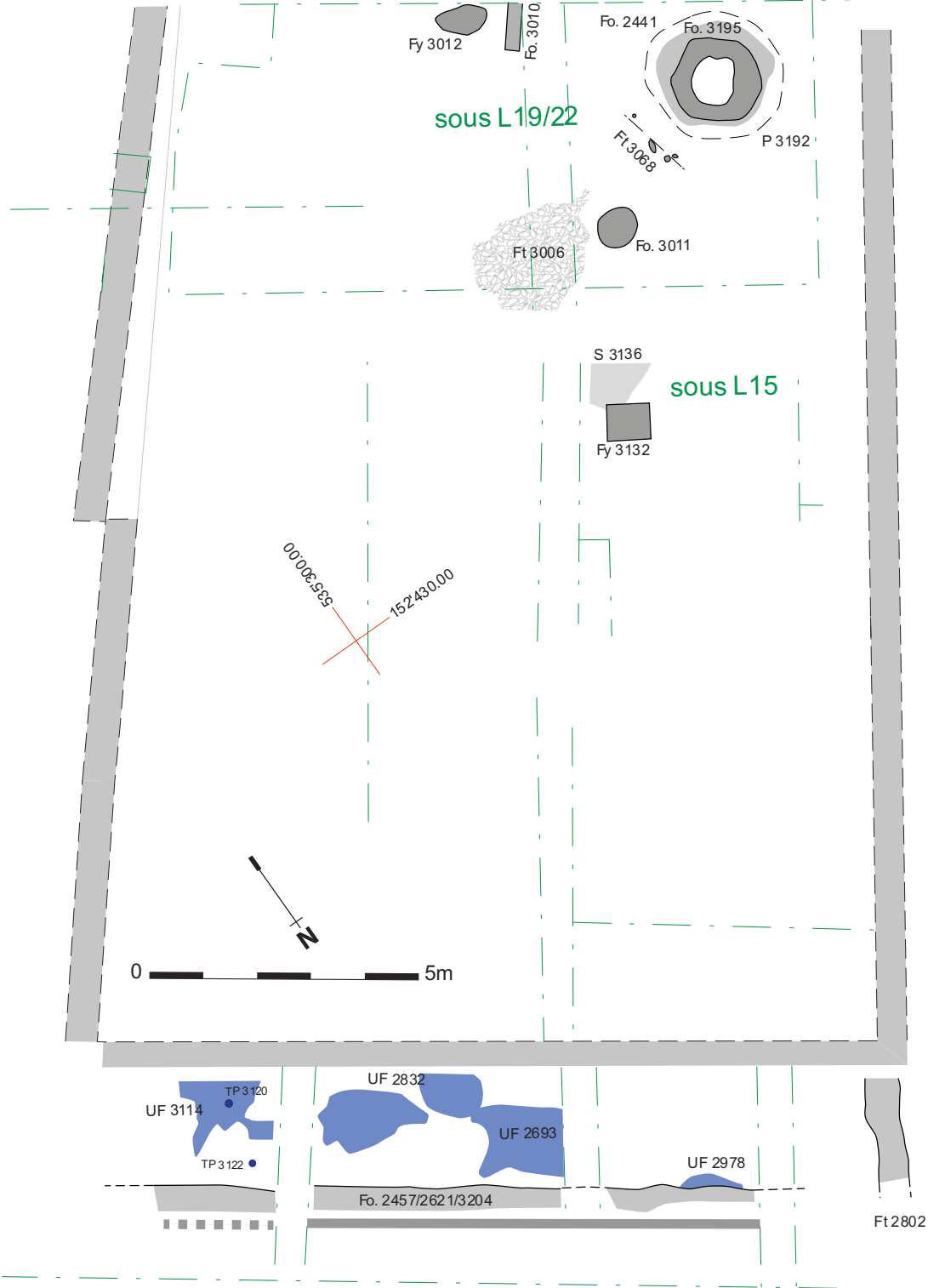


Fig. 8.2: Coupe de référence nord-sud du portique de la parcelle 2.



1. [3119] remblais et niveau de sol de la période E/F état 1, fonctionnant avec le solin est-ouest M [3200]
2. [3118] niveau d'installation du niveau de circulation S [2832] de la période E état 1
3. [2989] remblai d'aménagement du niveau de circulation S [2832] ; présence de deux structures est-ouest remplies du même matériau
4. Fo. [3204] fossé de bord de voie antérieur au fossé Fo. [1204] de la période E état 2
- 5a. [2981] niveaux de voie initiaux ?
- 5b. [2694] recharges successives de lavoie
6. [2832] sol aménagé ou démolition de la période E état 1, avec lambeau d'occupation dans la partie nord.

7. [2833] [2985] feuilletage d'occupation avec recharges successives de la période E état 2
8. [2110] feuilletage d'occupations successives de la période E état 2
9. [1559a] feuilletage d'occupations successives de la période D état 1
10. [1559b] recharges sur les niveaux précédents et aménagement du niveau suivant avec une dernière occupation de la période D état 1 visible dans la partie nord
11. [1554a] couche d'occupation sur un niveau de circulation de la période D état 1 se trouvant à sa base
12. [1554b] remblai d'aménagement du sol du toit fonctionnant avec le Ft [1227] de la période D état 2
13. [1438a] feuilletage d'occupation de la période D2
14. [1438b] recharge de remblai dans les couches [1438] au sud contre le fossé Fo. [1204]
15. Fo. [1204] fossé bordant la voie au nord ; périodes D, états 1 et 2 remplissage UF [2453]
16. [1395] [958] remblai de la période C1
17. [...] tranchée de fondation du mur M [35] de la période C
18. [947] niveaux de travail et d'égalisation et de circulation de la période C1
19. [957] recharges du niveau de circulation du portique et démolition générale de la période C1

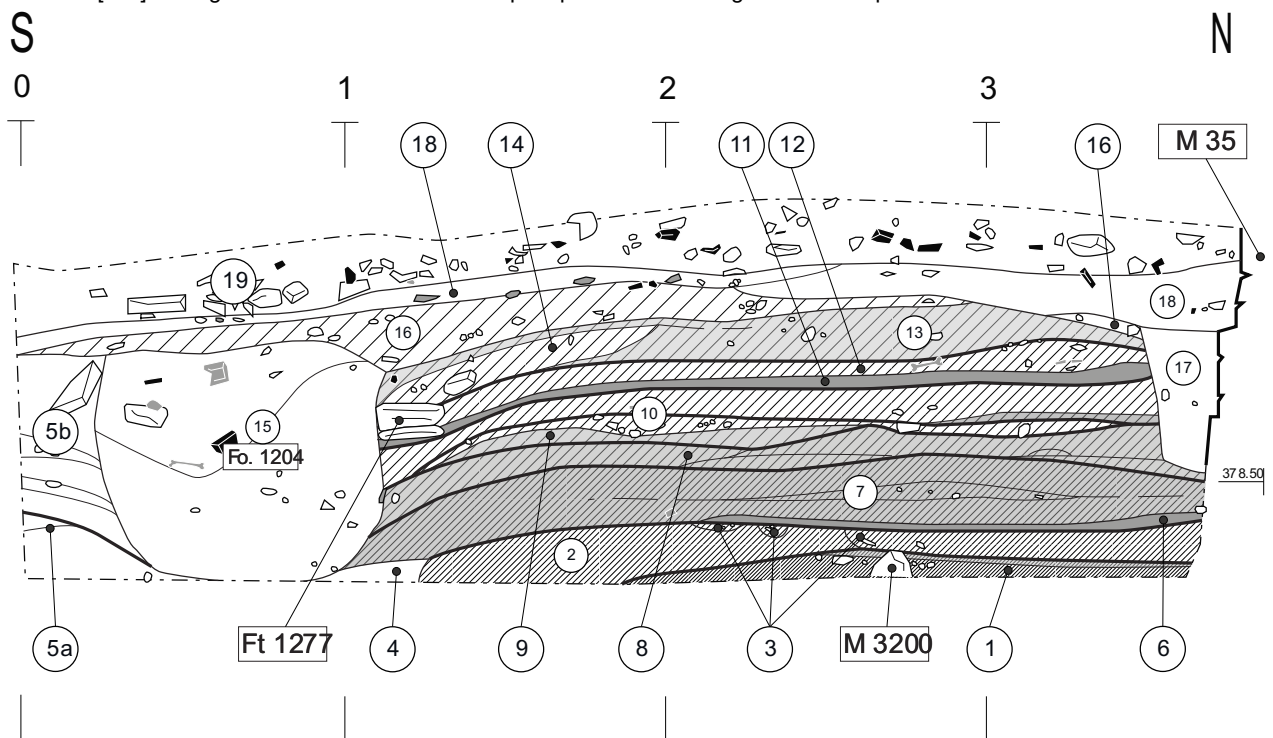
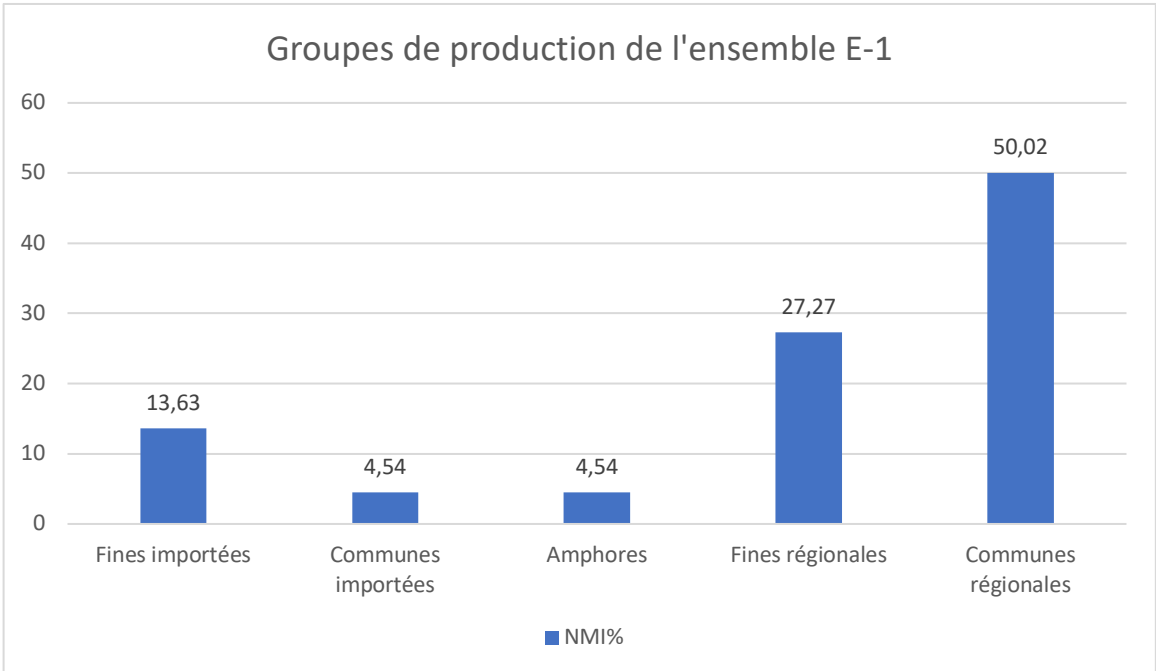
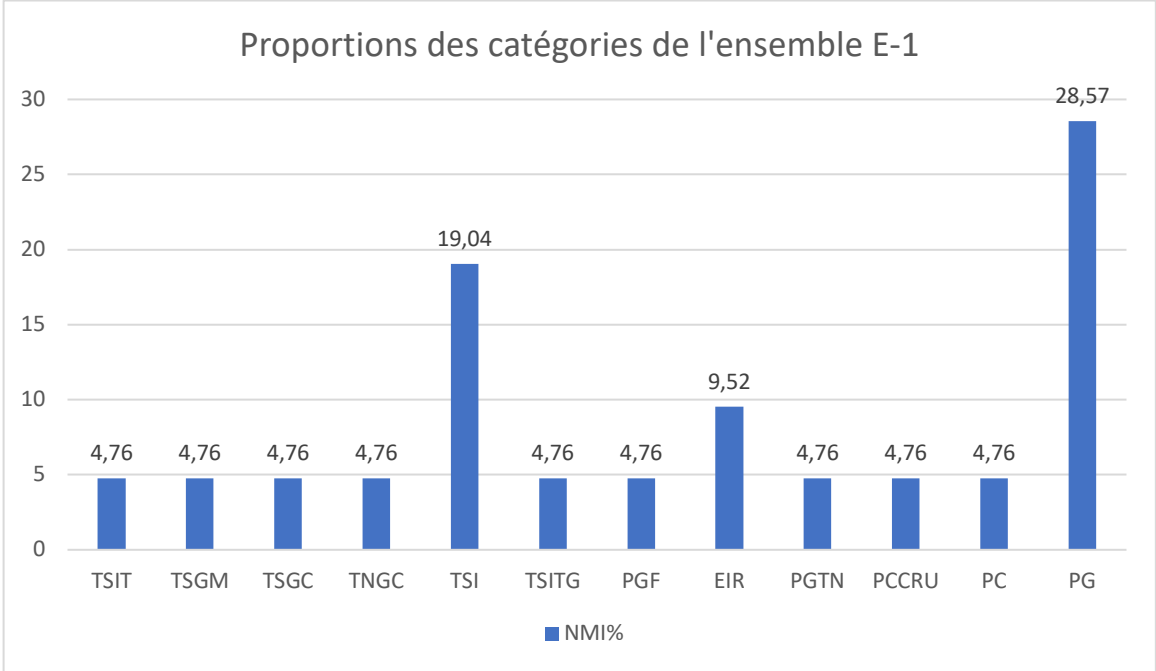


Fig. 8.3: Proportions choisies de l'ensemble E-1 (NMI exprimé en pourcents).



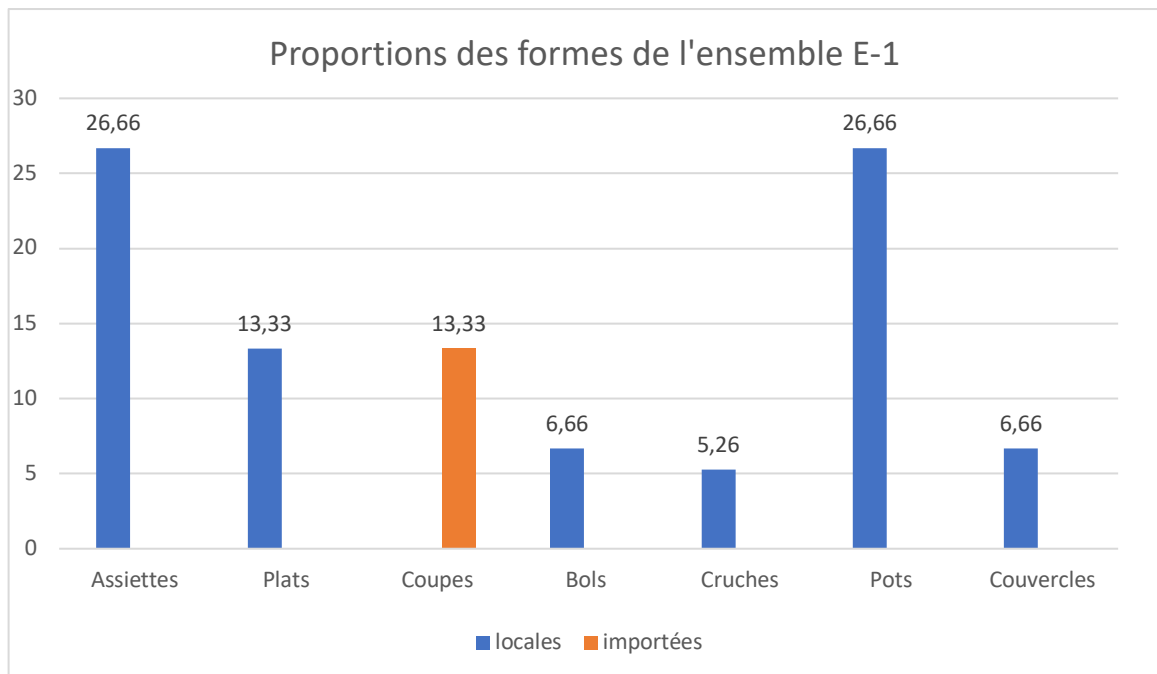
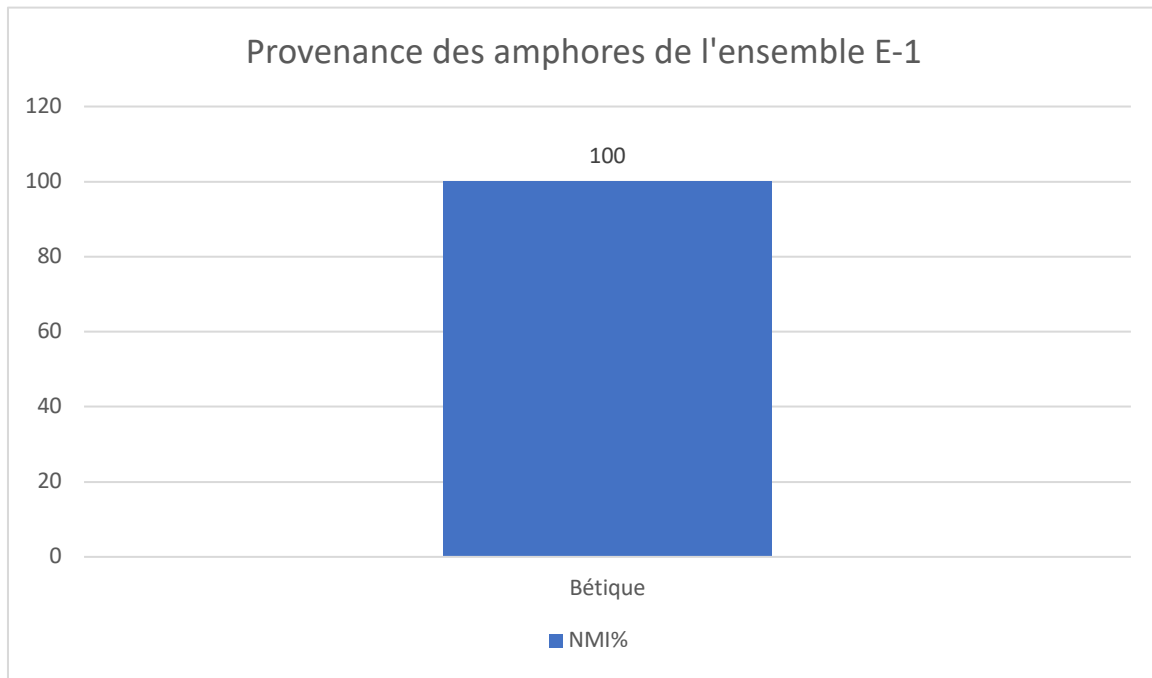


Fig. 8.4: Tableau des céramiques de l'ensemble E-1.

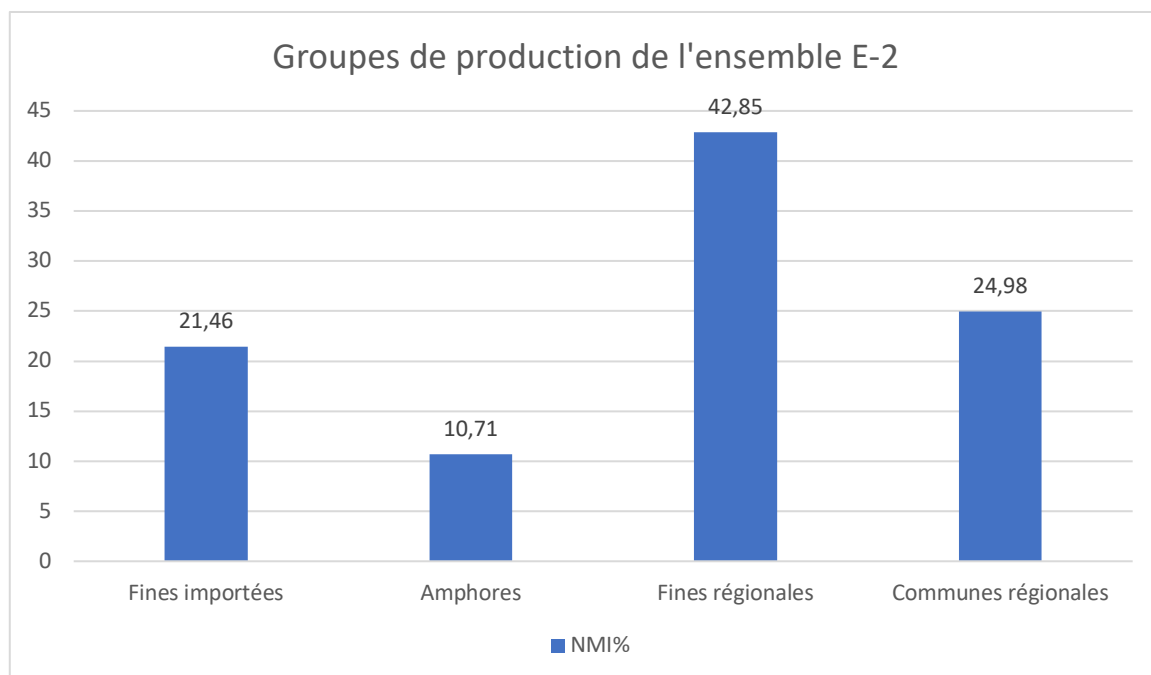
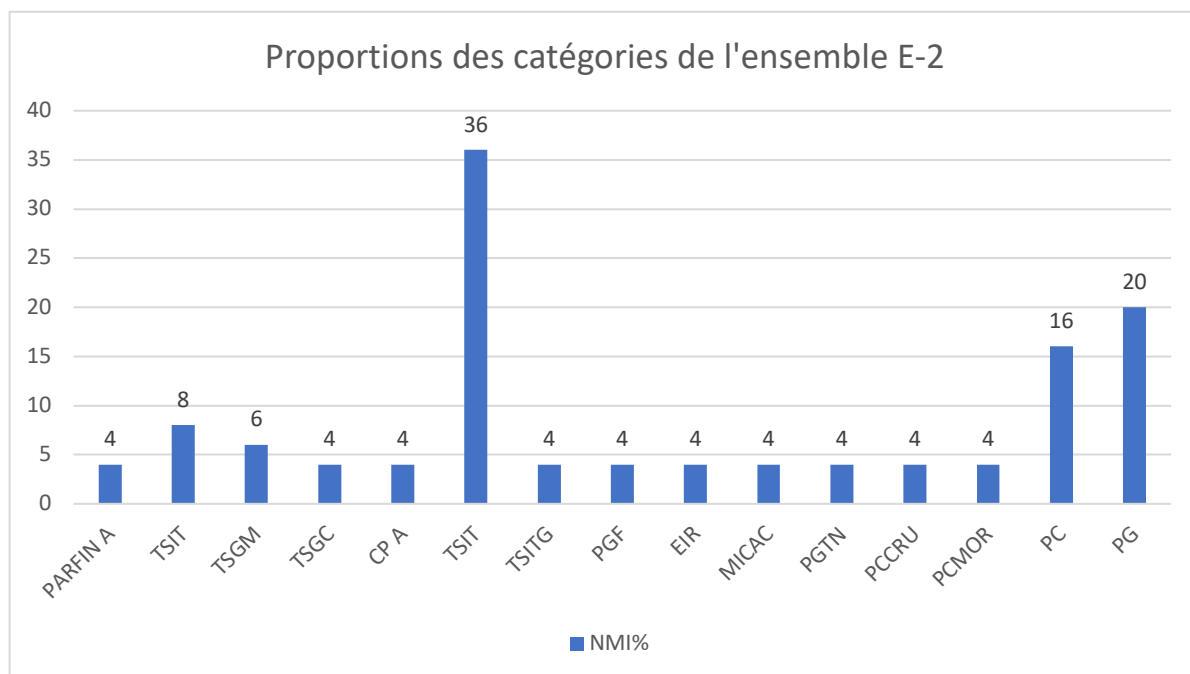
UF	NMI	Categorie	Forme	Type	Bord	Fond	Panse	Anse	Profil	NR	Décor	Commentaire	Inscription	Inventaire	Illustration
2981	1	TSIT	Coupe	indét.		1				1			estampille: XANTI	VB19.2981.01	Pl. 3.1, n°1
2981	1	TSGM	Indét.				1			1					
2981	1	TSGC	Coupe	Drag. 4/22	1					1		diam. 9cm		VB19.2981.05	Pl. 3.1, n°2
2981	1	TNGC	Indét.				1			1		Pâte kaolinithique			
2981	4	TSI	Assiette	imit. Ha. 2 / Drag. 17a, L2	1					1				VB19.2981.03	Pl. 3.1, n°3
2981		TSI	Assiette	imit. Ha. 2 / Drag. 17a, L2	2					2					
2981		TSI	Assiette	Drack 4, L4	1					2					
2981		TSI	Indét.				15			15					
2981	1	TSITG	Indét.				1			1					
2981	1	PGF	Indét.				8			8					
2981	2	EIR	Plat	LS EIR A.1.1.a					1	1				VB19.2981.06	Pl. 3.1, n°4
2981		EIR	Plat	LS EIR A.2.9 var.	1					1					
2981		EIR	Indét.				1			1					
2981	1	PGTN	Indét.				3			3					
2981	1	PCCRU	Cruche	LS CRU Cr.1.2	1					1				VB19.2981.10	Pl. 3.1, n°5
2981		PCCRU	Cruche	Indét.		3	10			13					
2981	1	PC	Indét.				12			12					
2981	6	PG	Bol	LS PG B.5.1	1					1					
2981		PG	Pot	LS PG P.1.1.a	1					1					
2981		PG	Pot	LS PG P.1.1.b	1					1				VB19.2981.09	Pl. 3.1, n°6
2981		PG	Pot	LS PG P.1.3.a	1					1				VB19.2981.08	Pl. 3.2, n°7
2981		PG	Pot	LS PG P.3.5	1					1				VB19.2981.04	Pl. 3.2, n°8
2981		PG	Couvercle	LS PG Cv.2.1	1					1				VB19.2981.07	Pl. 3.2, n°9
2981		PG	Pot	Indét.	3					3					
2981		PG	Indét.				1			1	Peigné				
2981		PG	Indét.			1	20			21					
TOTAUX	21				16	5	73			96					

Fig. 8.5: Tableau des amphores de l'ensemble E-1.

UF	NMI	Categorie	Type	Bord	Fond	Panse	Anse	Profil	NR	Décor	Commentaire	Inscription	Inventaire
2981	1	Bétique	Dressel 20			9			9				

3.2.4. Ensemble E-2 - Période E-2 (50-80/90 (?) ap. J.-C.) (Pl. 4.1)

Fig. 9.1: Proportions choisies de l'ensemble E-2 (NMI exprimé en pourcents).



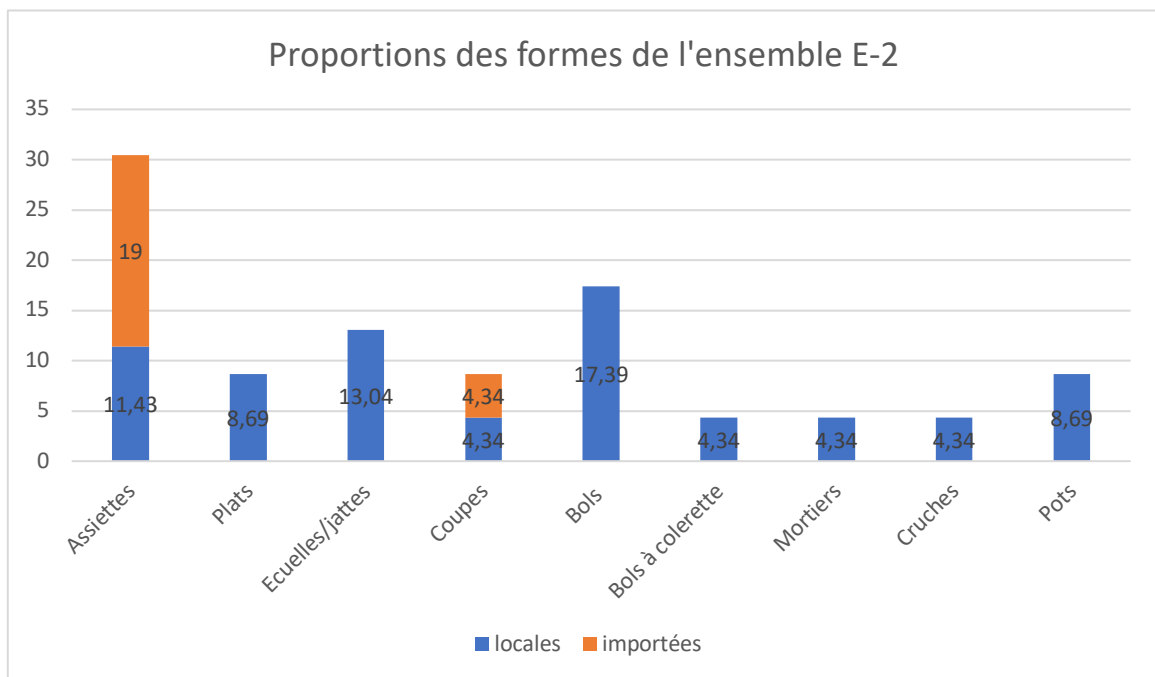
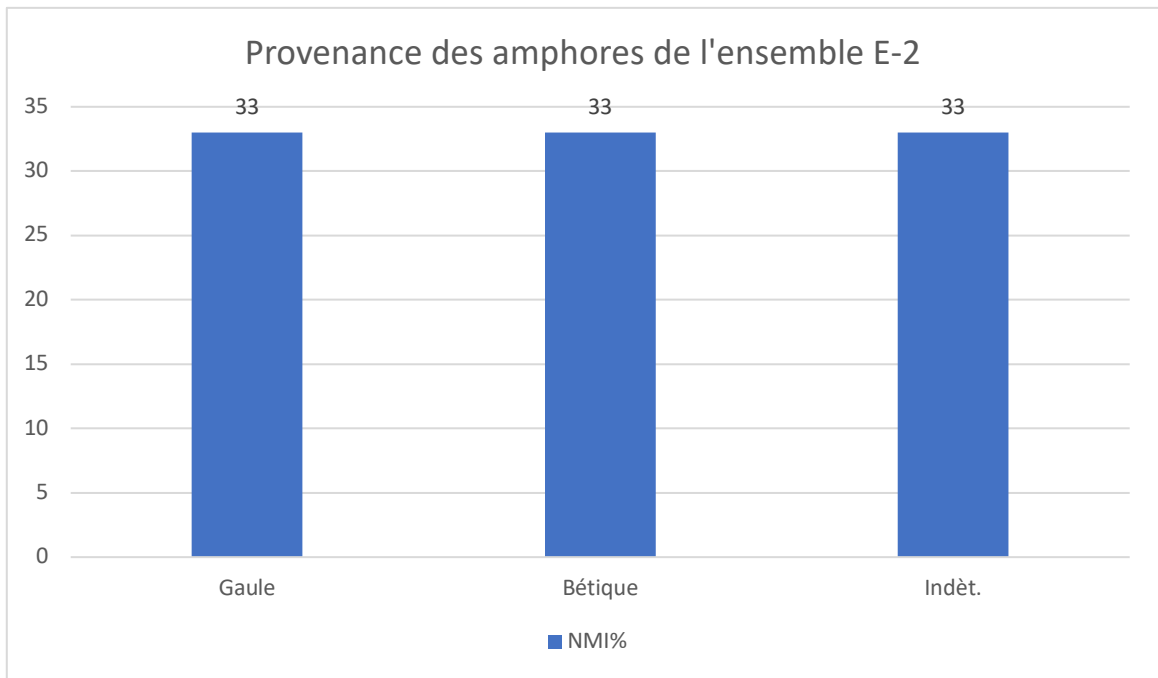
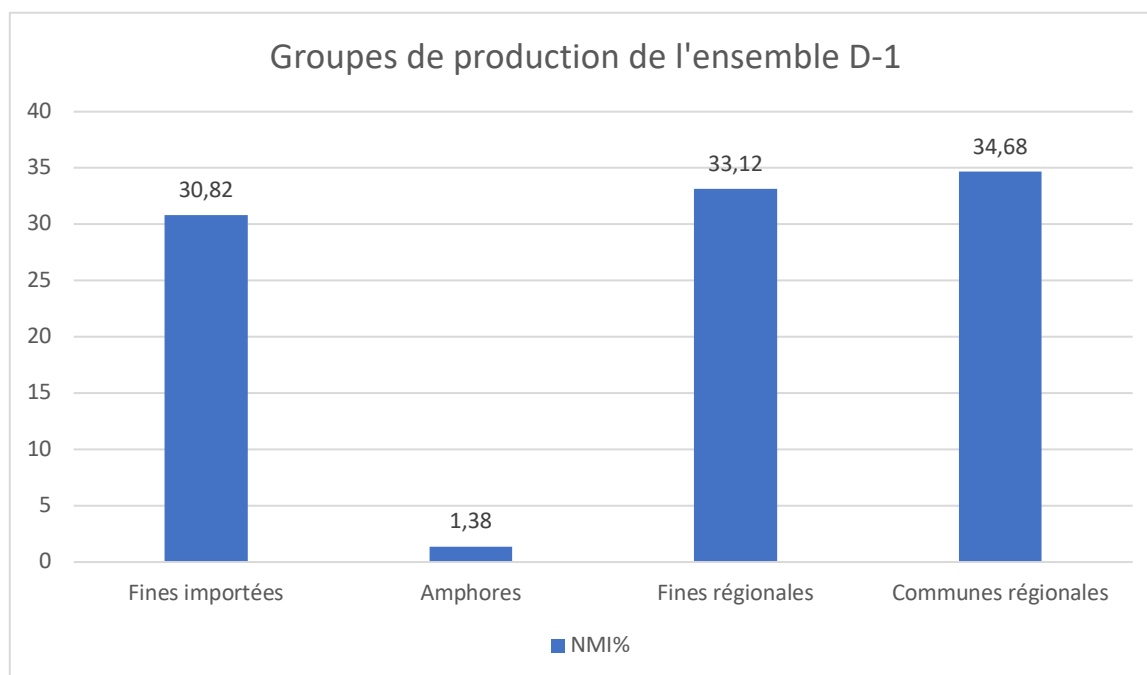
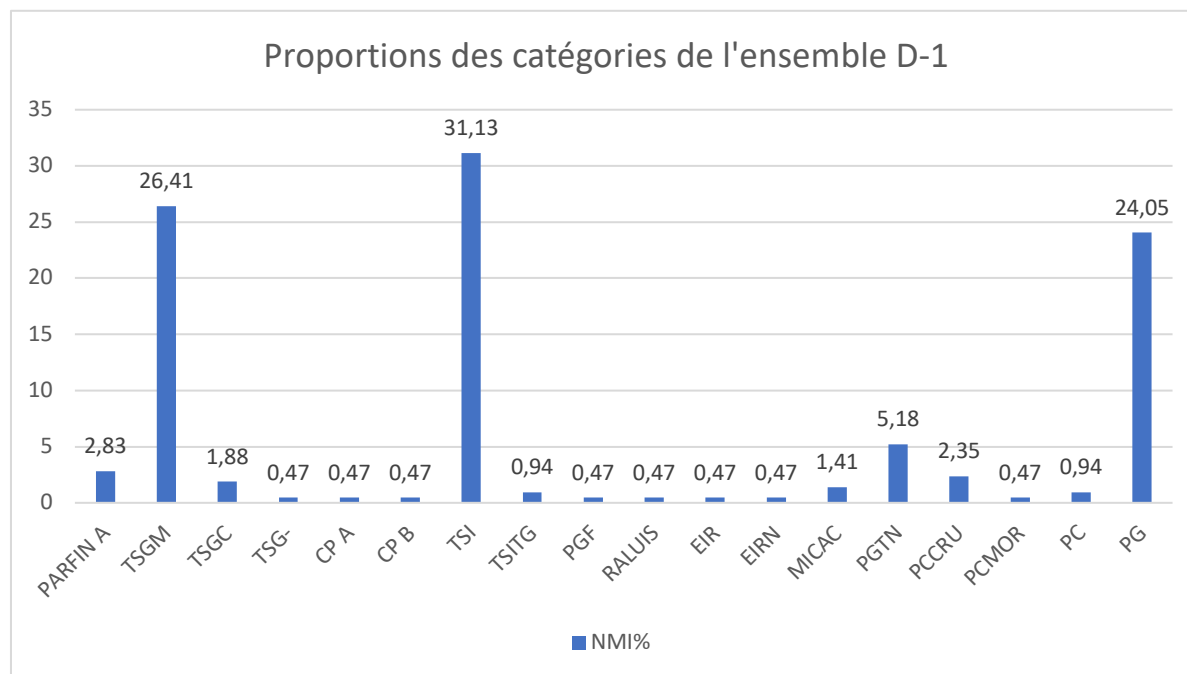


Fig. 9.2: Tableau des céramiques de l'ensemble E-2.

UF	NMI	Categorie	Forme	Type	Bord	Fond	Panse	Anse	Profil	NR	Décor	Commentaire	Inventaire	Illustration
2458	1	PARFIN A	Indét.				1			1				
2451	2	TSIT	Assiette	Ha. 2	1					1			VB18.2451.08	Pl. 4.1,n°1
2451		TSIT	Assiette	Ha. 2	1					1				
2451		TSIT	Indét.				1			1				
2991	2	TSGM	Assiette	indét.		1				1				
2451		TSGM	Coupe	Drag. 27C	1					1			VB18.2451.07	Pl. 4.1,n°2
2451		TSGM	Indét.		2		5			9				
2458	1	TSGC	Coupe	Indét.		1				1				
2451		TSGC	Indét.					2		2				
2458	1	CP A	Bol	Paunier 11	1					1			VB19.2458.07	Pl. 4.1,n°3
2458		CP A	Bol	indét.	1					1				
2458		CP A	Indét.					1		1				
2451	9	TSI	Assiette	imit. Ha. 2 / Drag. 17	1					1			VB18.2451.11	Pl. 4.1,n°4
2458		TSI	Assiette	imit. Ha. 2 / Drag. 17	1					1				
2991		TSI	Assiette	imit. Ha. 2 / Drag. 17	1					1				
2991		TSI	Assiette	imit. Ha. 5	1					1			VB19.2991.01	Pl. 4.1,n°6
2458		TSI	Ecuelle/Jatte	L18	1					1			VB19.2458.06	Pl. 4.1,n°7
2451		TSI	Bol	Drack 21, L40b	1					1			VB18.2451.10	Pl. 4.1,n°9
2451		TSI	Bol	Drack 21, L40c	1					1			VB18.2451.09	Pl. 4.1,n°8
2458		TSI	Bol	Drack 21			1			1				
2458		TSI	Bol à colerette	imit. Ritt. 12, L49	1		1			2		dont 1 colerette et un bord avec colerette découpée		
2991		TSI	Bol	L50b	1					1				
2458		TSI	Assiette	Indét.				1		1				
2451		TSI	Indét.		1	5	24			30				
2458		TSI	Indét.		1	4	19			24				
2991		TSI	Indét.			1	2			3				
2458	1	TSITG	Assiette	imit. Drag. 15/17, L7	1					1			VB19.2458.08	Pl. 4.1,n°5
2451		TSITG	Indét.					5		5				
2451	1	PGF	Indét.					1		1				
2458		PGF	Indét.					10		10				
2458	1	EIR	Plat	LS EIR A.1.1.b	1					1			VB19.2458.05	Pl. 4.1,n°10
2451		EIR	Plat	indét.		1				1				
2458		EIR	Plat	Indét.		1		1		2				
2451	1	MICAC	Indét.					1		1				
2458	1	PGTN	Pot	LS PG P.3.1	1					1			VB19.2458.09	Pl. 4.1,n°11
2451		PGTN	Indét.					1		1				
2458		PGTN	Indét.					1		1	Godrons			

3.2.5. Ensemble D-1 – Période D-1 (100/150 ap. J.-C.) (Pl. 5.1-5.6)

Fig. 10.1: Proportions choisies de l'ensemble D-1 (NMI exprimé en pourcents).



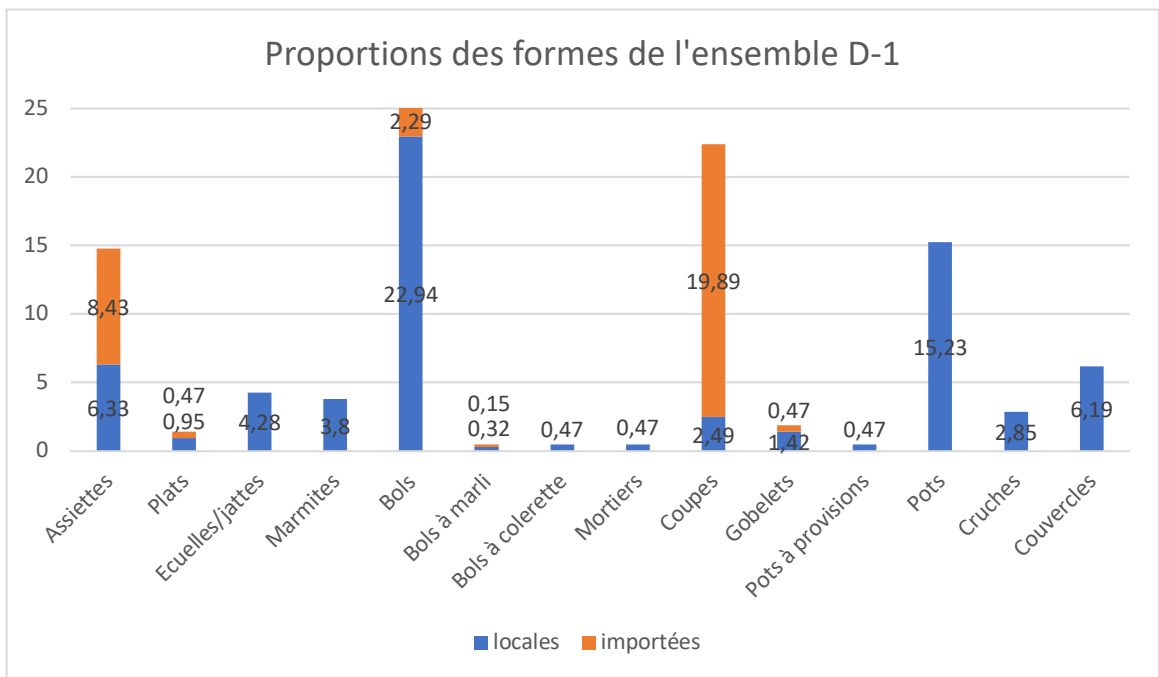
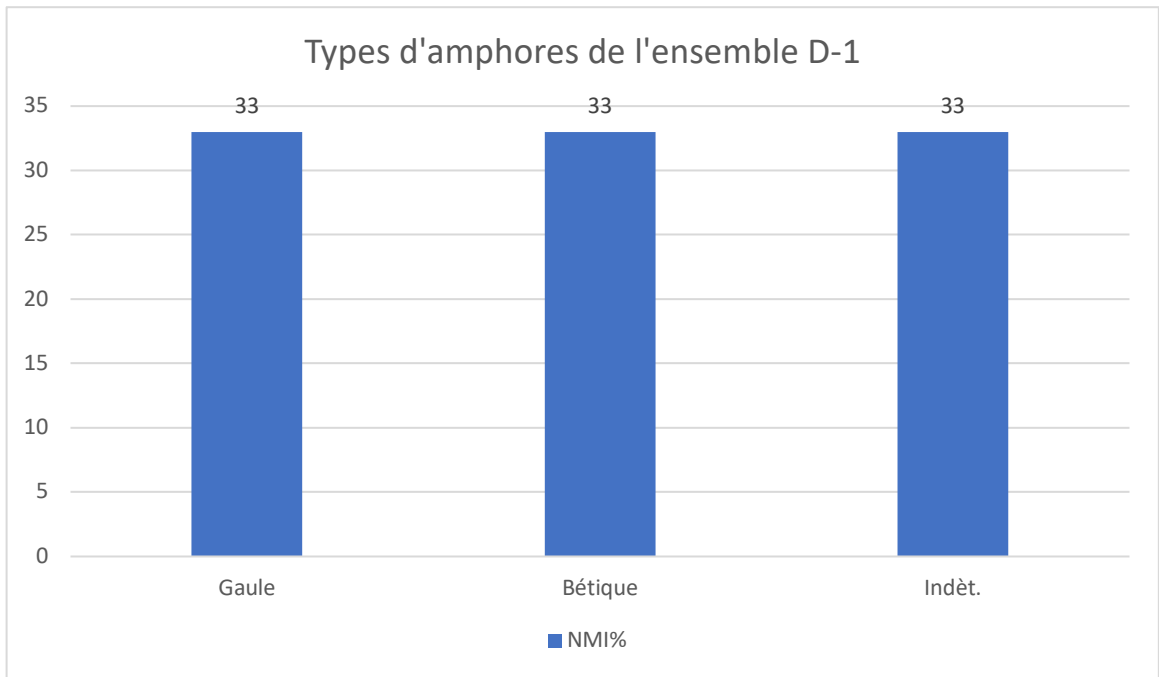


Fig. 10.2: Tableau des céramiques de l'ensemble D-1.

UF	NMI	Categorie	Forme	Type	Bord	Fond	Panse	Anse	Profil	NR	Décor	Commentaire	Inscription	Inventaire	Illustration
2910	6	PARFIN A	Coupe	Bertrand 2.2	1		4			13	Sablé			VB19.2910.86	Pl. 5.2, n°18
2910		PARFIN A	Coupe	Bertrand 4.1.1	1					2	Sablé				
2910		PARFIN A	Coupe	Bertrand 4.1.1	1					1	Écailles à la barbotine, sablage interne			VB19.2910.87	Pl. 5.2, n°19
2910		PARFIN A	Coupe	Bertrand 4.1/2	1					1					
2910		PARFIN A	Coupe	Bertrand 5.1	1					1					
2910		PARFIN A	Gobelet	Bertrand 16.2.1	1					1					
2910		PARFIN A	Indét.					3		3	Sablé				
2910		PARFIN A	Indét.					2		2	pastille cloutées, sablage interne				
2910		PARFIN A	Indét.					6		6	Écailles à la barbotine				
2910		PARFIN A	Indét.					1		1					
2910	56	TSGM	Assiette	Drag. 16	1					1				VB19.2910.55	Pl. 5.1, n°1
2910		TSGM	Assiette	Ha.2 / Drag. 17	1					1				VB19.2910.98	Pl. 5.1, n°2
2910		TSGM	Assiette	Drag. 15/17A	3					3					
2910		TSGM	Assiette	Drag. 15/17	1					2				VB19.2910.88	Pl. 5.1, n°3
2910		TSGM	Assiette	Drag. 15/17A	1					1				VB19.2910.90	Pl. 5.1, n°4
2910		TSGM	Assiette	Drag. 15/17	6		3			9					
2910		TSGM	Assiette	Ha.2 / Drag. 17	3					3					
2910		TSGM	Assiette	Herm. 12C		1				1					
2910		TSGM	Assiette	Drag. 18B	1					1				VB19.2910.93	Pl. 5.1, n°5
2910		TSGM	Assiette	Curle 15	1					1					
2910		TSGM	Assiette	Curle 15	1					1				VB19.2910.94	Pl. 5.1, n°6
2910		TSGM	Coupe	Drag. 4/22	4	1				5					
2910		TSGM	Coupe	Drag. 24/25A	1					1	Relief d'applique			VB19.2910.95	Pl. 5.1, n°7
2910		TSGM	Coupe	Drag. 24/25	2					2					
2910		TSGM	Coupe	Drag. 27B					1	1		estampille: RON ?		VB19.2910.28	Pl. 5.1, n°8
2910		TSGM	Coupe	Drag. 27C	2					2					
2910		TSGM	Coupe	Drag. 27C	1					1				VB19.2910.97	Pl. 5.1, n°9
2910		TSGM	Coupe	Drag. 27	13					14					
2910		TSGM	Coupe	Drag. 27	1					1				VB19.2910.99	Pl. 5.1, n°10
2910		TSGM	Coupe	Drag. 27	1					1				VB19.2910.100	Pl. 5.1, n°11
2910		TSGM	Coupe	Drag. 4/22					1	1		diam. 12cm		VB19.2910.89	Pl. 5.2, n°13
2910		TSGM	Coupe	Ritt. 9	1					1				VB19.2910.96	Pl. 5.2, n°14
2910		TSGM	Coupe	Drag. 35	1					1					
2910		TSGM	Coupe	Ritt. 8	1					1				VB19.2910.61	Pl. 5.2, n°15
2910		TSGM	Coupe	Ritt. 9	1	1	1			3					
2910		TSGM	Bol	Drag. 29B	1					5					
2910		TSGM	Bol	Drag. 29	2		7			12					
2910		TSGM	Bol	Drag. 29	1					2				VB19.2910.91	Pl. 5.2, n°16
2910		TSGM	Bol à colerette	Ritt. 12			3			3					
2910		TSGM	Bol à colerette	Ritt. 12	1					1				VB19.2910.92	Pl. 5.2, n°17
2910		TSGM	Assiette	Indét.		1				1					
2910		TSGM	Plat	Indét.		1				1					
2910		TSGM	Indét.		3	4	57			64					
2320		TSGM	Indét.				2			2					
2910	4	TSGC	Coupe	Drag. 27	3					3					
2910		TSGC	Coupe	Drag. 27	1					1				VB19.2910.101	Pl. 5.1, n°12
2910		TSGC	Coupe	Indét.		1				1					
2910	1	TSG-	Bol	Drag. 37?			1			1					
2910		TSG-	Indét.		1					1					
2910	1	CP A	Bol	Paunier 11	1					1				VB19.2910.131	Pl. 5.2, n°20
2910		CP A	Indét.				1			1	Echelles				
2910		CP A	Indét.				40			41					
2320	1	CP B	Indét.				1			1					
2910	66	TSI	Assiette	Drack 4, L4a	1					1				VB19.2910.112	Pl. 5.2, n°21

2910	66	TSI	Assiette	Drack 4, L4a	1				1				VB19.2910.112	Pl. 5.2, n°21
2910		TSI	Assiette	Drack 4, L4b			1		1					
2910		TSI	Assiette	Drack 4, L4	1				1					
2910		TSI	Assiette	Drack 4, L4	1				1				VB19.2910.104	Pl. 5.2, n°22
2910		TSI	Assiette	Drack 4, L4	1				1				VB19.2910.110	Pl. 5.3, n°23
2910		TSI	Assiette	imit. Drag. 18, L6	1				2			Péniche		
2910		TSI	Assiette	imit. Drag. 18, L6	1				1			Péniche	VB19.2910.106	Pl. 5.3, n°24
2910		TSI	Assiette	imit. Drag. 15/17, L7b	1				1				VB19.2910.54	Pl. 5.3, n°25
2910		TSI	Assiette	imit. Drag. 15/17, L7	1				1				VB19.2910.109	Pl. 5.3, n°26
2910		TSI	Assiette	imit. Drag. 15/17, L7	2		4		6					
2910		TSI	Assiette	imit. Drag. 4/22, L9		1			1					
2910		TSI	Assiette	imit. Drag. 36, L11	1				1				VB19.2910.111	Pl. 5.3, n°27
2910		TSI	Coupe	imit. Ha. 8/ Hof. 5, L23	1				3				VB19.2910.56	Pl. 5.3, n°28
2910		TSI	Coupe	imit. Drag. 24/25, L29a			1		2					
2910		TSI	Coupe	imit. Drag. 24/25, L29a	1				1				VB19.2910.105	Pl. 5.3, n°29
2910		TSI	Coupe	imit. Drag. 24/25, L29			1		3					
2910		TSI	Coupe	imit. Drag. 27, L30	1		1		2					
2910		TSI	Bol	Drack 21, L40c	1				1				VB19.2910.29	Pl. 5.3, n°30
2910		TSI	Bol	Drack 21, L40c	27		1		29					
2910		TSI	Bol	Drack 21, L40c	1				1			Graffito: [---] +X	VB19.2910.84	Pl. 5.3, n°31
2910		TSI	Bol	Drack 21, L40c	1				1				VB19.2910.113	Pl. 5.3, n°32
2910		TSI	Bol	Drack 21, L40c	1				1				VB19.2910.114	Pl. 5.3, n°33
2910		TSI	Bol	Drack 21, L40c	1				1				VB19.2910.115	Pl. 5.3, n°34
2910		TSI	Bol	Drack 21, L40c	1				1				VB19.2910.116	Pl. 5.3, n°35
2910		TSI	Bol	Drack 21, L40c	1				1				VB19.2910.117	Pl. 5.3, n°36
2910		TSI	Bol	Drack 21, L40c	1				1				VB19.2910.103	
2910		TSI	Bol	Drack 21, L40d	5				5					
2910		TSI	Bol	Drack 21, L40d	1				1				VB19.2910.53	Pl. 5.4, n°37
2910		TSI	Bol	Drack 21, L40d	1				1				VB19.2910.102	Pl. 5.4, n°38
2910		TSI	Bol	Drack 21	2		12		14					
2910		TSI	Bol	L47	1				1				VB19.2910.107	Pl. 5.4, n°39
2910		TSI	Bol	L50a	1				1				VB19.2910.108	Pl. 5.4, n°40
2910		TSI	Bol à colerette	imit. Ritt. 12, L49	2		17		21			dont 17 colerettes et 2 bords à colerettes découpées		
2910		TSI	Coupe	Indét.		1			1					
2910		TSI	Cruche	Indét.				1	1					
2910		TSI	Indét.		6		210		216					
2320		TSI	Indét.				3		3					
2910	2	TSITG	Coupe	imit. Ha. 8/ Hof. 5, L23	1				1					
2910		TSITG	Coupe	imit. Drag. 27, L30			1		1					
2910		TSITG	Indét.				12		12					
2910	1	PGF	Pot	LS PG P.3.7	1				1				VB19.2910.145	Pl. 5.4, n°41
2910		PGF	Indét.				15		15					
2910	1	RALUIS	Indét.				1		1			Ponctuations à la barbotine		
2910	1	EIR	Plat	LS EIR A.2.2	1				1					
2910	1	EIRN	Plat	LS EIR A.2.5 var.	1				1				VB19.2910.142	Pl. 5.4, n°42

2910	3	MICAC	Bol à marli	LS MIC B.2.5	1				1				VB19.2910.134	Pl. 5.4, n°43
2910		MICAC	Pot	cf. LS PC P.1.1.a	1				1					
2910		MICAC	Bol?	Indét.	1				1				VB19.2910.85	
2910		MICAC	Indét.		1		26		27					
2910	11	PGTN	Gobelet	LS PG G.1.2	1				1				VB19.2910.141	Pl. 5.4, n°44
2320		PGTN	Gobelet	LS PG G.1.2	1				2					
2910		PGTN	Pot	LS PG P.3.1	4				6					
2910		PGTN	Pot	LS PG P.3.5	1				1				VB19.2910.138	Pl. 5.4, n°45
2910		PGTN	Pot	LS PG P.3.7.a	1				1					
2910		PGTN	Pot	LS PG P.3.7.a	1				1				VB19.2910.136	Pl. 5.4, n°46
2320		PGTN	Pot	LS PG P.3.7.b			1		1	Guilloché				
2910		PGTN	Pot	LS PG P.3.7	1				1					
2320		PGTN	Pot	Indét.	1				1					
2910		PGTN	Indét.				2		2	Godrons et lignes lissées				
2910		PGTN	Indét.		2		5		7					
2910		PGTN	Indét.				1		1	Ponctuations à la barbotine				
2910		PGTN	Indét.				1		1					
2320		PGTN	Indét.				1		1	Godrons				
2320		PGTN	Indét.		1		4		5					
2910	5	PCCRU	Cruche	LS CRU Cr.2.1	2				2					
2910		PCCRU	Cruche	LS CRU Cr.2.2.a	1				1				VB19.2910.135	Pl. 5.4, n°47
2910		PCCRU	Cruche	LS CRU Cr.3.1	1				2					
2910		PCCRU	Cruche	LS CRU Cr.3.9	1				1					
2910		PCCRU	Cruche	Indét.		6	386	3	395					
2320		PCCRU	Cruche	Indét.			5		5					
2910	1	PCMOR	Mortier	LS MOR Mo.3.3	1				1				VB19.2910.140	Pl. 5.5, n°48
2910		PCMOR	Mortier	Indét.			3		3		dont une collerette			
2910	2	PC	Pot à provision	LS PC P.1.10 approx.	1				1				VB19.2910.139	Pl. 5.5, n°49
2910		PC	Couvercle	LS PC Cv.2.1.b	1				1					
2910		PC	Indét.		1	2	34		37					
2910		PC	Indét.				1		1		kaolinithique			
2320		PC	Indét.				4		4					

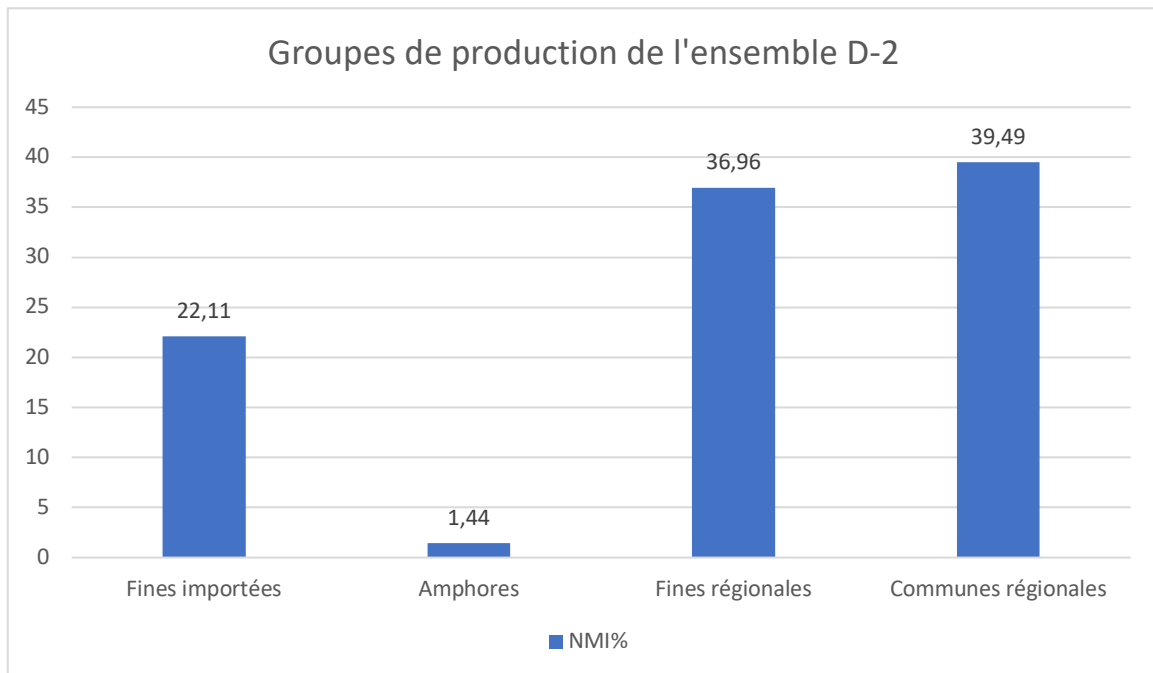
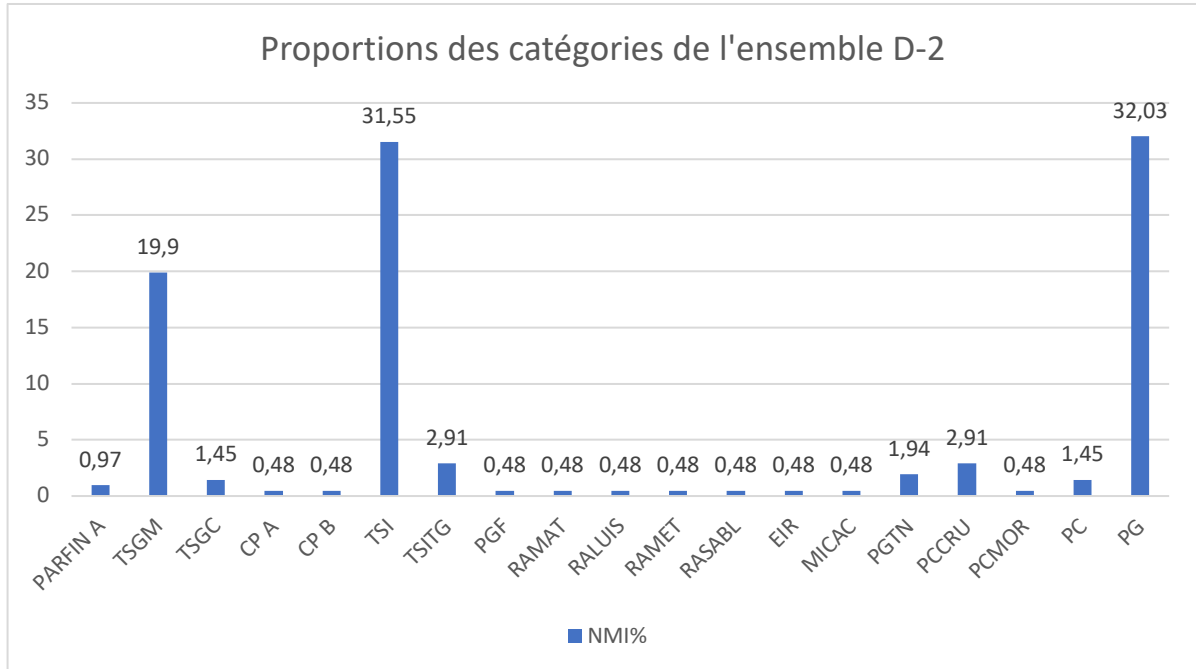
2910	51	PG	Ecuelle/Jatte	LS PG E.1.1	1				1					VB19.2910.123	Pl. 5.5, n°50
2320		PG	Ecuelle/Jatte	LS PG E.1.6 (var.)				1	1						
2910		PG	Marmite tripode	LS PG E.1.7.a	1				1						
2910		PG	Marmite tripode	LS PG E.1.7.b	1				1						
2910		PG	Marmite tripode	LS PG E.1.7.b	1				2	Lignes lissées					
2910		PG	Marmite tripode	LS PG Ma.1.7.c	1				1	Lignes lissées					
2910		PG	Marmite tripode	LS PG Ma.1.7.c	2				2						
2910		PG	Marmite tripode	LS PG Ma.1.7.c	1				1					VB19.2910.119	Pl. 5.5, n°51
2910		PG	Marmite tripode	LS PG Ma.1.7.c	1				1					VB19.2910.144	Pl. 5.5, n°52
2910		PG	Ecuelle/Jatte	LS PG E.2.7.a	2				3	Peigné					
2320		PG	Ecuelle/Jatte	LS PG E.2.7.a	1				1						
2910		PG	Ecuelle/Jatte	LS PG E.2.7.a	1				1					VB19.2910.133	Pl. 5.5, n°53
2910		PG	Ecuelle/Jatte	LS PG E.2.7.b	1				1	Peigné				VB19.2910.120	Pl. 5.5, n°54
2910		PG	Ecuelle/Jatte	LS PG E.2.7	1				1						
2910		PG	Ecuelle/Jatte	LS PG E.5.2	1				1					VB19.2910.124	Pl. 5.5, n°55
2910		PG	Gobelet	LS PG G.1.2	1				1					VB19.2910.132	Pl. 5.5, n°56
2910		PG	Pot	LS PG P.1.2.b	2				2	Peigné					
2910		PG	Pot	LS PG P.1.2.b	1				1						
2910		PG	Pot	LS PG P.1.2.b	1				1	Peigné				VB19.2910.121	Pl. 5.5, n°57
2910		PG	Pot	LS PG P.1.3.a	1				1					VB19.2910.130	Pl. 5.5, n°58
2910		PG	Pot	LS PG P.1.3.b	1				1						
2910		PG	Pot	LS PG P.1.3.b	1				1					VB19.2910.122	Pl. 5.5, n°59
2910		PG	Pot	LS PG P.1.3.b	1				1	Peigné					
2910		PG	Pot	LS PG P.2.6	1				2						
2910		PG	Pot	LS PG P.3.3	1				1	Impressions rect. et lignes lissées				VB19.2910.118	Pl. 5.6, n°60
2910		PG	Pot	LS PG P.3.4	1				1					VB19.2910.127	Pl. 5.6, n°61
2910		PG	Pot	LS PG P.3.5	2				3	Lignes lissées					
2910		PG	Pot	LS PG P.3.5	4				4						
2910		PG	Pot	LS PG P.3.7.a	1				1	Lignes lissées					
2910		PG	Pot	LS PG P.3.7.a	1				1					VB19.2910.125	Pl. 5.6, n°62
2910		PG	Pot	LS PG P.3.7.a	1				1					VB19.2910.129	Pl. 5.6, n°63
2320		PG	Pot	LS PG P.3.7	1				2						
2910		PG	Couvercle	LS PG Cv.1.1	3				3						
2910		PG	Couvercle	LS PG Cv.1.1	1				1					VB19.2910.143	Pl. 5.6, n°64
2320		PG	Couvercle	LS PG Cv.2.1	1				2						
2910		PG	Couvercle	LS PG Cv.2.1	1				1					VB19.2910.126	Pl. 5.6, n°65
2320		PG	Couvercle	LS PG Cv.3.1	1				1						
2910		PG	Couvercle	LS PG Cv.3.1	1				1					VB19.2910.137	Pl. 5.6, n°66
2910		PG	Couvercle	LS PG Cv.3.1	1				1						
2910		PG	Couvercle	LS PG Cv.3.2.a	2				2						
2910		PG	Couvercle	LS PG Cv.3.2.a	1				1					VB19.2910.128	Pl. 5.6, n°67
2910		PG	Marmite tripode	Indét.		1			1	Lignes lissées croisées					
2910		PG	Marmite tripode	Indét.		2			2	Lignes lissées					
2910		PG	Couvercle	indèt.	2				2						
2910		PG	Indét.				1		1	Peigné, tenon de préhension					
2910		PG	Indét.				12		12	Lignes lissées					
2910		PG	Indét.				46		46	Peigné					
2910		PG	Indét.				13		13	Impressions rectangles					
2910		PG	Indét.				2		2	Impressions digitées					
2910		PG	Indét.				2		2	Impressions carrées					
2910		PG	Indét.				1		1	Occulé					
2910		PG	Indét.		2	3	212		217						
2910		PG	Indét.				1		1	Impressions triangles					
2910		PG	Indét.				3		3	Lignes lissées croisées					
2320		PG	Indét.				1		1	Peigné					
2320		PG	Indét.		1		9		13						
2320		PG	Indét.				2		2	Impressions rectangles					
TOTAUX	214				8	7	305	4	3	1488					

Fig. 10.3: Tableau des amphores de l'ensemble D-1.

UF	NMI	Categorie	Type	Bord	Fond	Panse	Anse	Profil	NR	Décor	Commentaire	Inscription	Inventaire	Illustration
2910	1		Indét.			2			2					
2910	1	Bétique	Dressel 20			2			2					
2320		Bétique	Dressel 20				1		1					
2910	1	Gaule	Indét.			4			4					
TOTAUX	3					8	1		9					

3.2.6. Ensemble D-2 - Période D-2 (150/180 ap. J.-C.) (Pl. 6.1-6.5)

Fig. 11.1: Proportions choisies de l'ensemble D-2 (NMI exprimé en pourcents).



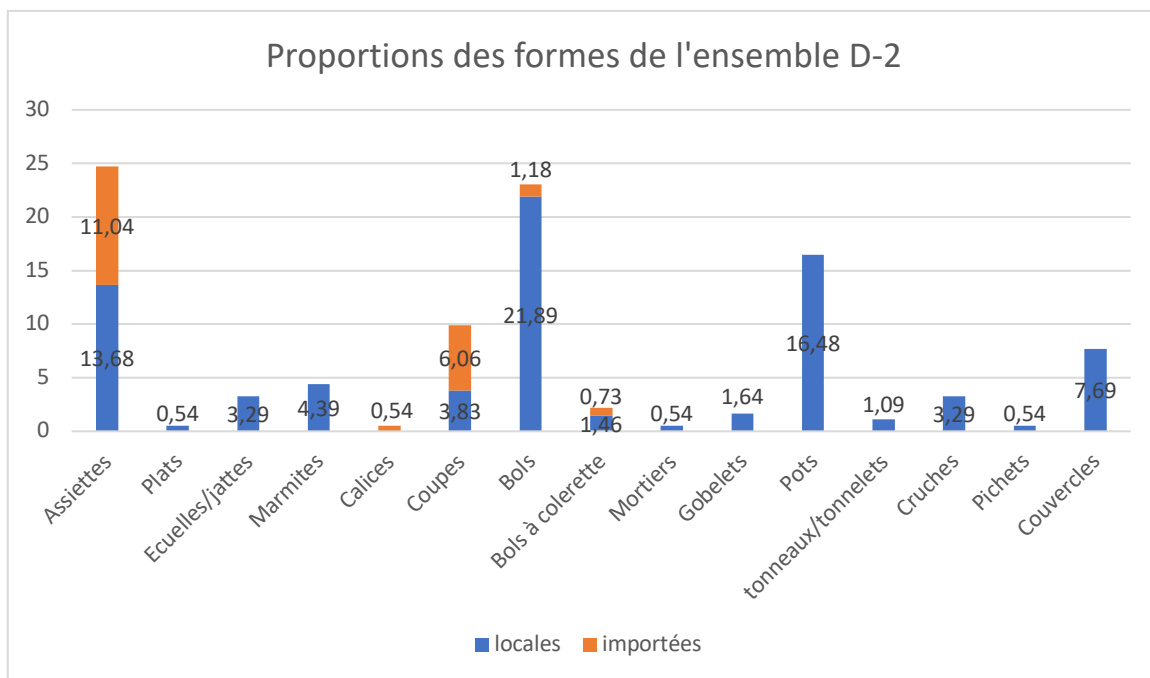
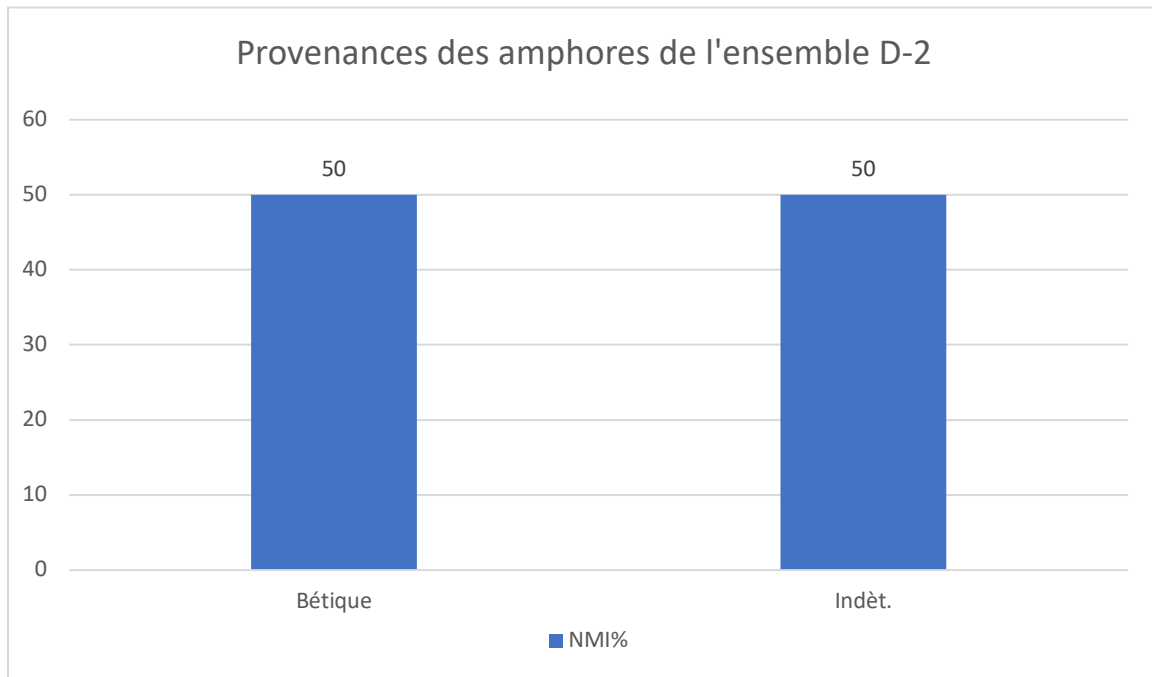


Fig. 11.2: Tableau des céramiques de l'ensemble D-2.

UF	NMI	Categorie	Forme	Type	Bord	Fond	Panse	Anse	Profil	NR	Décor	Commentaire	Inscription	Inventaire	Illustration
2089	2	PARFIN A	Coupe	Bertrand 5.1	1					1					
2089		PARFIN A	Coupe	Bertrand 5.1	1					1				VB18.2089.84	Pl. 6.2, n°12
2089		PARFIN A	Coupe	indét.			1			1	Sablé				
2089		PARFIN A	Indét.			1	1			2					
2089		PARFIN A	Indét.				1			1	disques à la barbotine				
2089	41	TSGM	Assiette	Drag. 15A	1					2					
2089		TSGM	Assiette	Drag. 15/17A	1					3				VB18.2089.49	Pl. 6.1, n°1
2089		TSGM	Assiette	Drag. 15/17	10		3			13					
2089		TSGM	Assiette	Drag. 15/17	1					1				VB18.2089.60	Pl. 6.1, n°2
2089		TSGM	Assiette	Drag. 15/17	1					1				VB18.2089.77	Pl. 6.1, n°3
2089		TSGM	Assiette	Drag. 15/17	1					1				VB18.2089.79	Pl. 6.1, n°4
2089		TSGM	Assiette	Drag. 18	3					3					
2089		TSGM	Assiette	Drag. 18	1					1				VB18.2089.63	Pl. 6.1, n°5
2089		TSGM	Calice	Drag. 11a		1				1					
2089		TSGM	Coupe	Drag. 4/22					1	1		diamètre 7-11 cm		VB18.2089.52	Pl. 6.1, n°8
2089		TSGM	Coupe	Drag. 4/22	7	3	1			11		diamètre 7-11 cm			
2089		TSGM	Coupe	Drag. 27	4		2			6					
2089		TSGM	Coupe	Drag. 27	1					1				VB18.2089.67	Pl. 6.1, n°6
2089		TSGM	Coupe	Ritt. 9					1	5			Estampille: OF IV [---] NDI	VB19.2089.08	Pl. 6.1, n°9
2089		TSGM	Coupe	Ritt. 14B	2					2					
2089		TSGM	Bol	Drag. 29b	1					1				VB18.2089.61	Pl. 6.1, n°10
2089		TSGM	Bol	Drag. 37			2			3					
2089		TSGM	Bol à colerette	Ritt. 12	2		3			7					
2089		TSGM	Bol à colerette	Ritt. 12	1					1				VB18.2089.73	Pl. 6.1, n°11
2089		TSGM	Indét.		8	9	84			102					
2089	3	TSGC	Assiette	Drag. 18	2					2					
2089		TSGC	Coupe	Drag. 27	1					1				VB18.2089.72	Pl. 6.1, n°7
2089		TSGC	Indét.		3	1	7			11					
2089	1	CP A	Indét.			1	18			23					
2089		CP A	Indét.				1			1	Bandeau blanc/lie de vin				
2089		CP A	Indét.				1			1	Bandeau blanc/lie de vin + échelles				
2089	1	CP B	Indét.				1			1					
2089	65	TSI	Assiette	imit. Ha. 2 / Drag. 17a, L2	1					1					
2089		TSI	Assiette	Drack 4, L4	10					10					
2089		TSI	Assiette	Drack 4, L4	1					1				VB19.2089.19	Pl. 6.2, n°13
2089		TSI	Assiette	Drack 4, L4	1					1				VB18.2089.83	Pl. 6.2, n°14
2089		TSI	Assiette	imit. Drag. 18, L6	2					4		(dont 1 bd de la Péniche)			
2089		TSI	Assiette	imit. Drag. 15/17, L7a	2					2					
2089		TSI	Assiette	Imit. Drag. 15/17, L7b	2					2					

2089		TSI	Assiette	imit. Drag. 15/17, L7b	1				1			VB18.2089.78	Pl. 6.2, n°15
2089		TSI	Assiette	imit. Drag. 15/17, L7			4		4				
2089		TSI	Assiette	imit. Ritt. 14b, L14	1				1			VB19.2089.14	Pl. 6.2, n°16
2089		TSI	Assiette	imit. Drag. 18, L6	1				1			VB18.2089.70	Pl. 6.2, n°17
2089		TSI	Assiette	Péniche 3, L12	1				2			VB18.2089.03	Pl. 6.2, n°18
2089		TSI	Coupe	imit. Drag. 22, L9	1				1				
2089		TSI	Coupe	imit. Drag. 24/25, L29a	2		2		8				
2089		TSI	Coupe	imit. Drag. 24/25, L29b	1				1			VB18.2089.50	Pl. 6.2, n°19
2089		TSI	Coupe	imit. Drag. 27, L30	1				2				
2089		TSI	Coupe	imit. Drag. 27, L30	1				1			VB19.2089.16	Pl. 6.2, n°20
2089		TSI	Bol	Drack 21, L40c	1				1			VB18.2089.69	Pl. 6.2, n°22
2089		TSI	Bol	Drack 21, L40c	1				1			VB18.2089.76	Pl. 6.2, n°23
2089		TSI	Bol	Drack 21, L40d	4				5				
2089		TSI	Bol	Drack 21, L40c	21		1		23				
2089		TSI	Bol	Drack 21, L40d	1				1			VB18.2089.55	Pl. 6.2, n°24
2089		TSI	Bol	Drack 21, L40d	1				1			VB18.2089.66	Pl. 6.2, n°25
2089		TSI	Bol	Drack 21	5		9		15				
2089		TSI	Bol à colerette	Drack 19, imit. Ritt. 12, L49	1		3		4		dont 2 colerettes		
2089		TSI	Tonneau/tonnele	L56a	1				1			VB19.2089.15	Pl. 6.3, n°26
2089		TSI	Indét.		16	42	316	3	378		(dont 1 pn de la Péniche)		
2089		TSI	Indét.			1			1		Estampille: NA[---]	VB18.2089.34	Pl. 6.3, n°27
2089	6	TSITG	Coupe	imit. Drag. 22, L9	1				1				
2089		TSITG	Coupe	imit. Drag. 27, L30	4	1	1		7				
2089		TSITG	Coupe	imit. Drag. 27, L30	1				1			VB18.2089.58	Pl. 6.2, n°21
2089		TSITG	Indét.		1		8		9				
2089	1	PGF	Indét.		1		5		6				
2089	1	RALUIS	Gobelet	Indét.			1		1				
2089	1	RAMAT	Pot	indét.	1				1				
2089		RAMAT	Pot	Indét.		1			1	Barbotine			0
2089		RAMAT	Indét.				3		3				
2089	1	RAMET	Indét.				1		1				
2089	1	RASABL	Indét.				1		1				
2089	1	EIR	Plat	LS EIR A.2.2	1				1				
2089		EIR	Plat	Indét.		1	5		7				
2089	1	MICAC	Indét.				6		6				
2089	4	PGTN	Gobelet	cf. AV 11	1				1			VB18.2089.75	Pl. 6.3, n°28
2089		PGTN	Pot	LS PG P.3.3	1				1				
2089		PGTN	Pot	LS PG P.3.7.b			1		8	Godrons, lignes lissées, point à la barbotine			
2089		PGTN	Pot	LS PG P.3.7	2				2				
2089		PGTN	Indét.				9		10				
2089		PGTN	Indét.				2		2	Godrons			
2089	6	PCCRU	Cruche	LS CRU Cr.1.2	1				1			VB19.2089.13	Pl. 6.3, n°29
2089		PCCRU	Cruche	LS CRU Cr.2.2.a	1				1				
2089		PCCRU	Cruche	LS CRU Cr.2.2.b	1				3				
2089		PCCRU	Cruche	LS CRU Cr.3.3.b	1				2				
2089		PCCRU	Cruche	LS CRU Cr.3.6 approx.	1				1				
2089		PCCRU	Cruche	AV 321/2 var.	1				2			VB18.2089.65	Pl. 6.3, n°30
2089		PCCRU	Cruche	indét.	2	6	273	6	288				
2089	1	PCMOR	Mortier	LS MOR MO.3.3	1				4			VB18.2089.04	Pl. 6.3, n°31
2089		PCMOR	Mortier	Indét.		1	3		4	dont 1 colerette			
2089	3	PC	Pot	LS PC P.1.10			1		1				
2089		PC	Pot	LS PC P.1.10.a	1				1				
2089		PC	Couvercle	LS PC Cv.2.1.b	1				1			VB18.2089.64	Pl. 6.3, n°32
2089		PC	Couvercle	LS PC Cv.3.1	1				1				
2089		PC	Couvercle	Indét.	1				1				
2089		PC	Indét.		2	4	87		93				

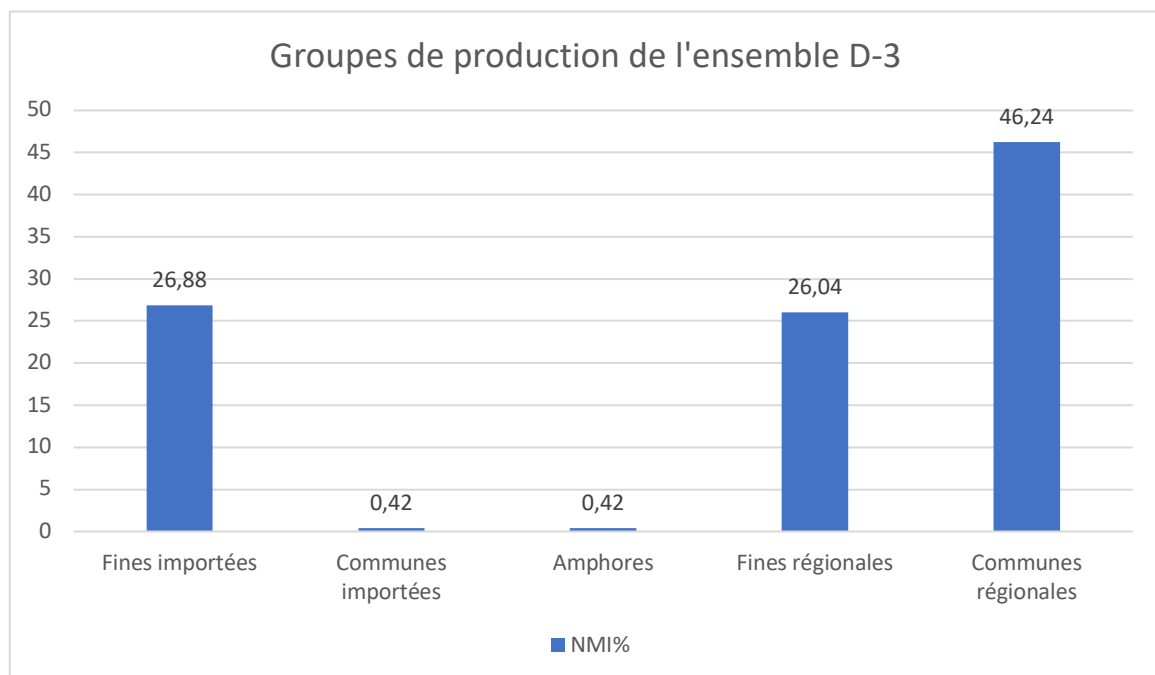
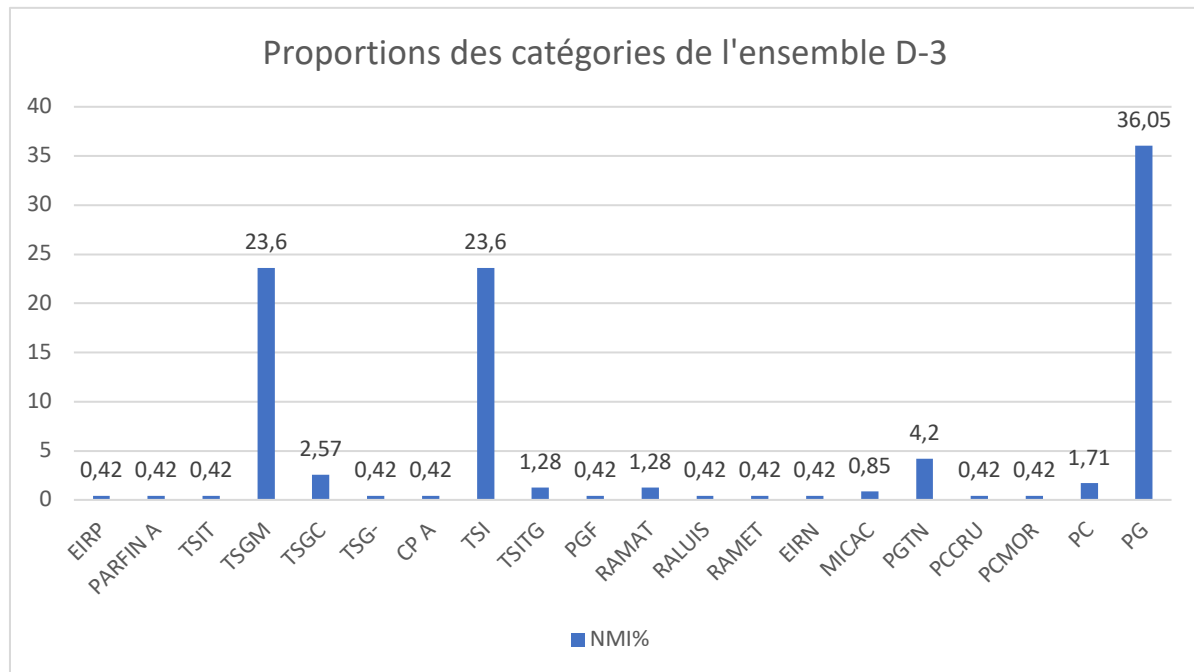
2089	66	PG	Assiette	HT	1					2				VB18.2089.48	Pl. 6.3, n°33
2089		PG	Marmite tripode	LS PG Ma.1.7.a	1					1				VB18.2089.81	Pl. 6.3, n°34
2089		PG	Marmite tripode	LS PG Ma.1.7.b	2					2					
2089		PG	Marmite tripode	LS PG Ma.1.7.c	1					1					
2089		PG	Marmite tripode	LS PG Ma.1.7.c	2					2	Lignes lissées				
2089		PG	Marmite tripode	LS PG Ma.1.7.c	1					1				VB18.2089.53	Pl. 6.3, n°35
2089		PG	Marmite tripode	LS PG Ma.1.7.c				1		2	Lignes lissées			VB18.2089.62	Pl. 6.3, n°36
2089		PG	Ecuelle/Jatte	LS PG E.2.6	1					1				VB18.2089.80	Pl. 6.3, n°37
2089		PG	Ecuelle/Jatte	LS PG E.2.7.a	2					2					
2089		PG	Ecuelle/Jatte	LS PG E.2.7.a	1					1				VB18.2089.56	Pl. 6.4, n°38
2089		PG	Ecuelle/Jatte	LS PG E.2.7.c	1		2			3	surcuit				
2089		PG	Bol	LS PG B.5.2	2					2					
2089		PG	Bol	LS PG B.5.2				1		1	Impression	impression de rectangle sous la carène			
2089		PG	Bol	LS PG B.5.2	1					1				VB18.2089.68	Pl. 6.4, n°39
2089		PG	Gobelet	LS PG G.1.2	1					1	Guilloché			VB19.2089.18	Pl. 6.4, n°40
2089		PG	Pot	LS PG P.1.1.a	2					2					
2089		PG	Pot	LS PG P.1.3.b	4					4					
2089		PG	Pot	LS PG P.1.3.b	1					1				VB18.2089.71	Pl. 6.4, n°41
2089		PG	Pot	LS PG P.1.6	1					1				VB18.2089.57	Pl. 6.4, n°42
2089		PG	Pot	LS PG P.2.6	1					1	Peigné				
2089		PG	Pot	LS PG P.2.10	2					2					
2089		PG	Pot	LS PG P.2.10	1					1				VB18.2089.54	Pl. 6.4, n°43
2089		PG	Pot	LS PG P.3			3			4					
2089		PG	Pot	LS PG P.3.1	1					1					
2089		PG	Pot	LS PG P.3.5	1					1				VB18.2089.74	Pl. 6.4, n°44
2089		PG	Pot	LS PG P.3.7.a	7					10					
2089		PG	Pot	LS PG P.3.7.b	1					1				VB18.2089.51	Pl. 6.4, n°45
2089		PG	Pot	LS PG P.3.7	1					1					
2089		PG	Tonneau/tonnele	LS PG T.1.1.c	1					1					
2089		PG	Pichet	LS PG Pi.2.1	1					1				VB19.2089.17	Pl. 6.4, n°46
2089		PG	Couvercle	LS PG Cv.1.1	1					1					
2089		PG	Couvercle	LS PG Cv.3.1	3					3					
2089		PG	Couvercle	LS PG Cv.3.2.a	6					6					
2089		PG	Couvercle	LS PG Cv.3.2.a	1					1				VB18.2089.59	Pl. 6.5, n°47
2089		PG	Couvercle	LS PG Cv.3.2.a	1					1				VB18.2089.82	Pl. 6.5, n°48
2089		PG	Pot	Indét.	1					1					
2089		PG	Pot	indét.	7	1				11					
2089		PG	Marmite tripode	Indét.		2				2	Lignes lissées				
2089		PG	Couvercle	Indét.	1					1					
2089		PG	Indét.		11	22	334			369					
2089		PG	Indét.				46			46	Peigné				
2089		PG	Indét.			2				2	Lignes lissées croisées				
2089		PG	Indét.				2			2	Cordon de préhension				
2089		PG	Indét.				1			1					
2089		PG	Indét.				1			1	tenon de préhension digité				
2089		PG	Indét.				1			1	Impressions carrées				
2089		PG	Indét.				1			1	Impressions rectangles				
2089		PG	Indét.			8	5			14	Lignes lissées				
2089		PG	Indét.				2			3	Lignes lissées croisées				
TOTAUX	206				31	37	391	9	4	1682					

Fig. 11.3: Tableau des amphores de l'ensemble D-2.

UF		Categorie	Type	Bord	Fond	Panse	Anse	Profil	NR	Décor	Commentaire	Inscription	Inventaire	Illustration
2089	1	Bétique	Dressel 20			1			1					
2089	1		Indét.	1					1					
2089			Indét.			4			4					
TOTAUX	2			1		5			6					

3.2.7. Ensemble D-3 – Période D-3 (180 ap. J.-C.) (PI 7.1-7.8)

Fig. 12.1: Proportions choisies de l'ensemble D-3 (NMI exprimé en pourcents).



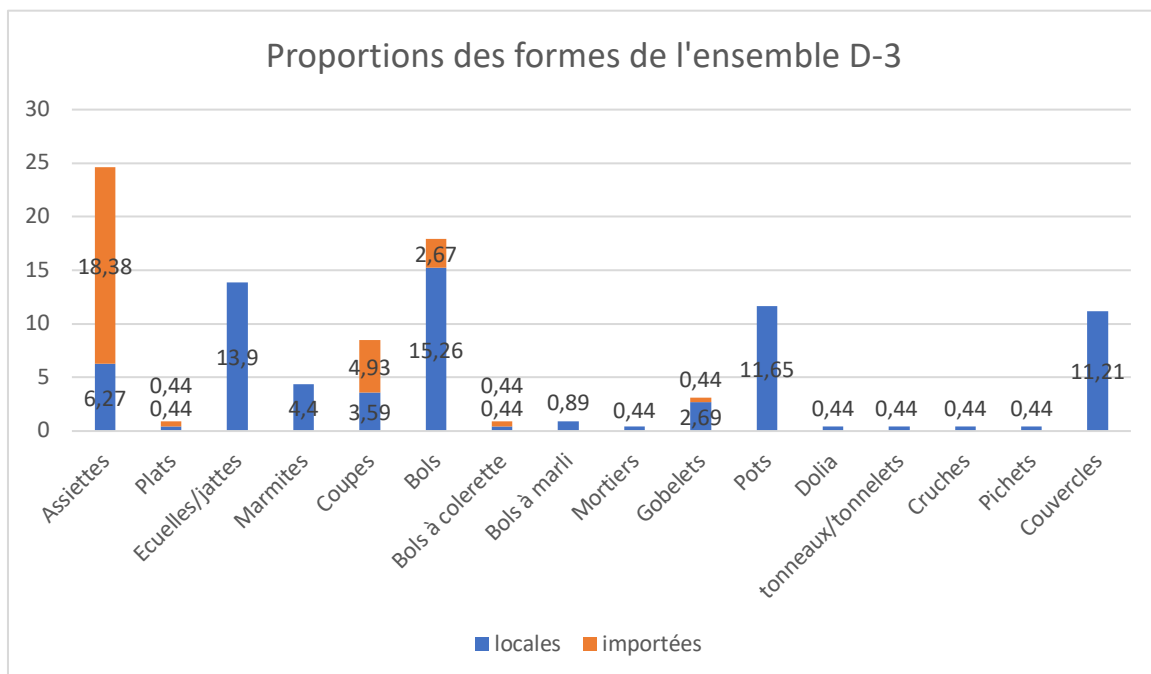
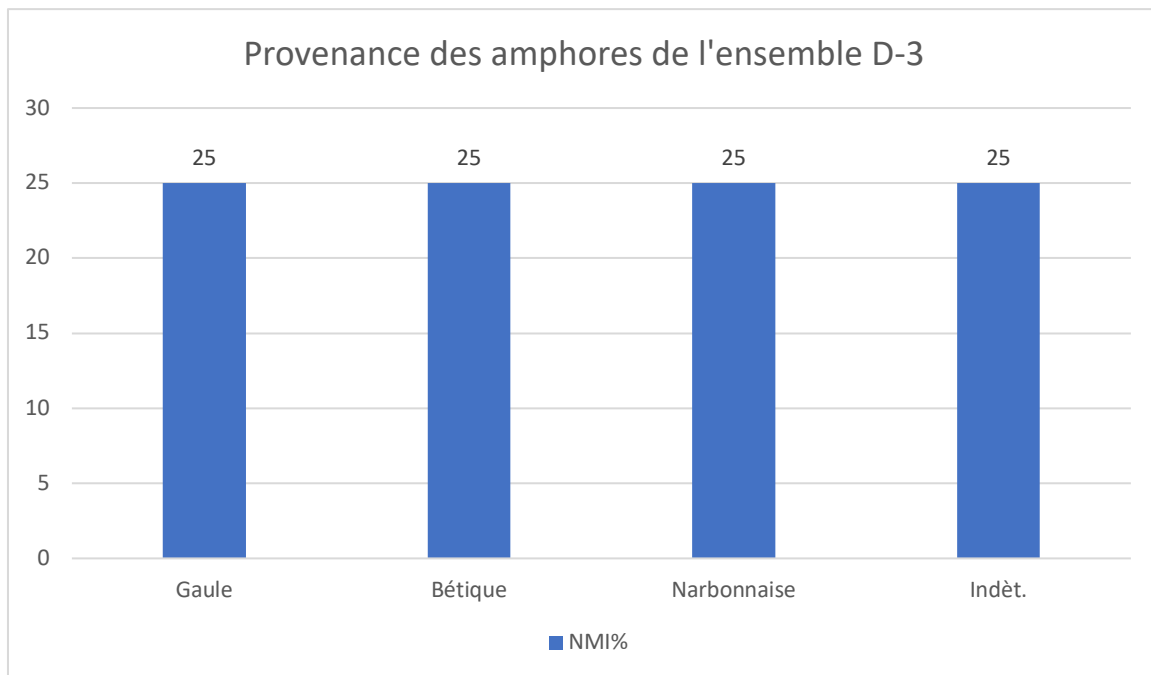


Fig. 12.2: Tableau des céramiques de l'ensemble D-3.

UF	NMI	Categorie	Forme	Type	Bord	Fond	Panse	Anse	Profil	NR	Décor	Commentaire	Inscription	Inventaire	Illustration
1599	1	PARFIN A	Gobelet	indét.			1			1	Sablé				
1656		PARFIN A	Indét.				1			1	Écaillés à la barbotine				
1656	1	TSIT	Assiette	Ha. 2	1					1				VB16.1656.24	Pl. 7.1, n°1
1656	55	TSGM	Assiette	Drag. 15/17C	1					1				VB16.1656.15	Pl. 7.1, n°2
1808		TSGM	Assiette	Drag. 15/17	3					3					
1808		TSGM	Assiette	Drag. 15/17	1					1				VB17.1808.09	Pl. 7.1, n°3
1656		TSGM	Assiette	Drag. 15/17	2					4					
1599		TSGM	Assiette	Drag. 15/17	2		1			3					
1808		TSGM	Assiette	Drag. 18B	1					2		graf : X ou croix et suite illisible		VB17.1808.05	Pl. 7.1, n°4
1656		TSGM	Assiette	Drag. 18	1					1				VB16.1656.27	Pl. 7.1, n°5
1599		TSGM	Assiette	Drag. 18	1					1				VB16.1599.29	Pl. 7.1, n°6
1808		TSGM	Assiette	Drag. 18	1					1				VB17.1808.14	Pl. 7.1, n°7
1656		TSGM	Assiette	Drag. 18	4					4					
1563		TSGM	Assiette	Drag. 18	1					1					
1599		TSGM	Assiette	Drag. 18	3					4					
1656		TSGM	Assiette	Drag. 36			2			2	Feuille d'eau				
1656		TSGM	Assiette	Drag. 36	1		1			1	Feuille d'eau			VB16.1656.19	Pl. 7.1, n°8
1563		TSGM	Assiette	Drag. 36	1					1	Feuille d'eau			VB16.1563.21	Pl. 7.1, n°9
1563		TSGM	Assiette	Drag. 36	6		5			11	Feuille d'eau				
1599		TSGM	Assiette	Drag. 36	5		1			8	Feuille d'eau				
1808		TSGM	Assiette	Drag. 36	1					1	Feuille d'eau				
1656		TSGM	Assiette	Drag. 4/22		1				1					
1599		TSGM	Assiette	Curle 15	1					1				VB16.1599.16	Pl. 7.1, n°10
1563		TSGM	Assiette	Herm. 12c					1	2				VB16.1563.13	Pl. 7.1, n°11
1599		TSGM	Coupe	Drag. 4/22	1					2				VB16.1599.30	Pl. 7.1, n°12
1599		TSGM	Coupe	Drag. 4/22		1				4					
1599		TSGM	Assiette	Curle 15	1					1					
1656		TSGM	Coupe	Drag. 27				1		1					
1808		TSGM	Coupe	Drag. 35	1					1	Feuille d'eau				
1808		TSGM	Coupe	Drag. 4/22					1	1				VB17.1808.08	Pl. 7.2, n°13
1808		TSGM	Coupe	Ritt. 9			1			1					
1563		TSGM	Coupe	Curle 15	1					6				VB16.1563.14	Pl. 7.2, n°14
1656		TSGM	Coupe	Curle 23					1	1		Estampille : rosette		VB16.1656.17	Pl. 7.2, n°15
1656		TSGM	Coupe	Knorr 78			1			1					
1808		TSGM	Bol	Drag. 29b	1					3				VB17.1808.07	Pl. 7.2, n°17
1563		TSGM	Bol	Drag. 29b ?	1					1					
1599		TSGM	Bol	Drag. 29b	1					1					
1808		TSGM	Bol	Drag. 29	1		3			4					
1808		TSGM	Bol	Drag. 29				1		1					
1656		TSGM	Bol	Drag. 29				1		1					
1563		TSGM	Bol	Drag. 29				3		3					
1808		TSGM	Bol	Drag. 37				2		2					
1808		TSGM	Bol à colerette	Ritt. 12				1		1		1fgrt de lèvres sans colerette			
1656		TSGM	Bol à colerette	Ritt. 12C	1					2				VB16.1656.16	Pl. 7.2, n°19
1656		TSGM	Assiette	indét.			1			1					
1599		TSGM	Assiette	indét.			1			3		graffito : M		VB16.1599.17	
1599		TSGM	Bol	indét.				26		26					
1599		TSGM	Coupe	indét.			1			1					
1808		TSGM	Coupe	indét.			1			3					
1808		TSGM	Indét.				1			2		Est : MADVILMA		VB17.1808.04	Pl. 7.2, n°20
1808		TSGM	Indét.		1			4		5					
1656		TSGM	Indét.					3		3					
1563		TSGM	Indét.			1				9					

1656	3	TSITG	Assiette	Drack 4, L4	1				1				VB17.1656.03	Pl. 7.3, n°28
1808		TSITG	Bol	Drack 20, L39	1				1				VB18.1808.03	Pl. 7.4, n°34
1808		TSITG	Bol	Drack 21, L40c	1				1					
1656		TSITG	Assiette	indét.			2		2					
1656		TSITG	Indét.				2		2					
1563		TSITG	Indét.		1		4		5					
1599		TSITG	Indét.			1			1					
1808	1	PGF	Indét.				1		1					
1656	3	RAMAT	Bol à marli	LS RA B.2.2	1		2		3					
1656		RAMAT	Bol à marli	LS RA B.2.2	1				1				VB16.1656.26	Pl. 7.4, n°41
1656		RAMAT	Indét.				1		1					
1563	1	RALUIS	Gobelet	indét.			3		4					
1599		RALUIS	Gobelet	indét.			1		1	Cordons fendus				
1808	1	RAMET	Gobelet	LS RA G.2.3.b	1				1				VB17.1808.03	Pl. 7.5, n°42
1563	1	EIRN	Plat	indét.		1			1					
1599		EIRN	Plat	indét.		1			1					
1563	2	MICAC	Couvercle	LS MIC Cv.1.1	1				1				VB16.1563.26	Pl. 7.5, n°43
1563		MICAC	Couvercle	cf LS PG Cv.3.2.a	1				1					
1656		MICAC	Indét.				3		3					
1808	10	PGTN	Gobelet	LS PG G.1.1	1		1		2	Godrons				
1808		PGTN	Gobelet	LS PG G.1.1	1				1				VB17.1808.13	Pl. 7.5, n°44
1599		PGTN	Gobelet	LS PG G.1.2	1				1				VB16.1599.40	Pl. 7.5, n°45
1563		PGTN	Pot	LS PG P.3.7	1				1					
1563		PGTN	Pot	LS PG P.3.7.b	2				2					
1563		PGTN	Pot	LS PG P.3.7.b	1		3		4	Guilloché				
1563		PGTN	Pot	LS PG P.3.7.b	1				1				VB16.1563.24	Pl. 7.5, n°46
1563		PGTN	Pot	AV 69 (var.)	1				1	Impressions rectangles			VB16.1563.20	Pl. 7.5, n°47
1656		PGTN	Pot	indét.			7		7	Godrons et lignes lissées				
1656		PGTN	Pot	indét.	1				1		brûlé (surface rouge ocre)			
1656		PGTN	Tonneau/tonnelet	indét.			10		10					
1808		PGTN	Indét.		2		1		3					
1563		PGTN	Indét.				5		5					
1563		PGTN	Indét.				1		1	Lignes lissées				
1599		PGTN	Indét.				3		3					
1599		PGTN	Indét.				10		10	Godrons				
1599	1	PCCRU	Cruche	LS CRU Cr.1.2	1				2				VB16.1599.31	Pl. 7.5, n°48
1808		PCCRU	Cruche	Indét.		3	33		36					
1656		PCCRU	Cruche	indét.			40	1	41					
1563		PCCRU	Cruche	indét.		1	32		33					
1599		PCCRU	Cruche	indét.		3	24	1	28					
1808	1	PCMOR	Mortier	Indét.		2	2		4					
1563		PCMOR	Mortier	indét.	2	1	1		4		2 frgts de collerette			

1808	4	PC	Couvercle	LS PC Cv.2.1.b	1				1				
1599		PC	Couvercle	LS PC Cv.2.1.b	1				2			VB16.1599.33	Pl. 7.5, n°49
1599		PC	Couvercle	HT	1				1			VB16.1599.32	Pl. 7.5, n°50
1599		PC	Pot	indét.		2			2				
1808		PC	Couvercle	Indét.	1		1		2				
1808		PC	Indét.				8	1	9				
1656		PC	Indét.				8		8				
1806		PC	Indét.				1		1				
1563		PC	Indét.				4		4				
1599		PC	Indét.				11		11				
1599	84	PG	Assiette	LS PG A.1.3	1				1				
1563		PG	Ecuelle/Jatte	LS PG E.1.1.a				1	1			VB16.1563.12	Pl. 7.5, n°51
1808		PG	Ecuelle/Jatte	LS PG E.1.1.a				1	1			VB17.1808.10	Pl. 7.5, n°52
1656		PG	Ecuelle/Jatte	LS PG E.1.1.a				1	1				
1599		PG	Ecuelle/Jatte	LS PG E.1.1.a	3				3				
1599		PG	Ecuelle/Jatte	LS PG E.1.1.b				1	1			VB16.1599.43	Pl. 7.5, n°53
1808		PG	Ecuelle/Jatte	LS PG E.1.1	1				2				
1656		PG	Ecuelle/Jatte	LS PG E.1.1	1				1	Lignes lissées		VB16.1656.28	Pl. 7.6, n°54
1656		PG	Ecuelle/Jatte	LS PG E.1.1	2				2				
1563		PG	Ecuelle/Jatte	LS PG E.1.1	1				1				
1599		PG	Ecuelle/Jatte	LS PG E.1.6.a	1				1			VB16.1599.42	Pl. 7.6, n°55
1599		PG	Marmite tripode	LS PG Ma.1.7.b	3				3				
1808		PG	Marmite tripode	LS PG Ma.1.7.c	1				1			VB17.1808.11	Pl. 7.6, n°56
1808		PG	Marmite tripode	LS PG Ma.1.7.c	1				1				
1656		PG	Marmite tripode	LS PG Ma.1.7.c	1				1	Lignes lissées			
1656		PG	Marmite tripode	LS PG Ma.1.7.c	1				1				
1563		PG	Marmite tripode	LS PG Ma.1.7.c	1				2				
1563		PG	Marmite tripode	LS PG Ma.1.7.c	1				2	Lignes lissées croisées		VB16.1563.22	Pl. 7.6, n°57
1563		PG	Marmite tripode	LS PG Ma.1.7	1				1				
1599		PG	Ecuelle/Jatte	LS PG E.2.3	1				1				
1599		PG	Ecuelle/Jatte	LS PG E.2.3	1				1			VB16.1599.37	Pl. 7.6, n°58
1656		PG	Ecuelle/Jatte	LS PG E.2.6	1				1				
1563		PG	Ecuelle/Jatte	LS PG E.2.6	1				1	Peigné			
1599		PG	Ecuelle/Jatte	LS PG E.2.7.a	4				4				
1656		PG	Ecuelle/Jatte	LS PG E.2.7.a	1				1			VB17.1656.05	Pl. 7.6, n°59
1563		PG	Ecuelle/Jatte	LS PG E.2.7.a	1				1	Peigné			
1599		PG	Ecuelle/Jatte	LS PG E.2.7.b	2				2				
1599		PG	Ecuelle/Jatte	LS PG E.2.7.b	1				1			VB16.1599.34	Pl. 7.6, n°60
1563		PG	Ecuelle/Jatte	LS PG E.2.7.c	2				2	Peigné			
1563		PG	Ecuelle/Jatte	LS PG E.2.7.c	1				1	Peigné		VB16.1563.25	Pl. 7.6, n°61
1599		PG	Ecuelle/Jatte	LS PG E.2.7.c	1				2			VB16.1599.35	Pl. 7.6, n°62
1808		PG	Pot	LS PG P.1.1.a	1				1	Peigné			
1599		PG	Pot	LS PG P.1.2.a	1				1				
1599		PG	Pot	LS PG P.1.2.a	1				1	Peigné		VB16.1599.36	Pl. 7.7, n°63
1808		PG	Pot	LS PG P.1.3.a	1				1			VB17.1808.12	Pl. 7.7, n°64
1599		PG	Pot	LS PG P.1.3.a	1				1	Peigné		VB16.1599.38	Pl. 7.7, n°65
1808		PG	Pot	LS PG P.1.3.a	1				1				
1599		PG	Pot	LS PG P.1.3.a	1				2				
1563		PG	Pot	LS PG P.1.3.b	1				1			VB16.1563.28	Pl. 7.7, n°66
1563		PG	Pot	LS PG P.1.3.b	1				1				
1656		PG	Pot	LS PG P.2.3	1				1			VB17.1656.04	Pl. 7.7, n°67
1563		PG	Pot	LS PG P.2.3	1				1			VB16.1563.23	Pl. 7.7, n°68

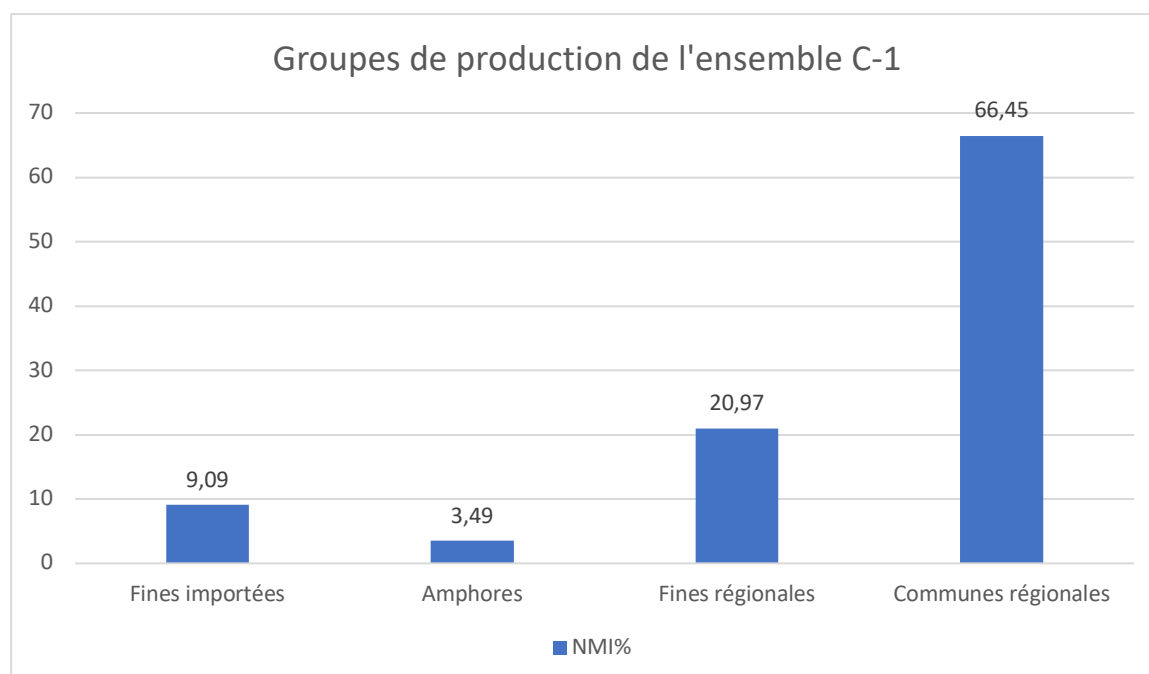
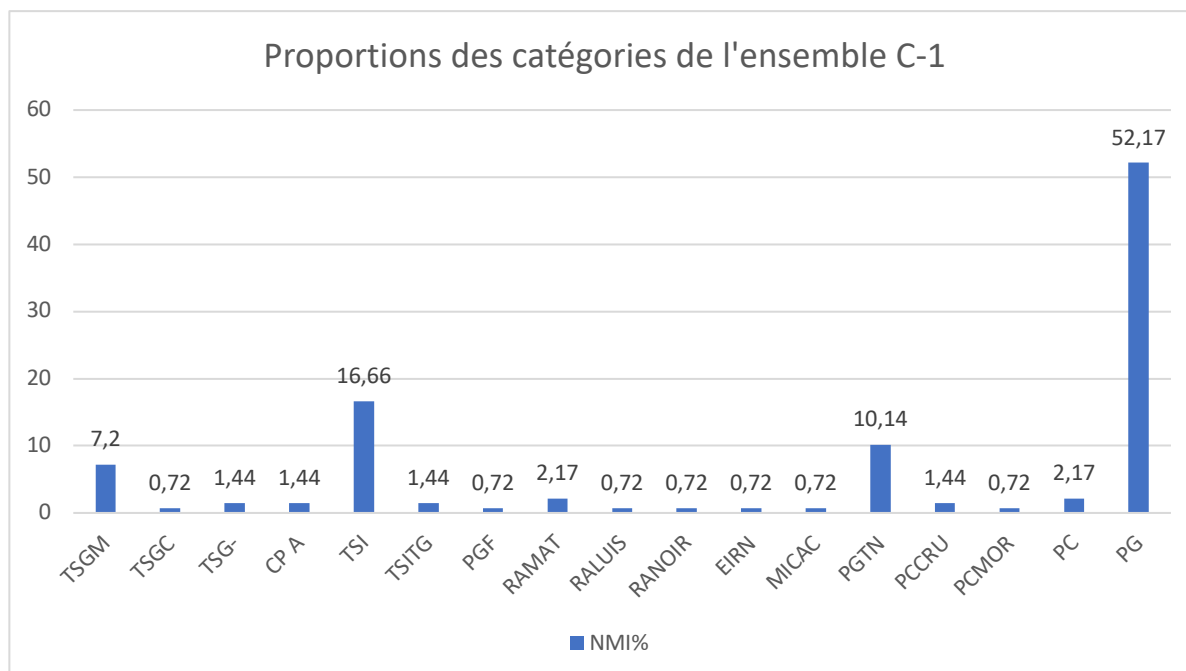
1599	PG	Pot	LS PG P.2.6	1					1				
1599	PG	Pot	LS PG P.2.9	2					4				
1563	PG	Pot	LS PG P.3.1	1					1				VB16.1563.29
1599	PG	Pot	LS PG P.3.3	1					1	Impressions carrées et triangles			VB16.1599.39
1808	PG	Pot	LS PG P.3.7.a	1					1				VB18.1808.04
1656	PG	Pot	LS PG P.3.7.a	1					1				
1599	PG	Pot	LS PG P.3.7.a.	1					2				VB16.1599.41
1808	PG	Couvercle	LS PG Cv.1.1	1					1	Impressions rectangles			
1808	PG	Couvercle	LS PG Cv.1.1	1					1				VB17.1808.17
1563	PG	Couvercle	LS PG Cv.1.1	1					1				
1808	PG	Couvercle	LS PG Cv.2.1	1					1				VB17.1808.16
1599	PG	Couvercle	LS PG Cv.2.1	3					4				
1599	PG	Couvercle	LS PG Cv.3.1	4					5				
1656	PG	Couvercle	LS PG Cv.3.2.a	1					1				VB16.1656.29
1563	PG	Couvercle	LS PG Cv.3.2.a	1					1				
1563	PG	Couvercle	LS PG Cv.3.2.a	1					1				VB16.1563.30
1599	PG	Couvercle	LS PG Cv.3.2.a	6					11				
1563	PG	Pot	indét.	5					5				
1599	PG	Pot	indét.	1	9				14				
1599	PG	Pot	indét.		1				1	Lignes lissées			
1808	PG	Pot	Indét.			1			1				
1656	PG	Pichet	indét.				1		1				
1656	PG	Dolium	indét.			1			1	Cordon de préhension			
1656	PG	Jeton			1				1				VB16.1656.12
1599	PG	Jeton			1				1				VB16.1599.18
1808	PG	Indét.		1	5	45			52				
1808	PG	Indét.				8			8	Peigné			
1808	PG	Indét.				1			1	Impressions rectangles			
1808	PG	Indét.			1				1	Lignes lissées			
1808	PG	Indét.				1			1	Cordon de préhension			
1656	PG	Indét.		3	3	52			55				
1656	PG	Indét.				11			11	Peigné			
1656	PG	Indét.				2			2	Lignes lissées			
1656	PG	Indét.				1			1	Impressions rectangles			
1806	PG	Indét.				2			2				
1563	PG	Indét.			6	39			45				
1563	PG	Indét.				1			1	Impressions triangles			
1563	PG	Indét.				15			15	Peigné			
1599	PG	Indét.				101			101				
1599	PG	Indét.				34			34	Peigné			
1599	PG	Indét.				17			17	Impressions rectangles			
1599	PG	Indét.				1			1	Impressions rectangles/triangles			
1599	PG	Indét.				1			1	Impressions digitées			
TOTAUX	233			219	64	757	5	9	1110				

Fig. 12.3: Tableau des amphores de l'ensemble D-3.

UF	NMI	Categorie	Type	Bord	Fond	Panse	Anse	Profil	NR	Décor	Commentaire	Inscription	Invetnaire	Illustration
1563	1	Bétique	Dressel 20			3			3					
1801	1	Gaule	indét.		1	5			6					
1808		Gaule	indét.			1			1					
1808		Gaule	indét.			1			1					
1656		Gaule	indét.			3	1		4					
1563		Gaule	indét.			9			9					
1656	1	Narbonnaise	Dressel 9 similis	1					1				VB16.1656.18	Pl. 7.8, n°77
1599	1		indét.			12			12					
1808			indét.			4			4					
1808			indét.			1			1					
1656			indét.			2			2					
1563			indét.		1	1			3					
TOTAUX	4			1	2	42	1		47					

3.2.8. Ensemble C-1 - Période C-1 (180 ap. J.-C.) (Pl. 8.1-8.6)

Fig. 13.1: Proportions choisies de l'ensemble C-1 (NMI exprimé en pourcents).



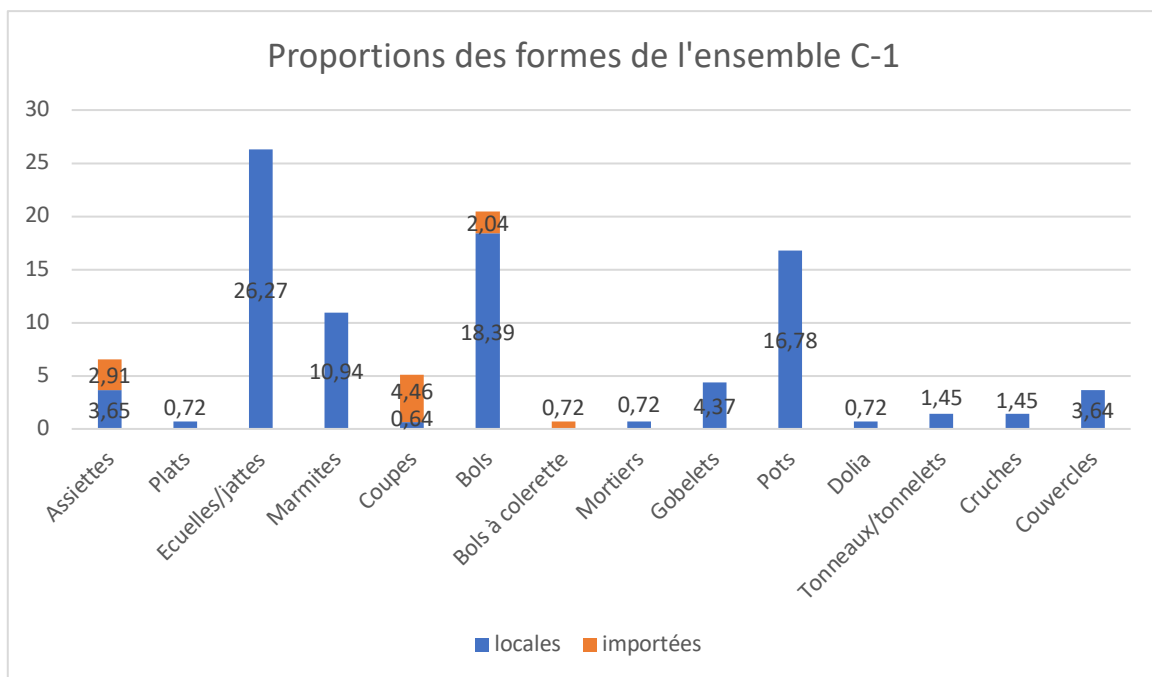
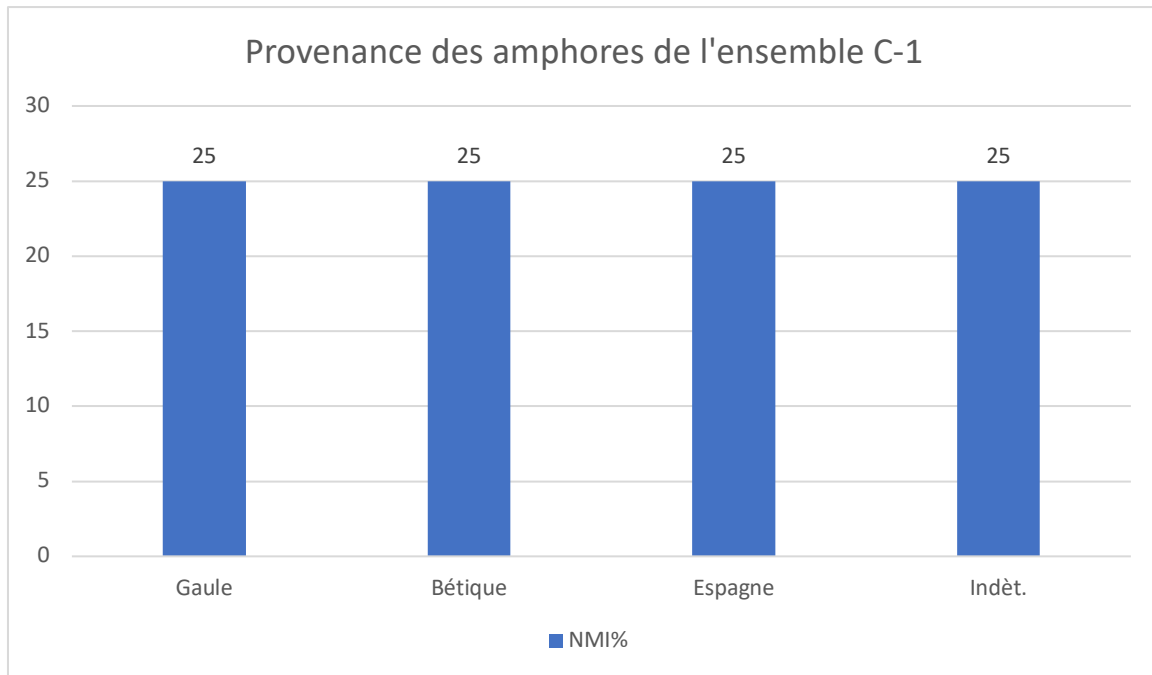


Fig. 13.2: Tableau des céramiques de l'ensemble C-1.

UF	NMI	Categorie	Forme	Type	Bord	Fond	Panse	Anse	Profil	NR	Décor	Commentaire	Inscription	Inventaire	Illustration
1042	10	TSGM	Assiette	Drag. 15/17			1			1					
1113		TSGM	Assiette	Drag. 15/17	1					1					
1118		TSGM	Assiette	Drag. 15/17	1					1					
1113		TSGM	Coupe	Drag. 27b	1					1				VB18.1113.09	Pl. 8.1, n°1
1042		TSGM	Coupe	Drag. 33	1					1				VB15.1042.07	Pl. 8.1, n°2
1048		TSGM	Coupe	Drag. 35	1					1	Feuille d'eau				
1042		TSGM	Coupe	Drag. 36	1					1				VB15.1042.06	Pl. 8.1, n°3
1113		TSGM	Coupe	Ritt. 8	1					1					
1117		TSGM	Bol	Drag. 29b	1		1			3					
1042		TSGM	Bol	Drag. 37		1				1			Estampille : OFGVLVI ?	VB17.1042.02	Pl. 8.1, n°6
1113		TSGM	Bol à colerette	Curle 11	1					1		colerette frag.		VB15.1113.01	Pl. 8.1, n°5
1197		TSGM	Coupe	indét.		1				1					
1042		TSGM	Indét.			1	3			4					
1113		TSGM	Indét.			1	7			8					
1118		TSGM	Indét.		1		1			2					
1042	1	TSGC	Coupe	Ha. 11	1					1	Guilloché			VB17.1042.01	Pl. 8.1, n°4
1113		TSGC	Indét.				2			2					
1117	2	TSG-	Assiette	Drag. 18	1					1					
1919		TSG-	Bol	Drag. 30			1			1					
1919	2	CP A	Bol	Paunier 11	1					1				VB17.1919.07	Pl. 8.1, n°7
1118		CP A	Bol	Paunier 11	1					1					
1042		CP A	Indét.				1			1					
1113		CP A	Indét.				3			4					
1117		CP A	Indét.				4			4					
1118	23	TSI	Assiette	Imit. Drag. 15/17, L7b	1					1				VB17.1919.06	Pl. 8.2, n°8
1113		TSI	Assiette	Imit. Drag. 15/17, L7	1					1					
1197		TSI	Assiette	Imit. Drag. 15/17, L7			1			1					
1113		TSI	Assiette	Imit. Ritt. 14B, L14	1					1				VB18.1113.10	Pl. 8.2, n°9
1046		TSI	Coupe	Imit. Drag. 35, L33	1					1				VB15.1046.03	Pl. 8.2, n°10
1042		TSI	Bol	Drack 21, L40c	3					3					
1048		TSI	Bol	Drack 21, L40c	1					1					
1042		TSI	Bol	Drack 21, L40c	1					1				VB15.1042.04	Pl. 8.2, n°11
1117		TSI	Bol	Drack 21, L40c	1					1				VB15.1117.07	Pl. 8.2, n°12
1117		TSI	Bol	Drack 21, L40c	1					1				VB15.1117.08	Pl. 8.2, n°13
1113		TSI	Bol	Drack 21, L40c	1					2					
1117		TSI	Bol	Drack 21, L40c	3					3					
1919		TSI	Bol	Drack 21, L40d	1					1					
1042		TSI	Bol	Drack 21, L40d	1					1				VB15.1042.05	Pl. 8.2, n°14
1113		TSI	Bol	Drack 21, L40d	5					5					
1919		TSI	Bol	Drack 21			3			3					
1046		TSI	Bol	Drack 21			3			3					
1113		TSI	Bol	Drack 21			1			1					
1042		TSI	Bol	L50			1			1					
1919		TSI	Indét.				8			8					
1042		TSI	Indét.			1	10			11					
1046		TSI	Indét.			1	3			4					
1113		TSI	Indét.			8	13			23					
1117		TSI	Indét.				6			6					

1919	2	TSITG	Assiette	Imit. Drag. 15/17, L7b	1				2				
1919		TSITG	Assiette	Imit. Drag. 15/17, L7	1		1		2				
1919		TSITG	Indét.		1				1				
1919	1	PGF	Tonneau/tonne	LS PG T.1.1.b	1				1	Lignes lissées			
1042	1	RAMAT	Gobelet	Indét.			2		2	Guilloché			
1042	1	RALUIS	Gobelet	Imit. Mayet 40	1				1			VB15.1042.03	Pl. 8.2, n°15
1919	1	RANOIR	Gobelet	indét.			1		1				
1117	1	EIRN	Plat	cf LS EIR A.2.4	1				1			VB15.1117.03	Pl. 8.2, n°16
1117	1	MICAC	Indét.				1		1				
1117		MICAC	Indét.				1		1	Guilloché			
1919	14	PGTN	Bol	AV 139	1		1		2				
1919		PGTN	Bol	AV 139	1				1			VB17.1919.13	Pl. 8.2, n°17
1046		PGTN	Bol	AV 139	1		4		6				
1046		PGTN	Gobelet	LS PG G.1.1	1				1	Impressions rectangles		VB15.1046.01	Pl. 8.3, n°18
1919		PGTN	Gobelet	HT			2		2	Barbotine points			
1048		PGTN	Gobelet	HT	1				1	Barbotine points		VB15.1048.01	Pl. 8.3, n°19
1919		PGTN	Pot	LS PG P.2.1	1				1			VB17.1919.12	Pl. 8.3, n°20
1113		PGTN	Pot	LS PG P.2.10	1				1			VB18.1113.13	Pl. 8.3, n°21
1113		PGTN	Pot	LS PG P.3.2	1				1				
1113		PGTN	Pot	LS PG P.3.7.b	1				1				
1117		PGTN	Pot	LS PG P.3.7	4				4				
1197		PGTN	Pot	indét.			1		1				
1919		PGTN	Tonneau/tonne	indét.		1			1				
1113		PGTN	Tonneau/tonne	Indét.			1		1				
1919		PGTN	Indét.				10		10				
1042		PGTN	Indét.				3		3				
1044		PGTN	Indét.				9		9				
1046		PGTN	Indét.				2		2				
1113		PGTN	Indét.				6		6				
1113		PGTN	Indét.				1		1	Godrons			
1113		PGTN	Indét.				1		1				
1113		PGTN	Indét.				1		1	Impressions rectangles/triangles			
1117		PGTN	Indét.				3		3				
1118		PGTN	Indét.				1		1				
1113	2	PCCRU	Cruche	LS CRU Cr.2.7	1				1			VB18.1113.16	Pl. 8.3, n°22
1117		PCCRU	Cruche	LS CRU Cr.3.3	1				3			VB15.1117.04	Pl. 8.3, n°23
1919		PCCRU	Cruche	indét.			28		28				
1042		PCCRU	Cruche	indét.		2	16		18				
1044		PCCRU	Cruche	indét.			22		22				
1046		PCCRU	Cruche	indét.			13		13				
1048		PCCRU	Cruche	indét.			5		5				
1113		PCCRU	Cruche	Indét.		3	62	1	67		dont 1 frgt avec poissage interne		
1117		PCCRU	Cruche	indét.		7	92	4	103				
1117		PCCRU	Cruche	indét.			1		1		graffito : [---]X[---]		
1113	1	PCMOR	Mortier	LS MOR Mo.3.6	1				1			VB18.1113.07	Pl. 8.3, n°24
1042		PCMOR	Mortier	indét.			1		1				
1113		PCMOR	Mortier	indét.			6		6				
1117		PCMOR	Mortier	indét.			1		1				

1046	3	PC	Ecuelle/Jatte	cf. LS PG E.1.6	1				1				VB15.1046.02	Pl. 8.3, n°25
1113		PC	Pot	LS PC P.1.9	1				1				VB18.1113.08	Pl. 8.3, n°26
1113		PC	Gobelet	cf. LS PG P.2.10	1				1				VB18.1113.17	Pl. 8.3, n°27
1042		PC	Indét.			1	6			7				
1046		PC	Indét.				4			4				
1113		PC	Indét.				9			9				
1117		PC	Indét.				5			5				
1197		PC	Indét.				1			1				
1919	72	PG	Ecuelle/Jatte	LS PG E.1.1.a					1	1				
1113		PG	Ecuelle/Jatte	LS PG E.1.1.a					1	1			VB18.1113.11	Pl. 8.3, n°28
1919		PG	Ecuelle/Jatte	LS PG E.1.1.a					1	1			VB17.1919.03	Pl. 8.3, n°29
1113		PG	Ecuelle/Jatte	LS PG E.1.1	1					1				
1113		PG	Ecuelle/Jatte	LS PG E.1.1					1	1	Lignes lissées			
1117		PG	Ecuelle/Jatte	LS PG E.1.1	1					1				
1919		PG	Ecuelle/Jatte	LS PG E.1.6.a	1					1			VB17.1919.08	Pl. 8.4, n°30
1042		PG	Ecuelle/Jatte	LS PG E.1.6.a	1					1				
1919		PG	Marmite tripod	LS PG Ma.1.7.a	2					2				
1919		PG	Marmite tripod	LS PG Ma.1.7.c	1					1				
1919		PG	Marmite tripod	LS PG Ma.1.7.c	1					1			VB17.1919.11	Pl. 8.4, n°31
1044		PG	Marmite tripod	LS PG Ma.1.7.c	2					3				
1046		PG	Marmite tripod	LS PG Ma.1.7.c	3					3				
1048		PG	Marmite tripod	LS PG Ma.1.7.c	1					1				
1113		PG	Marmite tripod	LS PG Ma.1.7.c	2					2				
1113		PG	Marmite tripod	LS PG Ma.1.7.c	2					2	Lignes lissées			
1197		PG	Marmite tripod	LS PG Ma.1.7.c	1					1				
1042		PG	Ecuelle/Jatte	LS PG E.2.1	1					1			VB15.1042.09	Pl. 8.4, n°32
1046		PG	Ecuelle/Jatte	LS PG E.2.2	1					1			VB15.1046.04	Pl. 8.4, n°33
1113		PG	Ecuelle/Jatte	LS PG E.2.5	1					1	Peigné			
1919		PG	Ecuelle/Jatte	LS PG E.2.7.a	1					2				
1919		PG	Ecuelle/Jatte	LS PG E.2.7.a	1					1			VB17.1919.09	Pl. 8.4, n°34
1042		PG	Ecuelle/Jatte	LS PG E.2.7.a	2					2				
1044		PG	Ecuelle/Jatte	LS PG E.2.7.a	2					2				
1046		PG	Ecuelle/Jatte	LS PG E.2.7.a	1					1				
1919		PG	Ecuelle/Jatte	LS PG E.2.7.b	1					1			VB17.1919.02	Pl. 8.4, n°35
1919		PG	Ecuelle/Jatte	LS PG E.2.7.b	2					2				
1044		PG	Ecuelle/Jatte	LS PG E.2.7.b	2					2				
1113		PG	Ecuelle/Jatte	LS PG E.2.7.b	1					1				
1919		PG	Ecuelle/Jatte	LS PG E.2.7.c	1					1			VB17.1919.10	Pl. 8.4, n°36
1113		PG	Ecuelle/Jatte	LS PG E.2.7.c	1					1			VB18.1113.12	Pl. 8.4, n°37
1042		PG	Ecuelle/Jatte	LS PG E.2.7.c	1					1				
1044		PG	Ecuelle/Jatte	LS PG E.2.7.c	2					3				
1113		PG	Ecuelle/Jatte	LS PG E.2.7.c	2					2				
1113		PG	Ecuelle/Jatte	LS PG E.2.7.c	1					1			VB18.1113.18	Pl. 8.5, n°38
1046		PG	Ecuelle/Jatte	LS PG E.2.7	1					1	Peigné			
1919		PG	Ecuelle/Jatte	LS PG E.5.2	1					1			VB17.1919.04	Pl. 8.5, n°39
1919		PG	Ecuelle/Jatte	AV 137	1					2				
1117		PG	Bol	LS PG B.5.2	1					1			VB15.1117.05	Pl. 8.5, n°40

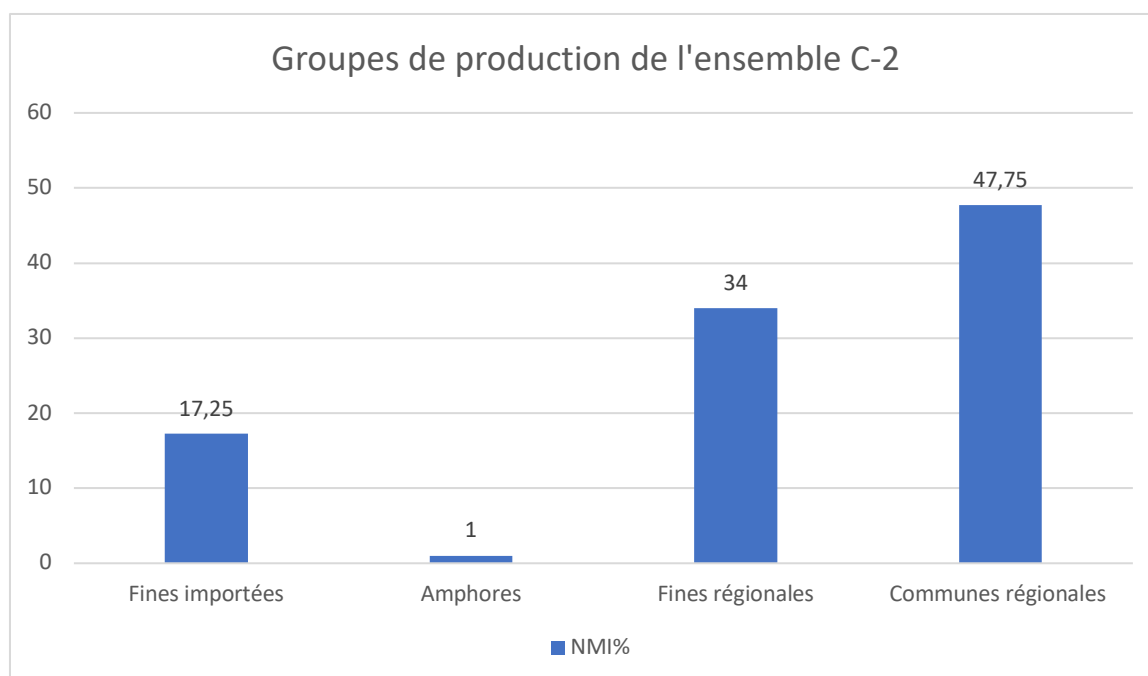
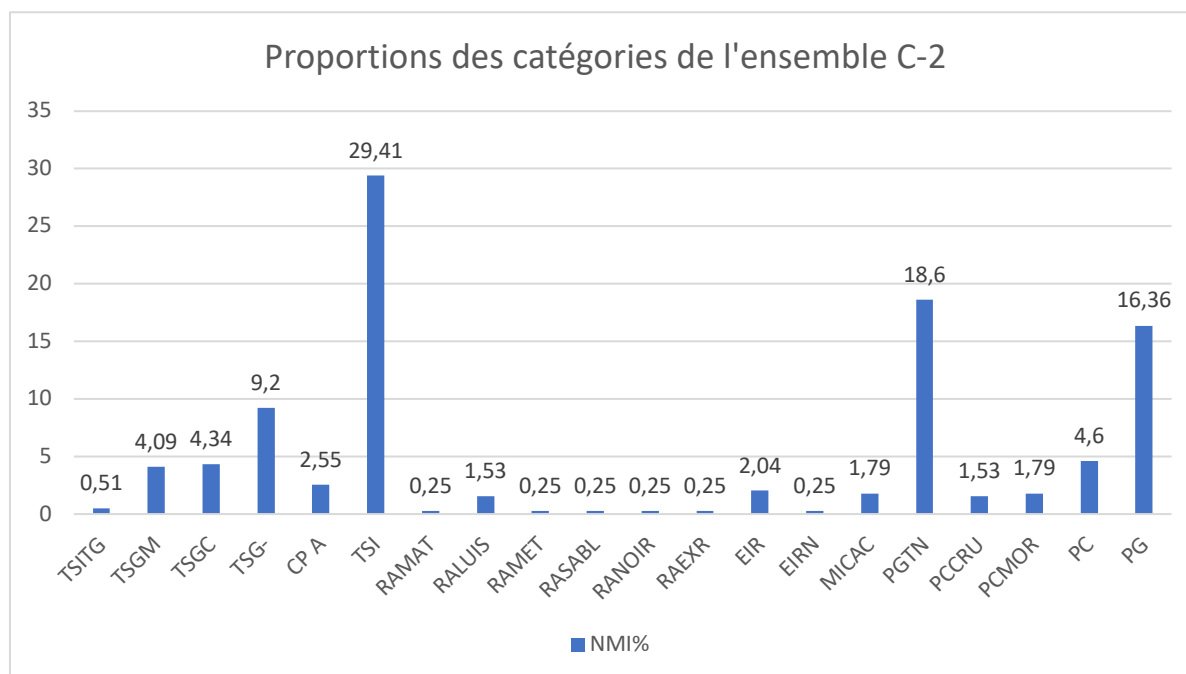
1919		PG	Pot	LS PG P.1.2.a	1					1				
1113		PG	Pot	LS PG P.1.3.a	1					1	Peigné			VB18.1113.20
1113		PG	Pot	LS PG P.1.3.a	1					1	Peigné			
1042		PG	Pot	LS PG P.1.3.b	1					2				VB15.1042.08
1046		PG	Pot	LS PG P.1.3.b	1					1				
1117		PG	Pot	LS PG P.1.6	1					1				VB15.1117.06
1042		PG	Pot	LS PG P.1.7	1					1				
1117		PG	Pot	LS PG P.2.2	1					1				VB15.1117.09
1113		PG	Pot	LS PG P.2.3	1					1				
1113		PG	Pot	LS PG P.3.1	1					1				VB18.1113.14
1113		PG	Pot	LS PG P.3.7.a	1					1				VB18.1113.15
1046		PG	Pot	LS PG P.3.7.b			1			1	Impressions rectangles			
1046		PG	Pot	LS PG P.3.7.b	1					1				VB15.1046.05
1042		PG	Pot	LS PG P.3.7	1					1				
1117		PG	Pot	LS PG P.3.7	1					1				
1113		PG	Dolium	LS PG D.1.1.b	1					1				
1113		PG	Couvercle	LS PG Cv.3.1	1					1				
1113		PG	Couvercle	LS PG Cv.3.1	1					1				VB18.1113.19
1919		PG	Couvercle	LS PG Cv.3.2.a	1					1				VB17.1919.05
1117		PG	Couvercle	LS PG Cv.3.2.a	2					2				
1044		PG	Pot	indét.			2			2	Impressions rectangles			
1113		PG	Pot	Indét.			1			1				
1042		PG	Pot	indét.		2				4				
1117		PG	Pot	indét.		2	28			31	Impressions rectangles et guillochis			
1117		PG	Pot	indét.	1					1				
1919		PG	Pichet	indét.				1		1				
1044		PG	FF				1			2			graffito [---]MIIN+[---]	VB15.1044.04
1919		PG	Indét.				4			4	Impressions rectangles			
1919		PG	Indét.				6			6	Peigné			
1919		PG	Indét.			5	5			10	Lignes lissées			
1919		PG	Indét.			6	57			63				
1919		PG	Indét.				4			4	Impressions rect. et lignes lissées			
1042		PG	Indét.			1	13			14				
1042		PG	Indét.				4			4	Peigné			
1042		PG	Indét.				2			2	Impressions rectangles			
1044		PG	Indét.			1	18			19				
1044		PG	Indét.				5			5	Peigné			
1046		PG	Indét.			3	14			17				
1046		PG	Indét.				3			3	Peigné			
1048		PG	Indét.				3			3				
1048		PG	Indét.				3			3	Peigné			
1113		PG	Indét.		1	2	31			34				
1113		PG	Indét.			1	2			3	Impressions rectangles			
1113		PG	Indét.				8			8	Peigné			
1113		PG	Indét.				1			1	Lignes lissées			
1113		PG	Indét.				1			1	Guilloché			
1117		PG	Indét.			3	19			22				
1118		PG	Indét.				1			1				
1197		PG	Indét.				1			1	Impressions rectangles			
1197		PG	Indét.				11			11				
TOTAUX	138				130	54	646	6	4	859				

Fig. 13.3: Tableau des amphores de l'ensemble

UF	NMI	Categorie	Type	Bord	Fond	Panse	Anse	Profil	NR	Décor	Commentaire	Inscription	Objet_inventorie	Illustration
1113	2	Gaule	Gauloise 4	1					1				VB19.1113.03	Pl. 8.7, n°50
1042		Gaule	Gauloise 4		1	2			3					
1044		Gaule	Gauloise 4			14			14					
1113		Gaule	Gauloise 4		1				1					
1042		Gaule	indét.			3			3					
1117		Gaule	indét.			2			2					
1113		Gaule	indét.			43			43					
1046		Gaule	indét.			6			6					
1118		Gaule	indét.			1			1					
1197		Gaule	indét.			2			2					
1117	1	Bétique	Dressel 20 ?	1					1				VB15.1117.02	Pl. 8.7, n°51
1044		Bétique	Dressel 20			2			2					
1046		Bétique	Dressel 20			1			1					
1113		Bétique	Dressel 20			1			1					
1117		Bétique	Dressel 20			2			2					
1117	1	Espagne	Beltran IIA	1					1				VB15.1117.01	Pl. 8.7, n°52
1044	1		indét.			2			2					
1046			indét.			1			1					
1113			indét.			6	1		7					
1117			indét.			3			3					
1118			indét.			1			1					
TOTAUX	5			3	2	92	1		98					

3.2.9. Ensemble C-2 - Période C-2 (180-200 ap. J.-C.) (Pl. 9.1-9.11)

Fig. 14.1: Proportions choisies de l'ensemble C-2 (NMI exprimé en pourcents).



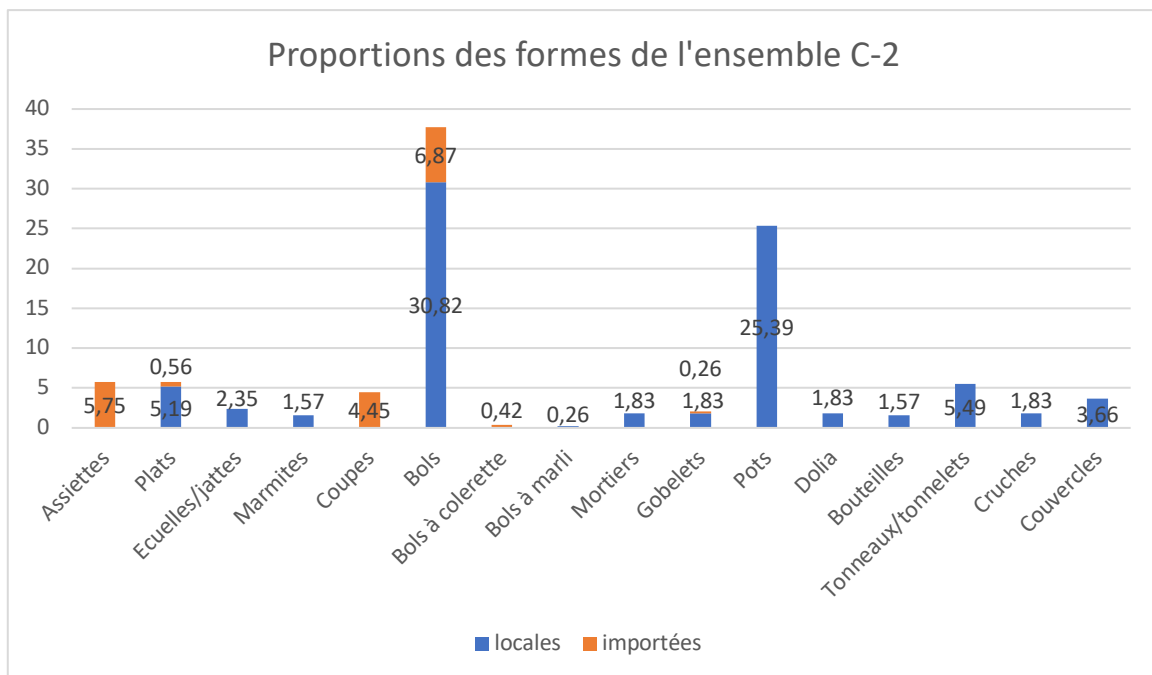
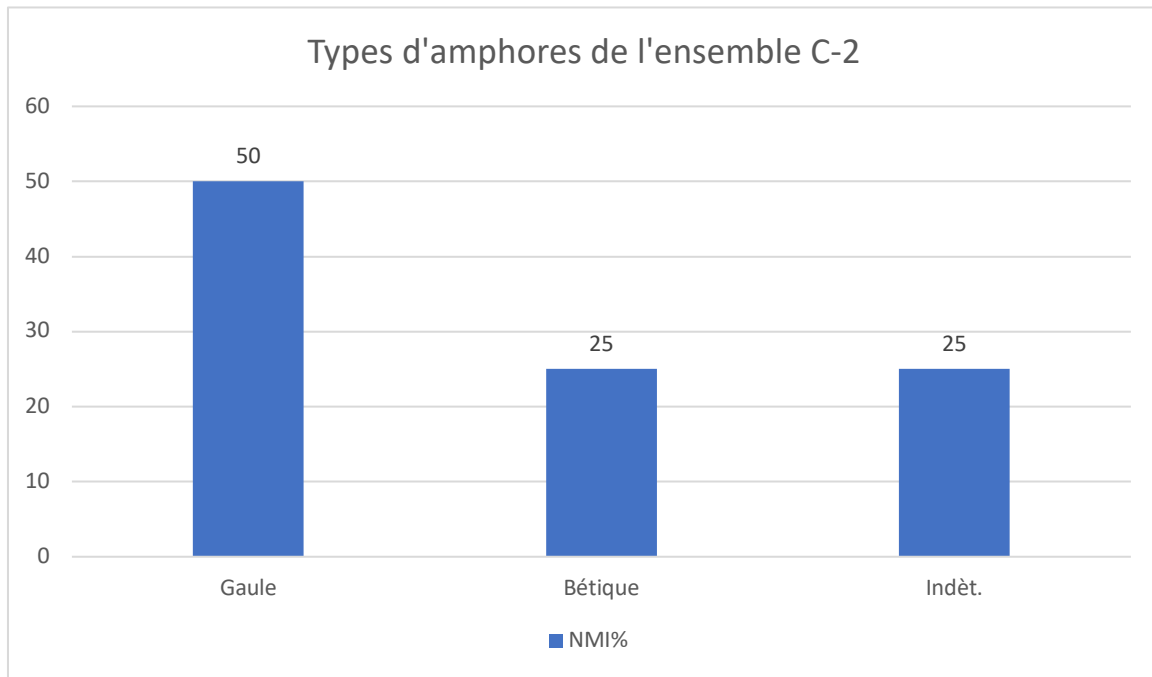


Fig. 14.2: Tableau des céramiques de l'ensemble C-2.

UF	NMI	Categorie	Forme	Type	Bord	Fond	Panse	Anse	Profil	NR	Décor	Commentaire	Inscription	Inventaire	Illustration
820	2	TSIT	Plat	Consp. 40/42.2	2					6				VB15.820.35	Pl. 9.1, n°1
820		TSIT	Indét.				1			1					
707	16	TSGM	Assiette	Drag. 36	6					6	Feuille d'eau				
707		TSGM	Assiette	Drag. 36	1					2	Feuille d'eau			VB15.707.42	Pl. 9.1, n°4
820		TSGM	Assiette	Ritt. 14b	1					1					
820		TSGM	Coupe	Drag. 33					1	9			Estampille: OF.L.COS.VIRI	VB15.820.10	Pl. 9.2, n°7
820		TSGM	Coupe	Drag. 33		1				1					
820		TSGM	Coupe	Ritt. 14b	2					3	Feuille d'eau				
820		TSGM	Coupe	Ritt. 14b	1					2	Feuille d'eau			VB15.820.79	Pl. 9.2, n°10
707		TSGM	Bol	Drag. 29				3		3					
820		TSGM	Bol	Drag. 37	1					1					
707		TSGM	Bol	Drag. 37	1		4			8					
707		TSGM	Bol	Drag. 37	1					1				VB15.707.43	Pl. 9.2, n°13
707		TSGM	Assiette	indét.		1				1					
820		TSGM	Assiette	indét.		1				1					
820		TSGM	Indét.				9			9					
707	17	TSGC	Assiette	Drag. 18/31	1	1				1		MAMMIUS, Lezoux, 155-18	Estampille MAMMI.O	VB14.707.02	Pl. 9.1, n°2
820		TSGC	Assiette	Drag. 36	1					1	Feuille d'eau				
820		TSGC	Assiette	Drag. 36	1					13	Feuille d'eau	feuilles d'eau en guirlande		VB15.820.43	Pl. 9.1, n°5
820		TSGC	Assiette	Herm. 29c	4					4					
820		TSGC	Coupe	Drag. 27	1					1			graffito : A ou V	VB15.820.48	Pl. 9.1, n°6
820		TSGC	Coupe	Drag. 35	3		1			4	Feuille d'eau				
820		TSGC	Coupe	Drag. 35	1					1	Feuille d'eau			VB15.820.100	Pl. 9.2, n°8
820		TSGC	Coupe	Hof. 10	1					1					
820		TSGC	Bol	Drag. 37			5			5		brûlée			
820		TSGC	Bol	Drag. 37	1					1				VB15.820.42	Pl. 9.2, n°15
707		TSGC	Bol	Drag. 37			1			1					
820		TSGC	Bol à colerette	Curle 11	1					4				VB15.820.73	Pl. 9.3, n°16
820		TSGC	Plat	indét.	1		7			10		brûlé			
820		TSGC	Gobelet	indét.			1			1					
820		TSGC	Indét.			1	4			5					
820	36	TSG-	Assiette	Herm. 29c	6					7		brûlé			
820		TSG-	Assiette	Herm. 29c	1					1		brûlé		VB15.820.102	Pl. 9.1, n°3
820		TSG-	Coupe	Curle 15	5					7		brûlé			
820		TSG-	Coupe	Curle 15	1					1		brûlé		VB15.820.97	Pl. 9.2, n°11
820		TSG-	Coupe	Herm. 28	1					2		brûlé		VB15.820.99	Pl. 9.2, n°9
820		TSG-	Bol	Drag. 29b	2	4	23			29		brûlé, coeur gris			
820		TSG-	Bol	Drag. 29		1				2			graffito : EMINAII ?	VB15.820.49	
820		TSG-	Bol	Drag. 37	17	2	23			43		brûlé			
820		TSG-	Bol	Drag. 37	1					1		brûlé		VB15.820.72	Pl. 9.2, n°14
820		TSG-	Bol	Drag. 29b	1					1		brûlé, coeur gris		VB15.820.101	Pl. 9.2, n°12
707		TSG-	Bol à colerette	Ritt. 12	1					1		Surcuit			
820		TSG-	Assiette	indét.		4				4		brûlé			
820		TSG-	Indét.				14			14		brûlé			
707		TSG-	Indét.			1	1			2		Surcuit			

707	10	CP A	Bol	Paunier 11	1				1					VB15.707.36	Pl. 9.3, n°17
820		CP A	Bol	HT	1				1					VB15.820.53	Pl. 9.3, n°18
820		CP A	Pot	LS CP P.1.3	1				1					VB15.820.11	Pl. 9.3, n°19
707		CP A	Pot	LS CP P.1.3	1				1					VB15.707.37	Pl. 9.3, n°20
820		CP A	Bouteille	Paunier 1	4	8			32						fd = tonneau AV 16 en PGTN ? brûlé
820		CP A	Bouteille	Paunier 1	1				1					VB15.820.31	Pl. 9.3, n°21
820		CP A	Bouteille	Paunier 1 ?	1				1						brûlé; CP A ?
820		CP A	Indét.				74		74						
707		CP A	Indét.				17		17						
820	115	TSI	Bol	Drack 20, L39	1				3					VB15.820.06	Pl. 9.3, n°22
820		TSI	Bol	Drack 20, L39	1				4						
820		TSI	Bol	Drack 21, L40a	1				1					VB15.820.76	Pl. 9.3, n°23
820		TSI	Bol	Drack 20, L39	1				2					VB15.820.80	Pl. 9.3, n°24
707		TSI	Bol	Drack 21, L40b	1				1					VB15.707.39	Pl. 9.3, n°25
820		TSI	Bol	Drack 21, L40c	71				71						
820		TSI	Bol	Drack 21, L40c	1				1					VB15.820.75	Pl. 9.4, n°26
707		TSI	Bol	Drack 21, L40c	1				1					VB15.707.41	Pl. 9.4, n°27
707		TSI	Bol	Drack 21, L40c	1				1					VB15.707.34	Pl. 9.4, n°28
707		TSI	Bol	Drack 21, L40c	1				1					VB15.707.40	Pl. 9.4, n°29
707		TSI	Bol	Drack 21, L40c	31		30		61						
707		TSI	Bol	Drack 21, L40d	1				1					VB15.707.35	Pl. 9.4, n°30
820		TSI	Bol	Drack 21, L40d	1				1					VB15.820.70	Pl. 9.4, n°31
820		TSI	Bol	Drack 21			47		47						
707		TSI	Bol	Drack 21	1		4		6						
707		TSI	Bol	lmit. Drag. 37, L45	1				1					VB15.707.47	Pl. 9.4, n°32
820		TSI	FF				1		2					graffito : [---]++++IANVS[---]	VB15.820.44
820		TSI	Indét.		1	38	359		398					nombreux tessons brûlés	
707		TSI	Indét.			12	94		106						
820	1	RAMAT	Indét.			1	17		18					brûlé; cat. incertaine (PEINT ou PC ?)	
707		RAMAT	Indét.			1			1					Surcuit, PCENGOB?	
707	6	RALUIS	Bol	Lamb. 2/37			1		1						
707		RALUIS	Gobelet	LS RA G.1.1	1				1						
707		RALUIS	Gobelet	LS RA G.1.3	1				1						
820		RALUIS	Gobelet	LS RA G.1.5	1				1					VB15.820.41	Pl. 9.4, n°33
707		RALUIS	Gobelet	LS RA G.1.6.b	1				1						
820		RALUIS	Gobelet	LS RA G.2.1	1				4					VB15.820.40	Pl. 9.4, n°35
820		RALUIS	Gobelet	indét.	1		3		4						
820		RALUIS	Gobelet	indét.			1		1					Guilloché	
707		RALUIS	Gobelet	indét.			4		4					Guilloché	
707		RALUIS	Gobelet	indét.			2		2					Cordons fendus	
820		RALUIS	Indét.			5	17		22						
820		RALUIS	Indét.				1		1					Barbotine points	
707		RALUIS	Indét.			7	28		35						
820	1	RAMET	Gobelet	indét.			2		2					Guilloché	
820		RAMET	Gobelet	indét.			3		5						
820		RAMET	Indét.				1		1					Barbotine animal	Avenches
820	1	RASABL	Gobelet	LS RA G.1.7.a	1				3					VB15.820.39	Pl. 9.4, n°34
820		RASABL	Gobelet	indét.			4		4						
707		RASABL	Indét.				9		9						
820	1	RANOIR	Indét.				3		3						
820	1	RAEXR	Indét.				1		1						

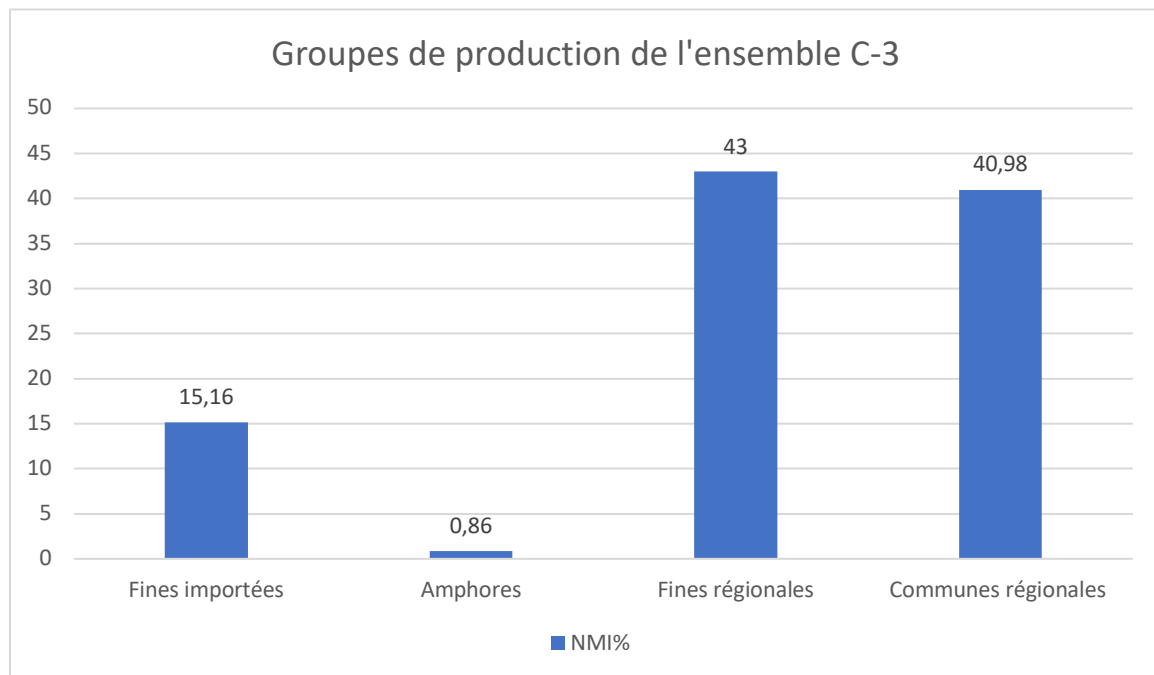
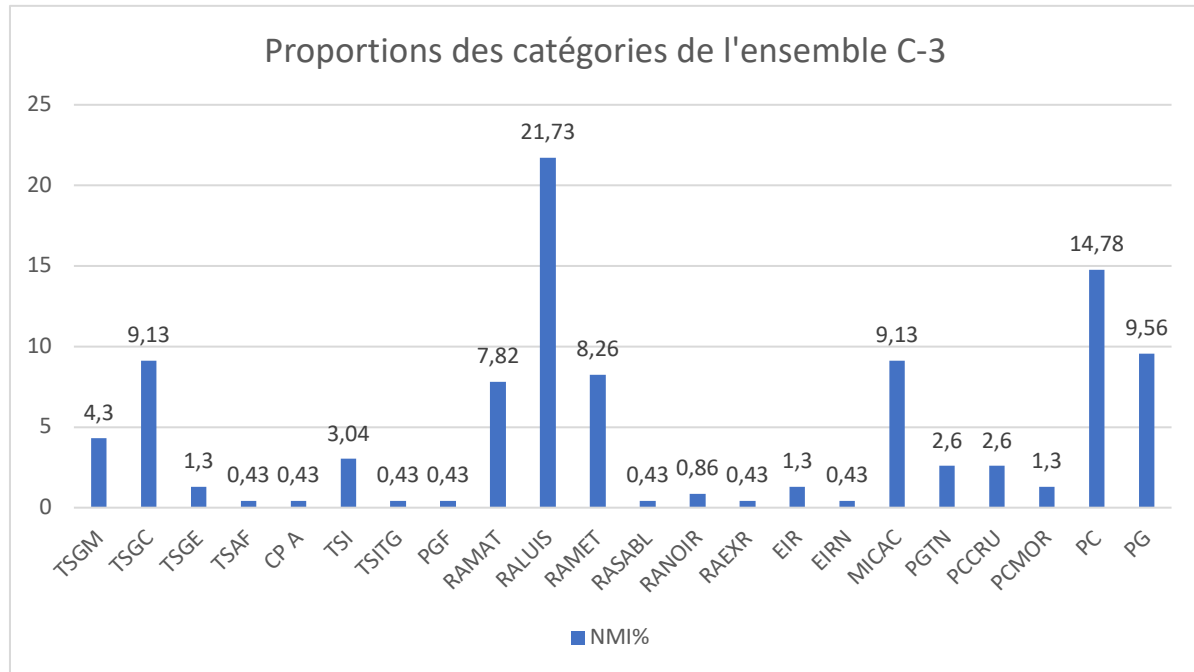
707	PG	Ecuelle/Jatte	LS PG E.2.7.b	1					1				VB15.707.53
707	PG	Ecuelle/Jatte	LS PG E.5.2	1					1		PG ?		VB15.707.49
820	PG	Pot	LS PG P.1.1.a	2					11				
707	PG	Pot	LS PG P.1.2.a	1					1				VB15.707.31
820	PG	Pot	LS PG P.1.2.b	4					5	Peigné			
820	PG	Pot	LS PG P.1.2.b	1					1	Peigné			VB15.820.65
820	PG	Pot	LS PG P.1.3.a	1					1	Peigné			
707	PG	Pot	LS PG P.1.3.b	1					1		PG ?		VB15.707.33
707	PG	Pot	LS PG P.1.3.b	6					6				
820	PG	Pot	LS PG P.1.3.b	5					6				
707	PG	Pot	LS PG P.1.5	1					1				
820	PG	Pot	LS PG P.1.6	1					2				
820	PG	Pot	LS PG P.1.6	1					1				VB15.820.69
820	PG	Pot	LS PG P.1.7	1					1				VB15.820.66
707	PG	Pot	LS PG P.2.3	1					1		PG ?		
707	PG	Pot	LS PG P.2.3	1					1		PG ?		VB15.707.52
820	PG	Pot	LS PG P.2.7	1					1				
707	PG	Pot	LS PG P.2.7	1					1				VB15.707.32
707	PG	Pot	LS PG P.3	1					1				
707	PG	Pot	LS PG P.3.2	1					1				
820	PG	Pot	cf AV 3/1	1					2				VB15.820.104
820	PG	Pot	cf AV 3/1	1					2				
820	PG	Pot	AV 47	1					1		pot à col cintré		
707	PG	Dolium	LS PG D.1.2.a	4					4				
707	PG	Dolium	LS PG D.1.2.a	1					1				VB15.707.50
820	PG	Dolium	LS PG D.1.2	1					2				
820	PG	Dolium	LS PG D.1.2	1					1				VB15.820.61
707	PG	Couvercle	LS PG Cv.1.1	1					1		PG ?		
820	PG	Couvercle	LS PG Cv.2.1	1					1				VB15.820.98
820	PG	Couvercle	LS PG Cv.3.2.a					1	1				VB15.820.64
820	PG	Couvercle	AV 391	2				1	3				VB15.820.09
707	PG	Couvercle	LS PG Cv.3.2.a	1					1				
820	PG	Couvercle	AV 387 (var.)	2					6		paroi légèrement convexe ! déformée.		
820	PG	Jeton			1				1		jeton découpé dans un fond de pot; brûlé		VB15.820.32
820	PG	Jeton			1				1		jeton découpé dans un fond de pot; brûlé, rouge		VB15.820.33
820	PG	Marmite tripode	indét.		8	1			9		brûlé ? certains frgt. assez beige !		
820	PG	Pot	Indét.	1					4				
820	PG	Pot	indét.	2					2				
820	PG	Pot	indét.			3			3	Impressions triangles			
820	PG	Dolium	indét.		4	164			169				
820	PG	Dolium	indét.			35			35	Peigné			
820	PG	Dolium	indét.			10			10	Cordon de préhension			
820	PG	Dolium	indét.			5			5	Cordon de préhension digité			
820	PG	Dolium	indét.			1			1	Cordon de préhension digité et ligne ondé			
820	PG	Dolium	indét.			3			3	Cordon de préhension digité	tessons rouge, brûlé		
820	PG	Dolium	indét.			7			13		graffiti : [--]+PXXXIII / PPCLXXXI		VB15.820.52
707	PG	Dolium	indét.			4			4	Cordon de préhension digité	PG ?		
820	PG	Couvercle	indét.		1				1		fond du Cv percé, entonnoir		VB15.820.38
820	PG	FF				1			1		déformé		
820	PG	Indét.			28	258			288		certaines brûlés avec cloques		
820	PG	Indét.				51			51	Peigné	certaines brûlés avec cloques		
820	PG	Indét.				16			16	Impressions rectangles	certaines brûlés avec cloques		
820	PG	Indét.			21	90			111		tessons rouge, brûlé		
820	PG	Indét.				88			88	Impressions rectangles	tessons rouge, brûlé		
820	PG	Indét.				55			55	Peigné	tessons rouge, brûlé		
820	PG	Indét.			1				1		fond de pot découpé, coupelle; brûlé		VB15.820.34
820	PG	Indét.				1			1		graffito illisible		VB15.820.46
820	PG	Indét.				1			1	Peigné			
707	PG	Indét.				27			27	Peigné			
707	PG	Indét.			14	248			277				
707	PG	Indét.				11			11	Impressions rectangles			
TOTAUX	391				388	212	2892	15	3	3732			

Fig. 14.3: Tableau des amphores de l'ensemble C-2.

UF	NMI	Categorie	Type	Bord	Fond	Panse	Anse	Profil	NR	Décor	Commentaire	Inscription	Inventaire	Illustration
707	2	Gaule	Gauloise 4			1			1					
820		Gaule	amphorisque			1			1					
820	1	Bétique	Dressel 20			1			1					
707	1		indét.			1			1					
820			indét.		1	7			8					
TOTAUX	4				1	11			12					

3.2.10 Ensemble C-3 - Période C-3 (274 ap. J.-C.) (Pl. 10.1-10.7)

Fig. 15.1: Proportions choisies de l'ensemble C-3 (NMI exprimé en pourcents).



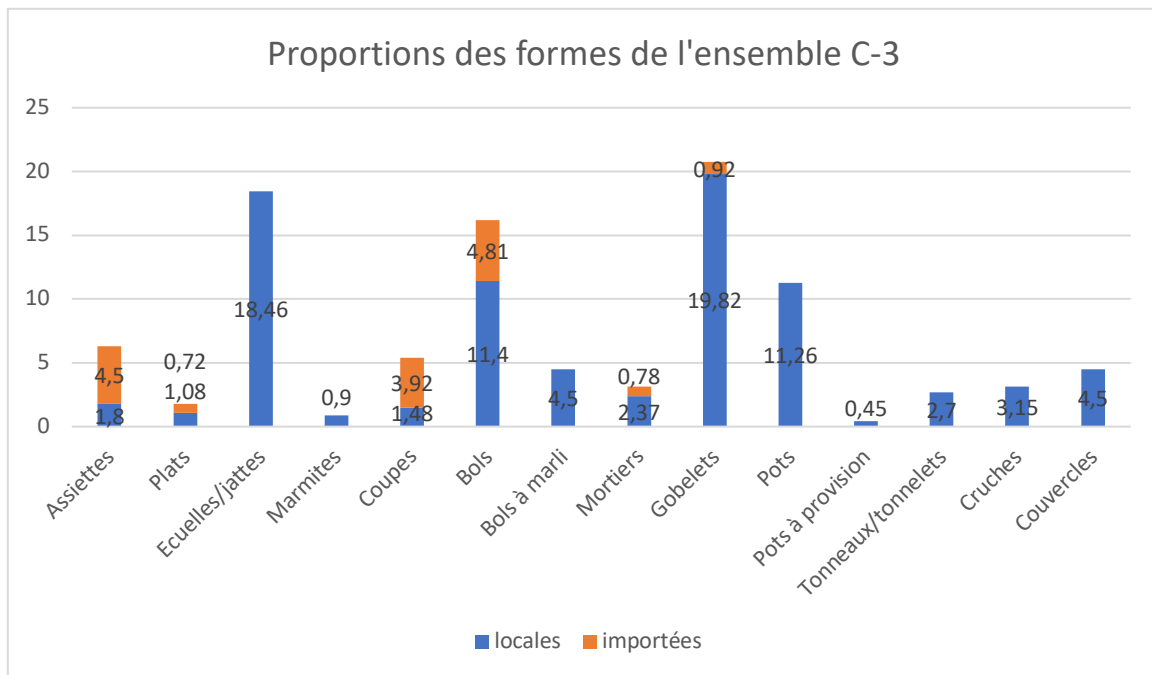
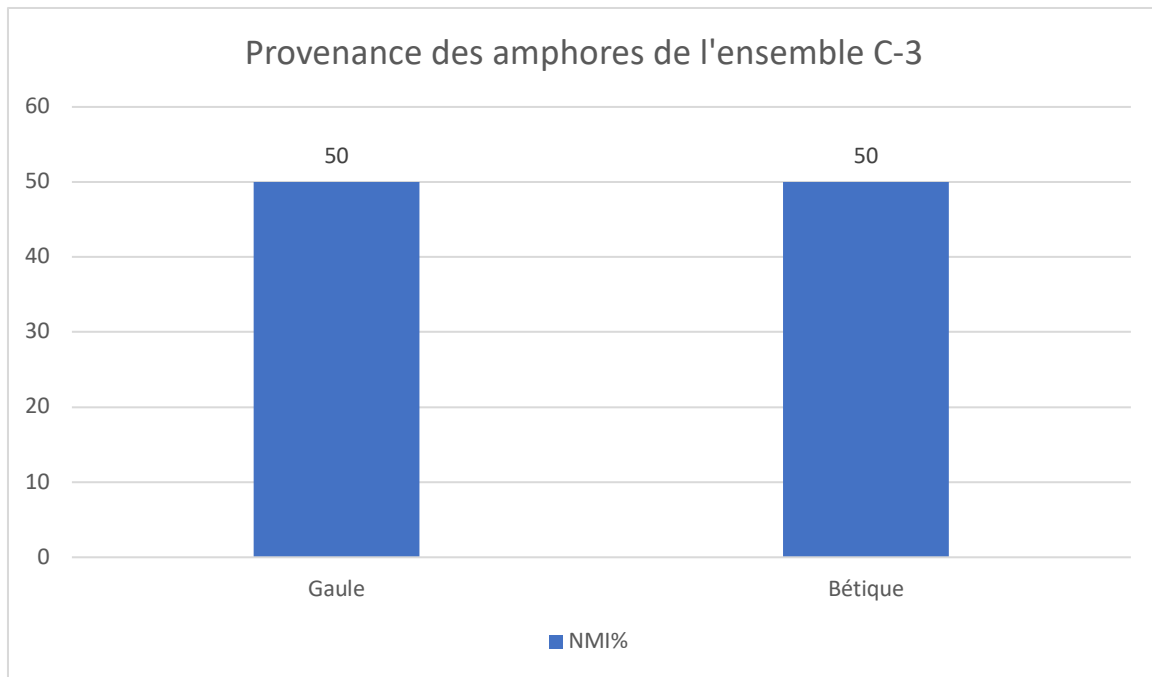


Fig. 15.2: Tableau des céramiques de l'ensemble C-3.

UF	NMI	Categorie	Forme	Type	Bord	Fond	Panse	Anse	Profil	NR	Décor	Commentaire	Inscription	Inventaire	Illustration
705	10	TSGM	Assiette	Drag. 36			1			1					
705		TSGM	Assiette	Curle 15	1					1					
705		TSGM	Coupe	Drag. 27			2			2					
705		TSGM	Coupe	Drag. 35	1					1	Feuille d'eau			VB14.705.73	Pl. 10.1, n°5
705		TSGM	Coupe	Drag. 35	2					2					
705		TSGM	Bol	Drag. 29			4			4				VB14.705.06	
705		TSGM	Bol	Drag. 37	1					1	Décor d'applique				
705		TSGM	Bol	Drag. 37	1		2			3	Brulé				
705		TSGM	Gobelet	Indét.			4			4	Excisé				
705		TSGM	Indét.				6			6					
705	21	TSGC	Plat	Drag. 31 (Lz 57, phase I)	2					2					
705		TSGC	Assiette	Drag. 31	3					3					
705		TSGC	Assiette	Drag. 36	1					1					
705		TSGC	Assiette	Le 032A	1					1					
705		TSGC	Assiette	Le 032P					1	2				VB14.705.25	Pl. 10.1, n°3
705		TSGC	Coupe	Drag. 33A	1					1				VB14.705.99	Pl. 10.1, n°4
705		TSGC	Coupe	Drag. 33	2					2					
705		TSGC	Bol	Drag. 37	2		3			5					
705		TSGC	Bol	Drag. 37	2		5			9					
705		TSGC	Bol	Drag. 37	1					1				VB14.705.67	Pl. 10.1, n°8
705		TSGC	Bol	Drag. 37	1					1				VB14.705.97	Pl. 10.1, n°9
705		TSGC	Bol	Le 003	1					1					
705		TSGC	Mortier	Drag. 45	1					1		Tête de lion		VB14.705.02	Pl. 10.2, n°11
705		TSGC	Mortier	Drag. 45	1					2				VB14.705.24	Pl. 10.2, n°10
705		TSGC	Gobelet	Déchelette 72	1					1				VB15.705.54	Pl. 10.1, n°7
705		TSGC	Indét.				1			1	Barbotine				
705		TSGC	Indét.				13			13					
705	3	TSGE	Assiette	Drag. 18/31		1				1		Hartley et Dick	Estampille OC- IS	VB14.705.03	Pl. 10.1, n°1
705		TSGE	Assiette	Drag. 31					1	6				VB14.705.36	Pl. 10.1, n°2
705		TSGE	Assiette	Indét.		1				5					
705		TSGE	Bol	Indét.			4			4					
705		TSGE	Indét.				5			5					
705	1	TSAF	Coupe	Hayes 9a	1					1		Ref. Lattara 6, p. 172, Claire A af		VB14.705.29	Pl. 10.1, n°6
705		TSAF	Indét.			2				2				VB14.705.30	
705	1	CP A	Bol	Paunier 11 ?			11			11	Bandeau blanc/lie de vin				
705		CP A	Indét.				12			12	Bandeau blanc/lie de vin				
705	7	TSI	Assiette	Imit. Drag. 18, L6	2				1	3					
705		TSI	Coupe	Imit. Drag. 27, L30	1					3				VB15.705.12	Pl. 10.2, n°12
705		TSI	Coupe	Imit. Drag. 27, L30			2			2					
705		TSI	Coupe	Imit. Drag. 35, L33	1					1					
705		TSI	Bol	Drack 21, L40c	2					2					
705		TSI	Bol	Drack 21, L40c	1					1				VB14.705.76	Pl. 10.2, n°13
705		TSI	Bol	Drack 21			4			4					
705		TSI	Bol	Drack 21			1			1			graffito : XA à l'ir	VB15.705.14	
705		TSI	Indét.				32			32					
705	1	TSITG	Indét.				1			1					
705	1	PGF	Indét.				2			2					

705	50	RALUIS	Assiette	Imit. Drag. 16	1				1		Points de chaux, surcuit, raté	VB14.705.40
705		RALUIS	Ecuelle/Jatte	LS RA E.2.2				1	2			VB14.705.27
705		RALUIS	Ecuelle/Jatte	LS RA E.2.2				1	3			
705		RALUIS	Bol	LS RA B.2.1.c	1				1			
705		RALUIS	Bol	Imit. Drag. 30	1				1			
705		RALUIS	Bol	Imit. Drag. 30			3		3			
705		RALUIS	Bol	Lamb. 2/37	12				2			
705		RALUIS	Bol	Lamb. 2/37			6		6	Occulé		
705		RALUIS	Bol	Lamb. 2/37	1				1	impression d'une étoile inscrit dans un carré		VB15.705.55
705		RALUIS	Bol à marli	LS RA B.2.4	1				1			
705		RALUIS	Gobelet	LS RA G.1.4	1		1		2			VB14.705.10
705		RALUIS	Gobelet	LS RA G.1.5	1				3	Guilloché		
705		RALUIS	Gobelet	LS RA G.1.5	1				1	Cordons fendus		VB14.705.95
705		RALUIS	Gobelet	LS RA G.1.5	1				1			
705		RALUIS	Gobelet	LS RA G.1.5	1				1			
705		RALUIS	Gobelet	LS RA G.1.6	2				2			
705		RALUIS	Gobelet	LS RA G.1.7.a	1				1			VB14.705.71
705		RALUIS	Gobelet	LS RA G.1.7.a	1				1	Damier à la molette		VB15.705.50
705		RALUIS	Gobelet	LS RA G.1.7.a	1				1	Cordons fendus croisés		VB15.705.51
705		RALUIS	Gobelet	LS RA G.1.7.a	1				1			VB14.705.96
705		RALUIS	Gobelet	LS RA G.1.7.a	1				1	Guilloché		VB14.705.93
705		RALUIS	Gobelet	LS RA G.1.7.a (var.)	1				2	Sablé		VB15.705.53
705		RALUIS	Gobelet	LS RA G.2.1	2				3			
705		RALUIS	Gobelet	LS RA G.2.1	1				1	Guilloché		
705		RALUIS	Gobelet	LS RA G.2.1	1				1	Sablé		
705		RALUIS	Gobelet	LS RA G.2.3.a	1				2			VB14.705.84
705		RALUIS	Gobelet	LS RA G.2.3.b	1				1			VB14.705.85
705		RALUIS	Gobelet	LS RA G.2.3.b	1				1			VB14.705.69
705		RALUIS	Gobelet	LS RA G.2.3.b	1				1			VB14.705.78
705		RALUIS	Gobelet	LS RA G.2.4	1		1		2			VB14.705.34
705		RALUIS	Gobelet	LS RA G.3.2	1				1	Guilloché		VB14.705.72
705		RALUIS	Gobelet	Nied. 32	1				1			VB14.705.100
705		RALUIS	Gobelet	Nied. 33			1		1	Dépression, guilloché		
705		RALUIS	Gobelet	AV 10/2	1				4			VB14.705.11
705		RALUIS	Gobelet	AV 49	1				1	Guilloché		VB15.705.52
705		RALUIS	Cruche	cf AV 345	1	1			3			VB15.705.15
705		RALUIS	Jeton				1		1			
705		RALUIS	Bol	Indét.		1			1			
705		RALUIS	Mortier	Indét.			1		1			
705		RALUIS	Gobelet	Indét.			192		192	Guilloché		
705		RALUIS	Gobelet	Indét.		9	126		134			
705		RALUIS	Gobelet	Indét.			31		31	Cordons fendus		
705		RALUIS	Gobelet	Indét.			32		32			
705		RALUIS	Gobelet	Indét.		3			3			
705		RALUIS	Gobelet	Indét.			2		2	Barbotine		
705		RALUIS	Gobelet	Indét.			4		4	Occulé		
705		RALUIS	Gobelet	Indét.			2		2	Cannelures		
705		RALUIS	Gobelet	Indét.			1		1	Triangles à la molette		
705		RALUIS	Gobelet	indét.			4		4	Cordons fendus croisés et cercles		
705		RALUIS	Gobelet	indét.			2		2	Cordons fendus et points		
705		RALUIS	Gobelet	indét.			1		1	Barbotine animal et points		VB15.705.56
705		RALUIS	Pot	Indét.		1			1			
705		RALUIS	Cruche	Indét.			1		1			
705		RALUIS	Indét.				2		2		Graffite QU...	VB14.705.09
705		RALUIS	Indét.				3		3	Damier à la molette	Avenches	
705		RALUIS	Indét.		1	4	106		111			
705		RALUIS	Indét.				2		2	Barbotine points		

705	19	RAMET	Bol	Lamb. 2/37		1				1				
705		RAMET	Bol	Imit. Drag. 30				1		1		Points de chaux, raté	VB14.705.39	
705		RAMET	Mortier	Imit. Drag. 43, LS RA Mo.3.2				6		6			VB14.705.26	
705		RAMET	Gobelet	LS RA G.1.4		1				1	Guilloché		VB14.705.01	Pl. 10.3, n°23
705		RAMET	Gobelet	LS RA G.1.4		1				2			VB14.705.28	Pl. 10.3, n°24
705		RAMET	Gobelet	LS RA G.1.7.a		1				1	Guilloché			
705		RAMET	Gobelet	LS RA G.1.7.a		1				1	Cordons fendus croisés		VB15.705.46	Pl. 10.4, n°31
705		RAMET	Gobelet	LS RA G.1.7.a		1				1	Guilloché		VB15.705.45	Pl. 10.4, n°32
705		RAMET	Gobelet	LS RA G.2.1		1				2				
705		RAMET	Gobelet	LS RA G.2.1 (var.)		1				1	Guilloché		VB15.705.48	Pl. 10.4, n°34
705		RAMET	Gobelet	LS RA G.2.3.a		1				1			VB15.705.49	Pl. 10.4, n°36
705		RAMET	Gobelet	LS RA G.2.3.a		1				1				
705		RAMET	Gobelet	LS RA G.2.3.b		1				1			VB15.705.47	Pl. 10.4, n°40
705		RAMET	Gobelet	cf LS RA G.2.7		1				1				
705		RAMET	Ecuelle/Jatte	indét.		3	1			4				
705		RAMET	Gobelet	Indét.				4		4	Cordons fendus	Surcuit, raté	VB14.705.41	Pl. 10.4, n°42
705		RAMET	Gobelet	Indét.				16		16	Guilloché			
705		RAMET	Gobelet	Indét.				2		2	Barbotine			
705		RAMET	Gobelet	Indét.		2	4	13		19				
705		RAMET	Gobelet	indét.				5		5	Cordons fendus croisés			
705		RAMET	Cruche	Indét.				8		8		Avenches, personnage à la barbe	VB14.705.08	
705		RAMET	Cruche	Indét.				2		2				
705		RAMET	Indét.			5		55		60				
705		RAMET	Indét.					43		43	Guilloché			
705		RAMET	Indét.					2		2	Barbotine animal			
705	1	RASABL	Gobelet	indét.			1	3		4				
705		RASABL	Indét.					3		3				
705	2	RANOIR	Bol	Lamb. 2/37		1				5			VB14.705.35	Pl. 10.3, n°19
705		RANOIR	Bol	Lamb. 2/37				4		4	Occulé			
705		RANOIR	Gobelet	Indét.			3	3		5				
705		RANOIR	Indét.					4		4	Guilloché			
705	1	RAEXR	Gobelet	indét.				3		3				
705	18	RAMAT	Ecuelle/Jatte	LS RA E.2.2		1				1			VB14.705.87	Pl. 10.3, n°16
705		RAMAT	Ecuelle/Jatte	LS RA E.2.2		1			1	1	Collerette		VB14.705.104	Pl. 10.3, n°17
705		RAMAT	Ecuelle/Jatte	LS RA E.2.2		3			1	4	Collerette			
705		RAMAT	Bol à marli	LS RA B.2.4		6				6				
705		RAMAT	Bol à marli	LS RA B.2.4		1				1			VB14.705.70	Pl. 10.3, n°20
705		RAMAT	Mortier	Imit. Drag. 43, LS RA Mo.3.2				1		1	Collerette			
705		RAMAT	Gobelet	LS RA G.1.4		1				2				
705		RAMAT	Gobelet	LS RA G.1.4		1				1			VB14.705.92	Pl. 10.3, n°21
705		RAMAT	Pot	cf LS PC P.1.10		1				1				
705		RAMAT	Pot	cf LS PC P.2.1		1				1				
705		RAMAT	Ecuelle/Jatte	Indét.			3			5				
705		RAMAT	Mortier	Indét.			2	1		3	Collerette			
705		RAMAT	Gobelet	Indét.				5		5	Sablé			
705		RAMAT	Pot	Indét.		1				1				
705		RAMAT	Cruche	Indét.				1		1				
705		RAMAT	Indét.				1	22		23				

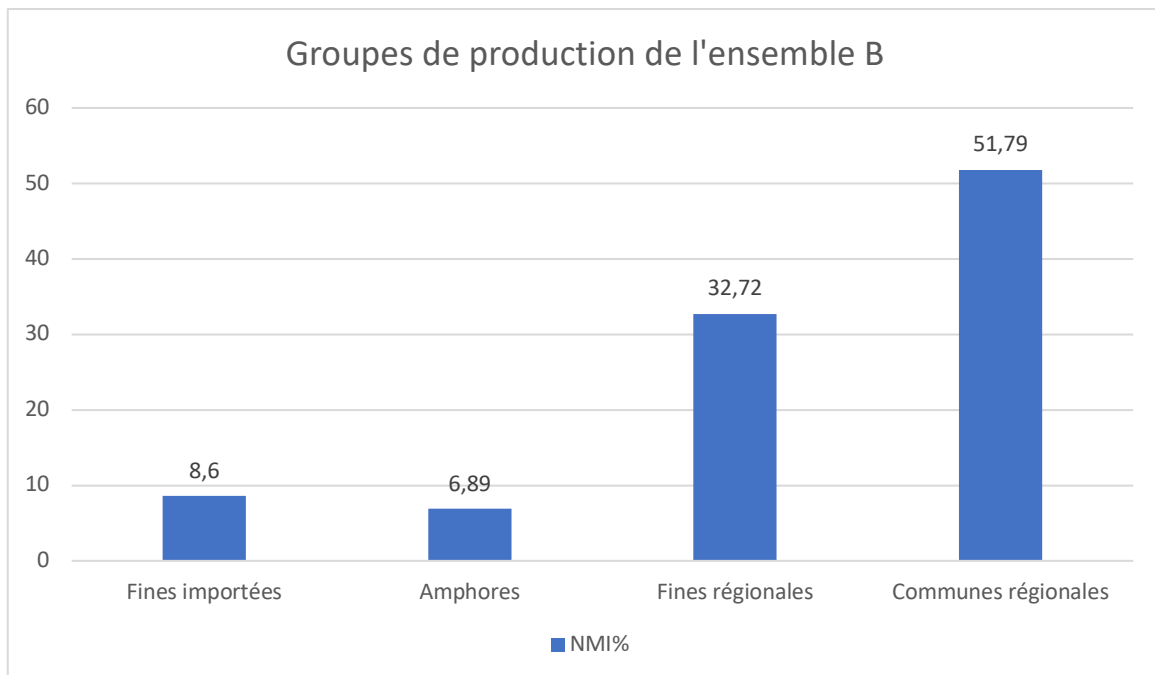
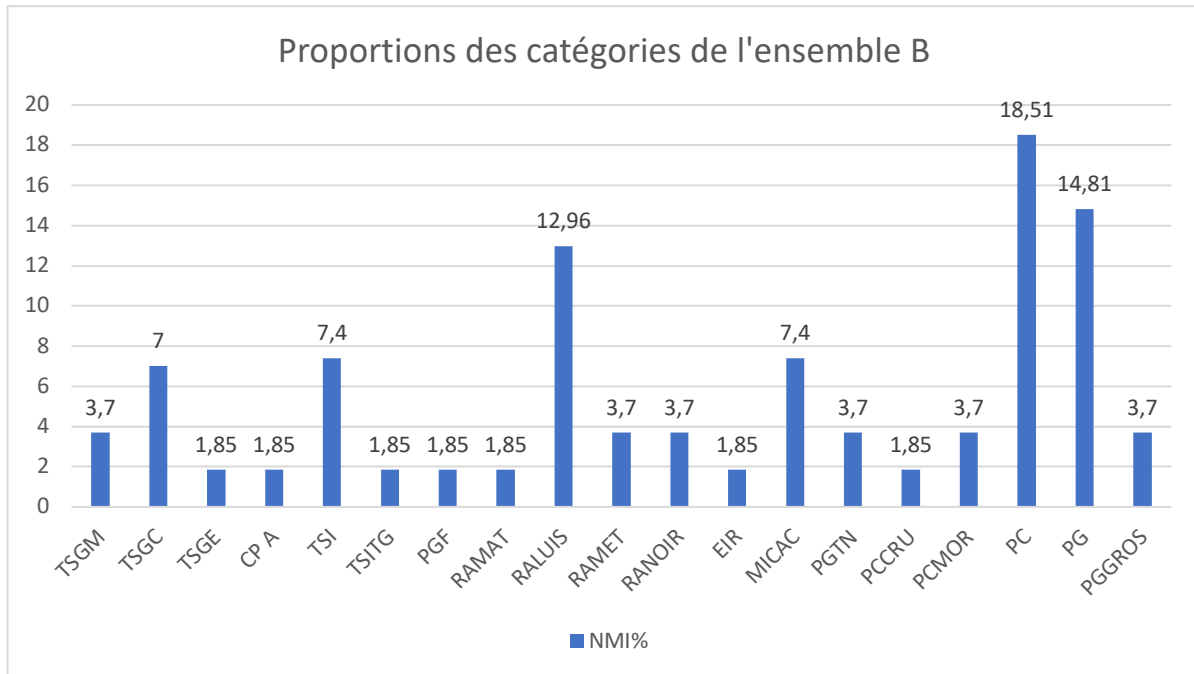
705	34	PC	Ecuelle/Jatte	LS PC E.2.1	11				11					
705		PC	Ecuelle/Jatte	LS PC E.2.1	1				1					
705		PC	Ecuelle/Jatte	LS PC E.2.2	1				1					
705		PC	Ecuelle/Jatte	LS PC E.2.2	1				1				VB14.705.81	Pl. 10.6, n°59
705		PC	Ecuelle/Jatte	LS PC E.2.3.b	1				1					
705		PC	Ecuelle/Jatte	LS PC E.2.3.b	1				2					
705		PC	Ecuelle/Jatte	cf LS PG E.2.7.a	1				1					
705		PC	Bol	LS PC B.2.7	1				1					
705		PC	Bol à marli	cf LS PC B.2.5	1				1					
705		PC	Pot	LS PC P.1.6	1				1		Surcuit		VB14.705.79	Pl. 10.6, n°60
705		PC	Pot	cf LS PG P.1.7	1				1				VB14.705.77	Pl. 10.6, n°61
705		PC	Pot	LS PC P.2.1	3				7					
705		PC	Pot	LS PC P.2.2	1				1		Impressions rectangl		VB14.705.80	Pl. 10.6, n°62
705		PC	Pot	AV 42	1									
705		PC	Couvercle	LS PC Cv.2.2	1				2					
705		PC	Couvercle	cf LS PC Cv.2.2	1				1		Surcuit		VB14.705.23	Pl. 10.6, n°63
705		PC	Couvercle	LS PC Cv.2.2	4				4					
705		PC	Couvercle	AV 389	1				1				VB14.705.98	Pl. 10.6, n°64
705		PC	Pot	Indét.		10	58		68					
705		PC	Pot	indét.	5				5					
705		PC	Pot à provision	Indét.				1	1					
705		PC	Indét.		1	9	203		213		1 pn brûlée			
705		PC	Indét.		1	4	60		65		Frag.			
705		PC	Indét.			2	51		53					
705	22	PG	Marmite tripod	LS PG Ma.1.7.c	1				1				VB14.705.74	Pl. 10.6, n°65
705		PG	Marmite tripod	LS PG Ma.1.7.c	1				1					
705		PG	Ecuelle/Jatte	LS PG E.2.2	1				1				VB14.705.94	Pl. 10.6, n°66
705		PG	Ecuelle/Jatte	LS PG E.2.2	1				1					
705		PG	Ecuelle/Jatte	LS PG E.2.7	1				1					
705		PG	Pot	LS PG P.1.3.b	1				1				VB14.705.75	Pl. 10.7, n°67
705		PG	Pot	LS PG P.2.2	1				1				VB14.705.89	Pl. 10.7, n°68
705		PG	Pot	LS PG P.2.3	1				2				VB14.705.68	Pl. 10.7, n°69
705		PG	Pot	LS PG P.2.12	1				1					
705		PG	Pot	LS PG P.2.6	1				1				VB14.705.103	Pl. 10.7, n°70
705		PG	Pot	LS PG P.3.2	1				1					
705		PG	Pot	LS PG P.3.6	1				1					
705		PG	Pot	LS PG P.3.6 (var.)	1				1					
705		PG	Pot	LS PG P.3.7	1				1					
705		PG	Pot	LS PG P.3.7	1				1					
705		PG	Tonneau/tonne	LS PG T.1.3	1				1					
705		PG	Tonneau/tonne	LS PG T.1.3	2				2		Impressions carrées			
705		PG	Tonneau/tonne	LS PG T.1.3 (var.)	1				1					
705		PG	Couvercle	cf LS PC Cv.2.2	2				2					
705		PG	Couvercle	LS PG Cv.3.2.a	1				1					
705		PG	Pot	Indét.	2	5			7					
705		PG	Pot	Indét.			1		1		Godrons			
705		PG	Pot	indét.	1				1					
705		PG	Pot	indét.	1				1					
705		PG	Pot	Indét.			2		2		Cordon de préhension digité			
705		PG	Pot	Indét.			12		12		Peigné			
705		PG	Pot	Indét.			1		1		Impressions carrées			
705		PG	Couvercle	Indét.		2			2					
705		PG	Indét.		2		143		145					
705		PG	Indét.				2		2		Guilloché			
TOTAUX	230				222	127	1530	4	11	1929				

Fig. 15.3: Tableau des amphores de l'ensemble C-3.

UF	NMI	Categorie	Type	Bord	Fond	Panse	Anse	Profil	NR	Décor	Commentaire	Inscription	Inventaire	Illustration
705	1	Gaule	amphorisque		1				3					
705		Gaule	Indét.		1	23			24					
705		Gaule	indét.			2			2					
705	1	Bétique	Dressel 20			6			6					
TOTAUX	2				2	31			35					

3.2.11. Ensemble B - Période B (330) (Pl. 11.1-11.4)

Fig. 16.1: Proportions choisies de l'ensemble B (NMI exprimé en pourcents).



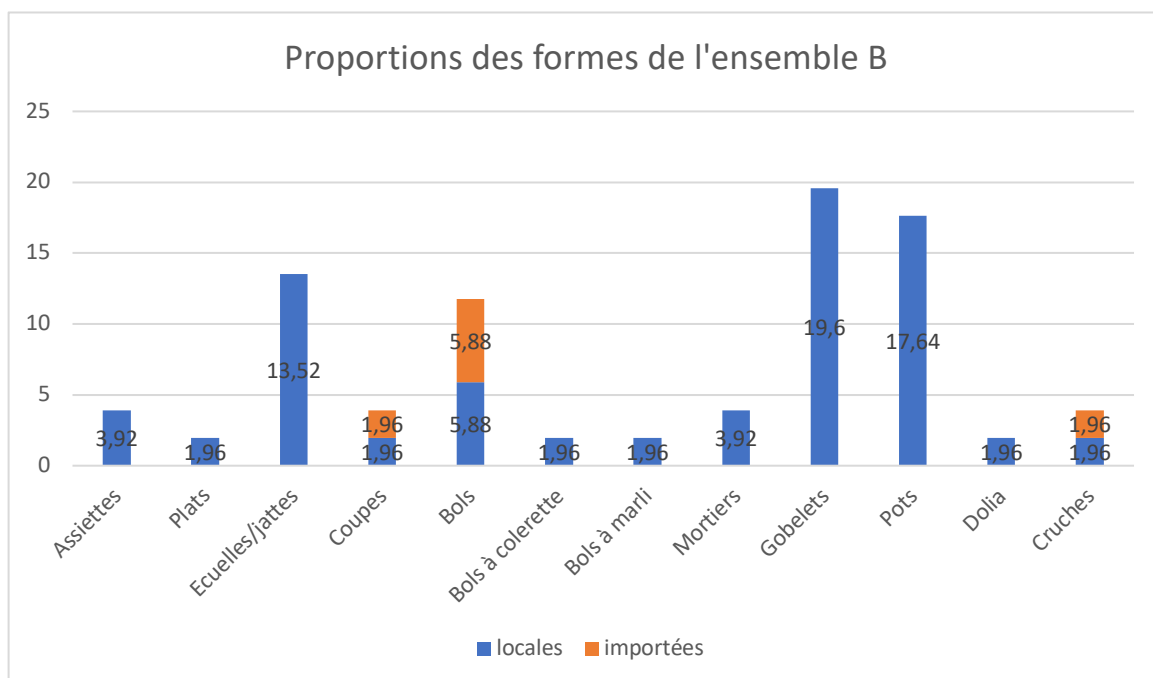
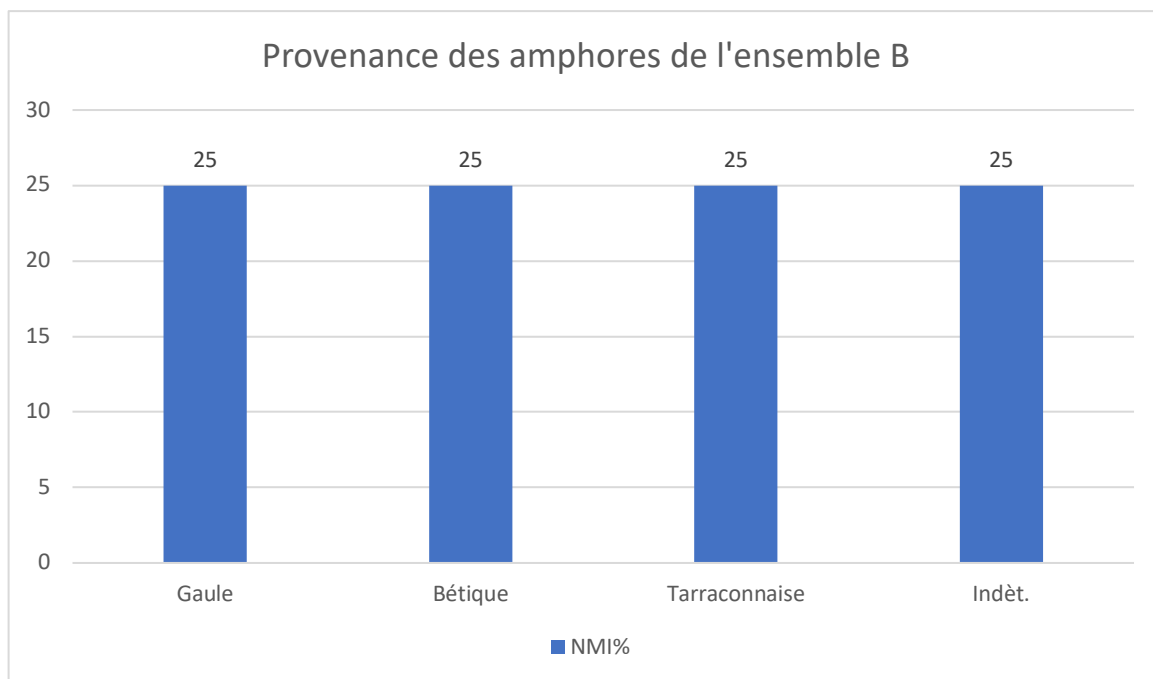


Fig. 16.2: Tableau des céramiques de l'ensemble B.

UF	NMI	Categorie	Forme	Type	Bord	Fond	Panse	Anse	Profil	NR	Décor	Commentaire	Inscription	Inventaire	Illustration
555	2	TSGM	Bol	Drag. 37	1					1				VB14.555.47	Pl. 11.1, n°1
555		TSGM	Coupe	Indét.		2				2					
555		TSGM	Indét.				1			1					
555	2	TSGC	Bol	Drag. 37	1		1			1				VB14.555.48	Pl. 11.1, n°2
555		TSGC	Bol	Drag. 37		1				4					
555		TSGC	Bol	Indét.		1				1					
555		TSGC	Cruche	Indét.	1					1		Frag. diamètre 6 cm			
555		TSGC	Indét.				3			3					
555	1	TSGE	Bol	Drag. 37	1					1					
555		TSGE	Indét.				3			3					
555	1	CP A	Indét.			1				1	Bandeau blanc/lie de vin				
555		CP A	Indét.				6			6					
555	4	TSI	Assiette	Imit. Drag. 15/17, L7	1					1				VB14.555.71	Pl. 11.1, n°3
555		TSI	Bol	Drack 21	1		2			3					
555		TSI	Bol	Indét.		1	3			9					
555		TSI	Mortier	Indét.			1			1					
555		TSI	Gobelet	Indét.		1				5					
555		TSI	Indét.				3			3					
555		TSI	Indét.			2	4			6					
555	1	TSITG	Coupe	Indét.		1				1					
555	1	PGF	Indét.				3			3					
555	1	RAMAT	Indét.				1			1					
555	7	RALUIS	Gobelet	LS RA G.1.5	1					1				VB14.555.61	Pl. 11.1, n°4
555	7	RALUIS	Gobelet	LS RA G.1.7.a	1					2				VB14.555.67	Pl. 11.1, n°5
555		RALUIS	Gobelet	LS RA G.2.1	1					1				VB14.555.64	Pl. 11.1, n°6
555		RALUIS	Gobelet	RA G.2.1	1					1					
555		RALUIS	Gobelet	RA G.2.1	1					1	Sablé			VB14.555.68	Pl. 11.1, n°7
555		RAMAT	Gobelet	AV 100	1					1				VB14.555.66	Pl. 11.1, n°9
555		RALUIS	Mortier	Indét.			3			3		Brulé, collerette			
555		RALUIS	Gobelet	Indét.		2	17			19					
555		RALUIS	Gobelet	Indét.			14			14	Guilloché				
555		RALUIS	Gobelet	Indét.		1	3			4		Brulé			
555		RALUIS	Gobelet	Indét.			1			1	Guilloché et demi cercle + points imprimés				
555		RALUIS	Gobelet	Indét.			7			7					
555		RALUIS	Gobelet	Indét.			11			11	Guilloché				
555		RALUIS	Gobelet	Indét.		4				4					
555		RALUIS	Gobelet	Indét.			1			1	Occlulé				
555		RALUIS	Gobelet	Indét.			1			1	Cercles à la barbotine				
555		RALUIS	Indét.				4			4					
555		RALUIS	Indét.			1				1	Brulé, grésé				
555		RALUIS	Indét.				9			9					

555	2	RAMET	Gobelet	LS RA G.2.2	1				3				VB14.555.46	Pl. 11.1, n°8
555		RAMET	Bol	Indét.			1		1	Guilloché				
555		RAMET	Gobelet	Indét.		1	8		9					
555		RAMET	Gobelet	Indét.			2		2	Guilloché				
555		RAMET	Gobelet	Indét.		1			1					
555		RAMET	Gobelet	Indét.			3		3		1 pn points de chaux			
555		RAMET	Gobelet	Indét.			6		6	Guilloché				
555	2	RANOIR	Gobelet	Nied. 32-33	1				1				VB14.555.45	Pl. 11.1, n°10
555		RANOIR	Gobelet	Nied. 33	1		1		2				VB14.555.44	Pl. 11.1, n°11
555		RANOIR	Gobelet	Indét.		1	4		5	Guilloché				
555		RANOIR	Gobelet	Indét.		1	12		12					
555	1	EIR	Plat	Indét.		1			1					
555	4	MICAC	Ecuelle/Jatte	LS MIC E.1.1	1				1					
555		MICAC	Ecuelle/Jatte	LS MIC E.1.1	1				1				VB14.555.54	Pl. 11.1, n°12
555		MICAC	Bol à marli	LS MIC B.2.5	1				1				VB14.555.52	Pl. 11.1, n°13
555		MICAC	Pot	Indét.	1				1					
555		MICAC	Indét.		1		1		2		Bord frag.			
555	2	PGTN	Pot	LS PG P.2.2	1				1				VB14.555.63	Pl. 11.2, n°14
555		PGTN	Assiette	Indét.			2		2					
555		PGTN	Pot	Indét.			2		2	Godrons				
555		PGTN	Indét.				2		2					
555		PGTN	Indét.				1		1	Guilloché				
555		PGTN	Indét.				2		2					
555	1	PCCRU	Cruche	Indét.			6	1	7					
555		PCCRU	Cruche	Indét.			8	1	9					
555	2	PCMOR	Mortier	LS MOR Mo.3.2.b	1				1				VB14.555.60	Pl. 11.2, n°15
555		PCMOR	Mortier	LS MOR Mo.3.3			1		1				VB14.555.72	Pl. 11.2, n°16
555		PCMOR	Mortier	Indét.			2		2		Collerette			
555		PCMOR	Mortier	Indét.			2		2		collerettes			
555	10	PC	Ecuelle/Jatte	LS PC E.2.1	1				2				VB14.555.49	Pl. 11.2, n°17
555		PC	Ecuelle/Jatte	LS PC E.2.2	1				1				VB14.555.56	Pl. 11.2, n°18
555		PC	Ecuelle/Jatte	LS PC E.2.3.b	1				1					
555		PC	Ecuelle/Jatte	LS PC E.2.3.b	1				1				VB14.555.57	Pl. 11.2, n°19
555		PC	Ecuelle/Jatte	cf. LS PG E.2.7.b	1				1				VB14.555.58	Pl. 11.2, n°20
555		PC	Ecuelle/Jatte	cf LS PG E.2.7	1				1				VB14.555.65	Pl. 11.2, n°21
555		PC	Ecuelle/Jatte	AV 283	1				1				VB14.555.53	Pl. 11.2, n°22
555		PC	Ecuelle/Jatte	HT	1				1				VB14.555.55	Pl. 11.2, n°23
555		PC	Bol à coleret	cf AV 218/1	1				1		Collerette arrachée		VB14.555.59	Pl. 11.2, n°24
555		PC	Pot	Indét.	1	2			3					
555		PC	Pot	Indét.	1				1		Pot?, frag.			
555		PC	Pot	Indét.	1				1					
555		PC	Indét.				116		116					
555		PC	Indét.			2	45		47					

555	8	PG	Ecuelle/Jatte	AV 225/2	1					1				VB14.555.62	Pl. 11.3, n°25
555		PG	Bol	cf. AV 160/1	1					1				VB14.555.50	Pl. 11.3, n°27
555		PG	Pot	LS PG P.2	1					1					
555		PG	Pot	LS PG P.2.7	1					1				VB14.555.69	Pl. 11.3, n°28
555		PG	Pot	LS PG P.2.10	1					1				VB14.555.43	Pl. 11.3, n°29
555		PG	Pot	LS PG P.3.7.b	1					1				VB14.555.70	Pl. 11.3, n°30
555		PG	Pot	AV 47	1					2				VB14.555.51	Pl. 11.3, n°31
555		PG	Dolium	Indét.				2		2					
555		PG	Indét.		1	2	47			49					
555		PG	Indét.			1	19			20					
555		PG	Indét.				2			2					Peigné
555		PG	Indét.				2			2					Guilloché
555		PG	Indét.		4					5					
555	2	PGGROS	Ecuelle/Jatte	AV 284/2						1	1			VB14.555.08	Pl. 11.3, n°26
555		PGGROS	Pot	Indét.			1			1					Impressions carrées
555		PGGROS	Indét.			1				1					
TOTAUX	61				46	31	402	2	1	497					

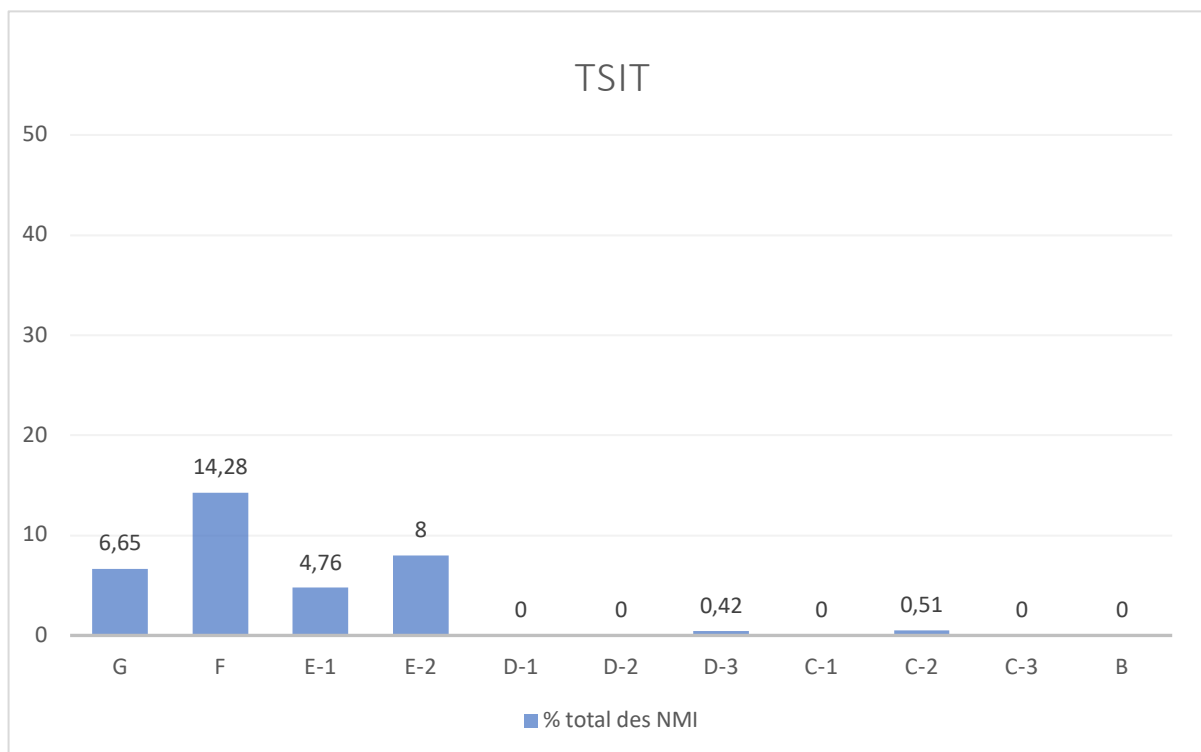
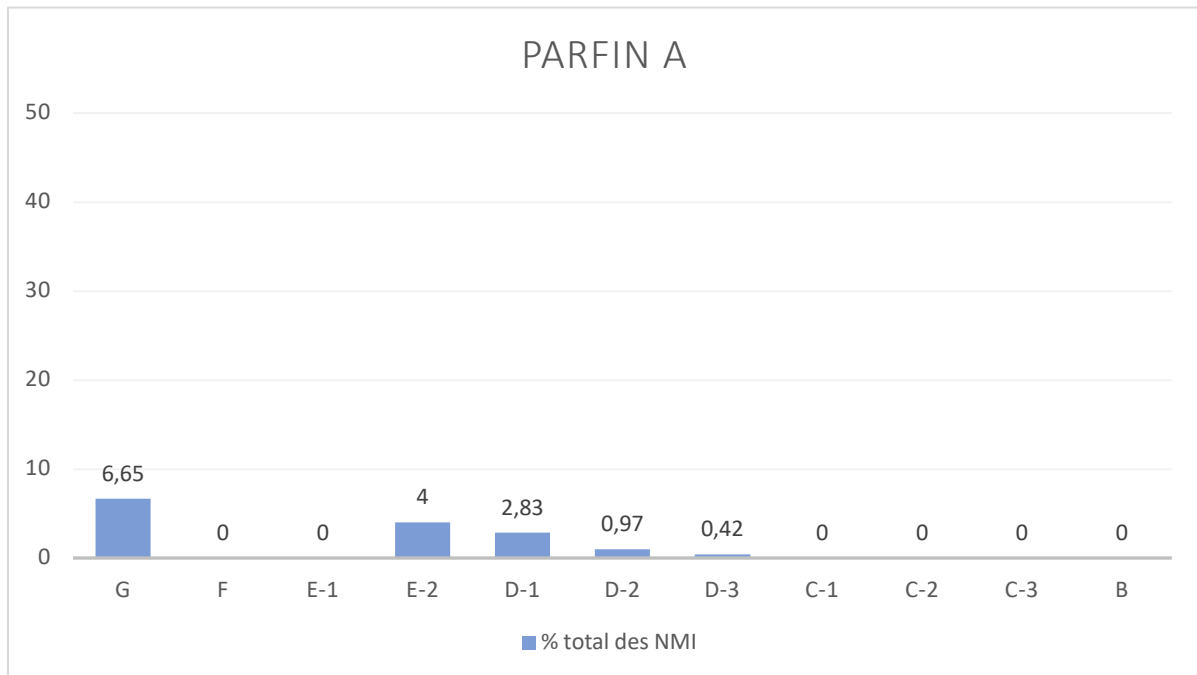
Fig. 16.3: Tableau des amphores de l'ensemble B.

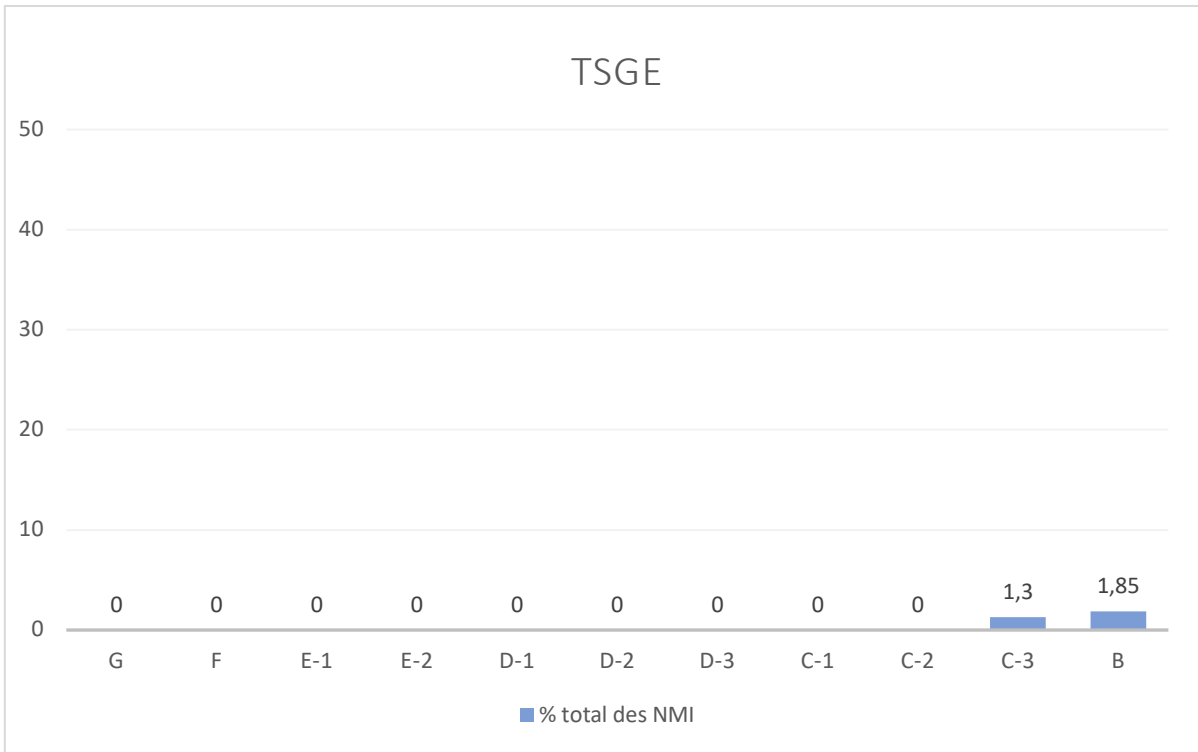
UF	NMI	Categorie	Forme	Type	Bord	Fond	Panse	Anse	Profil	NR	Décor	Commentaire	Inscription	Inventaire	Illustration
555	1	Gaule	Indét.				3			3					
555		Gaule	Indét.				16			16					
555		Gaule	indét.				13			13					
555	1	Bétique	Dressel 20				1			1					
555	1	Tarraconaise	Indét.				6	1		7		Demi anse			
555	1	Indét.	Amphorisque ?		1					1		Pâte beige moyen assez dure		VB14.555.14	Pl. 11.4, n°32
TOTAUX	4				1		39	1		41					

3.3. Évolution quantitative des catégories et formes céramiques

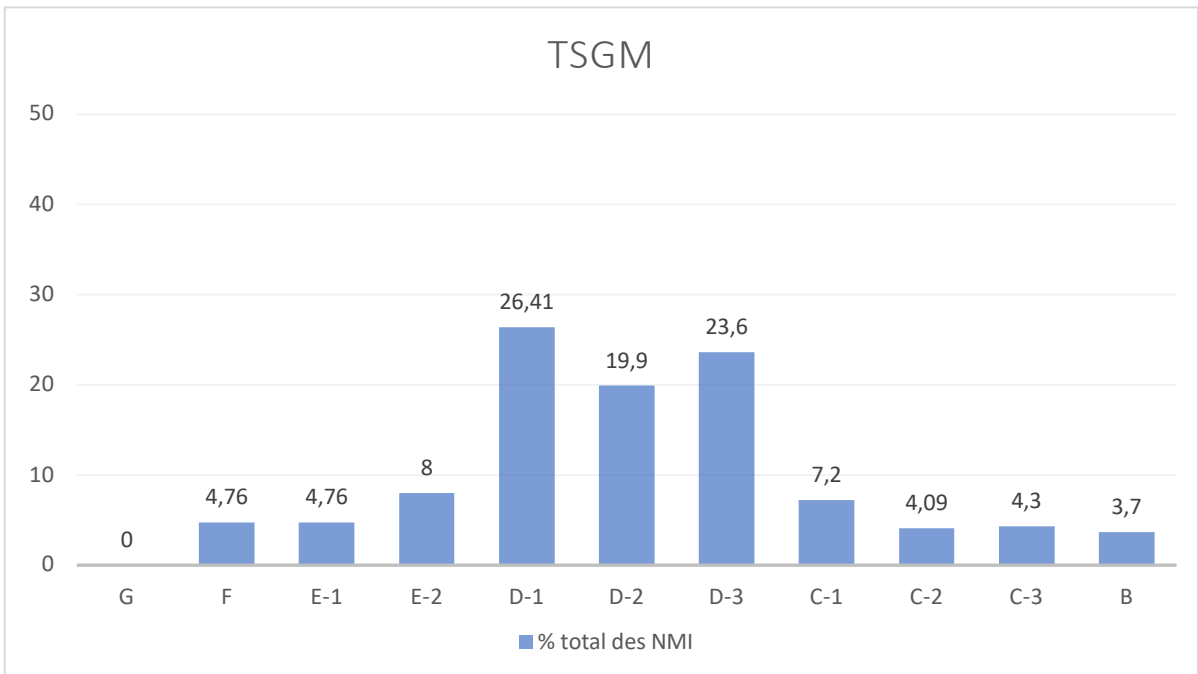
3.3.2. Évolution des catégories

Fig. 17.1: Fines importées (PARFIN A, TSIT, TSGM, TSGE, TSAF).





v



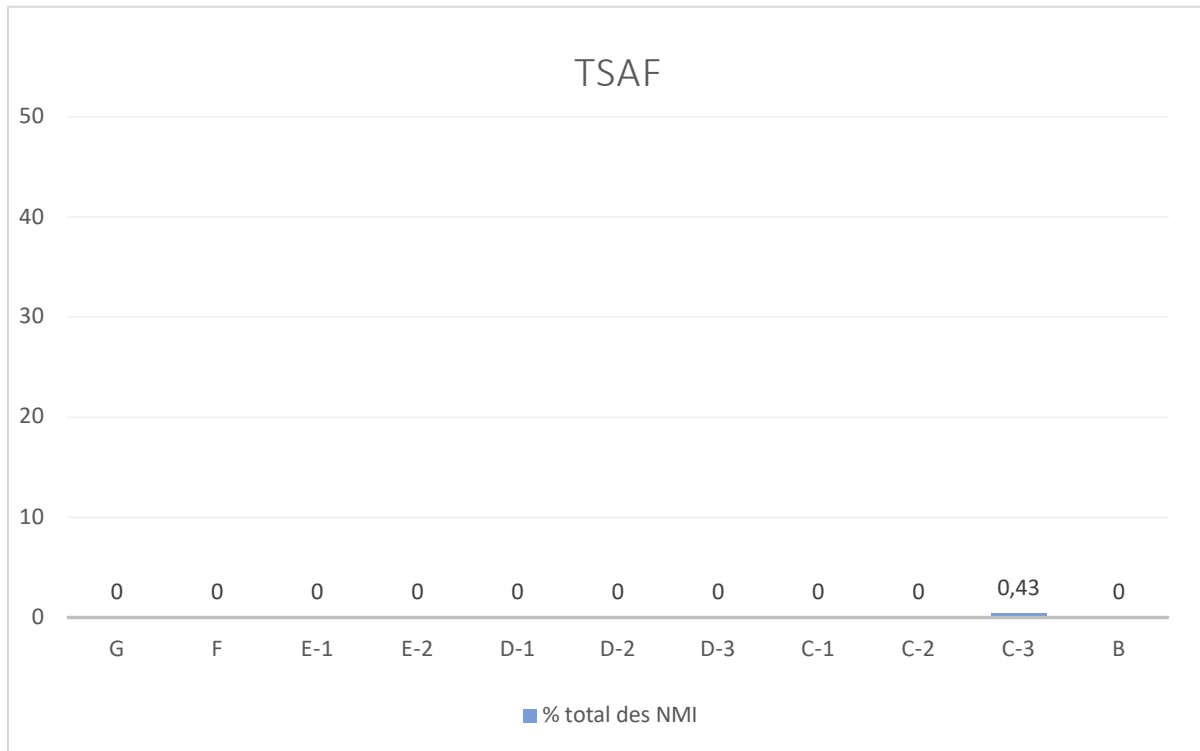
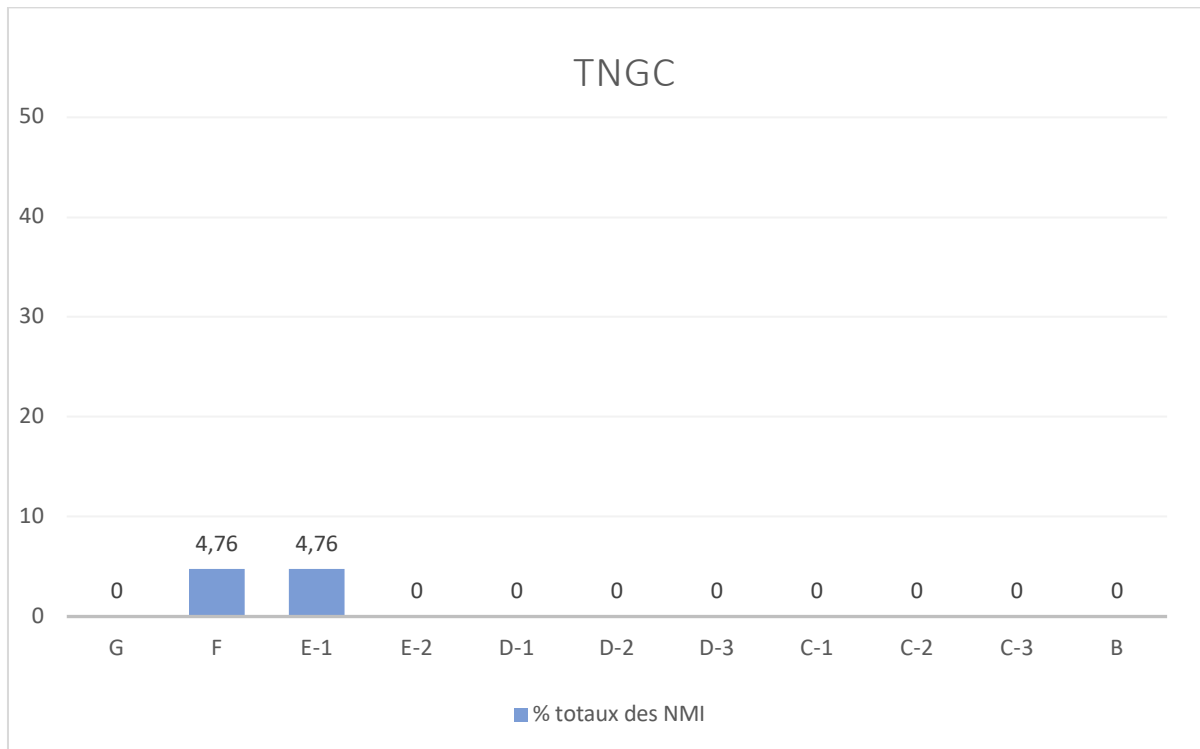


Fig. 17.2: Communes importées (TNGC, RAEXR, EIRP).



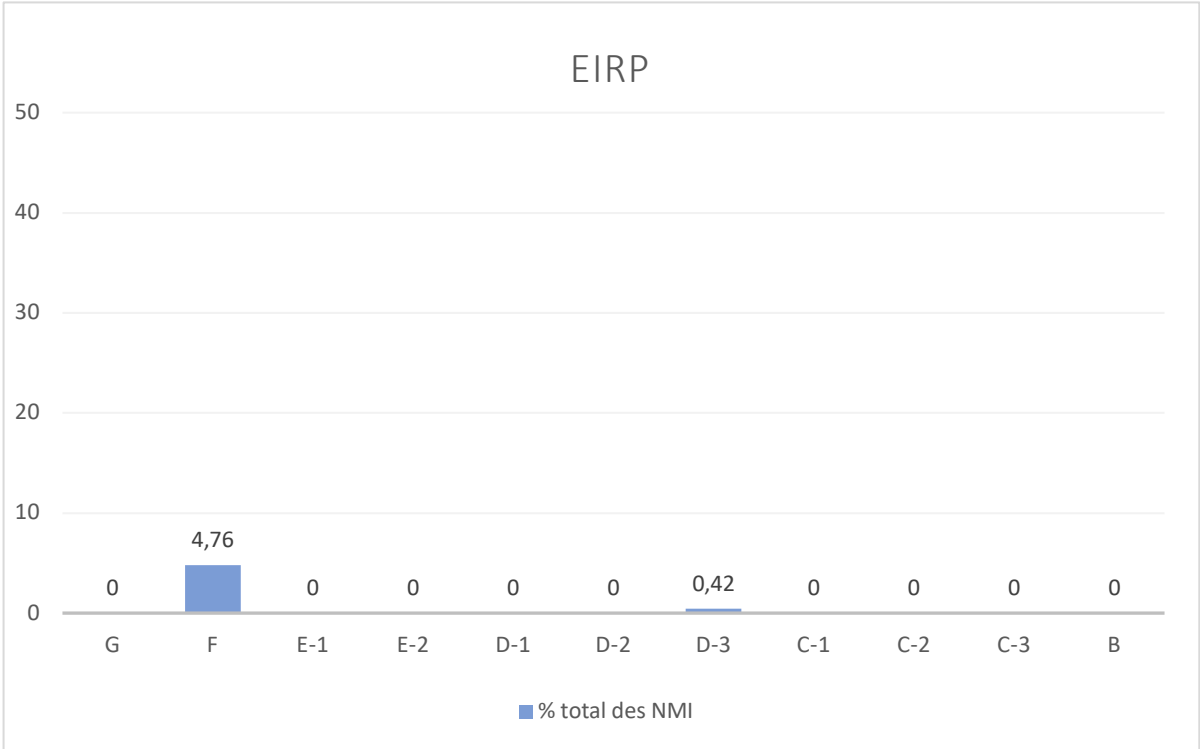
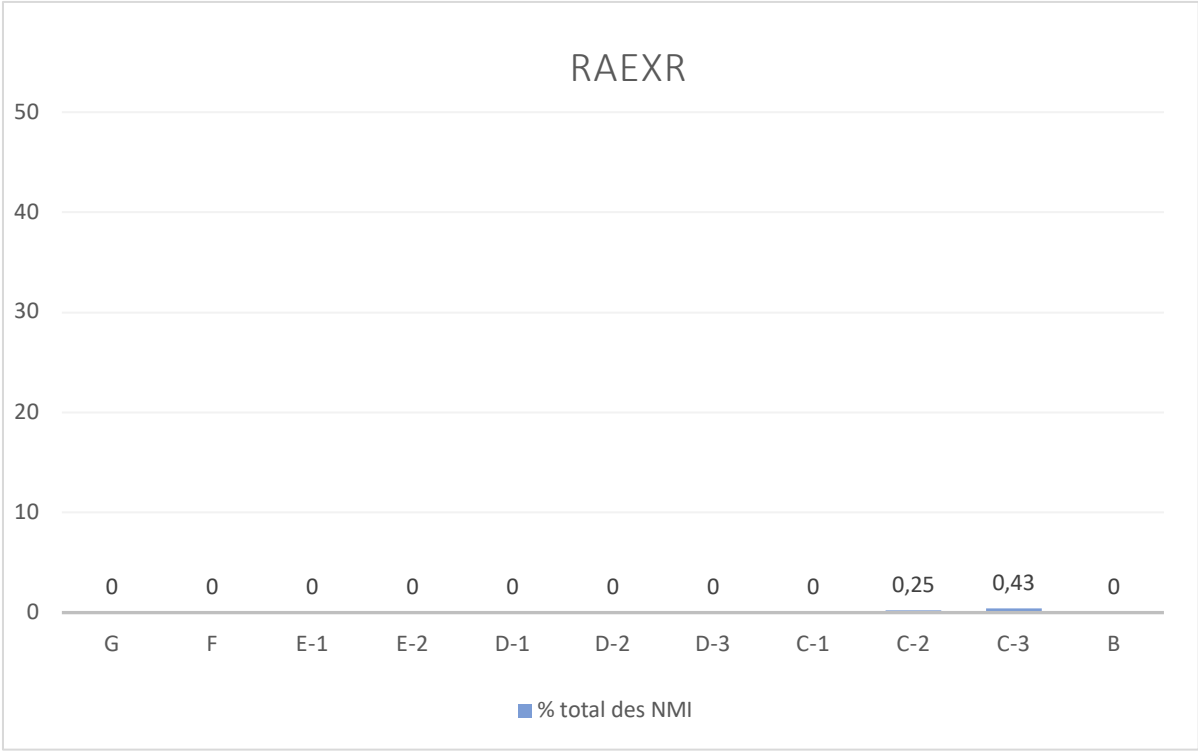
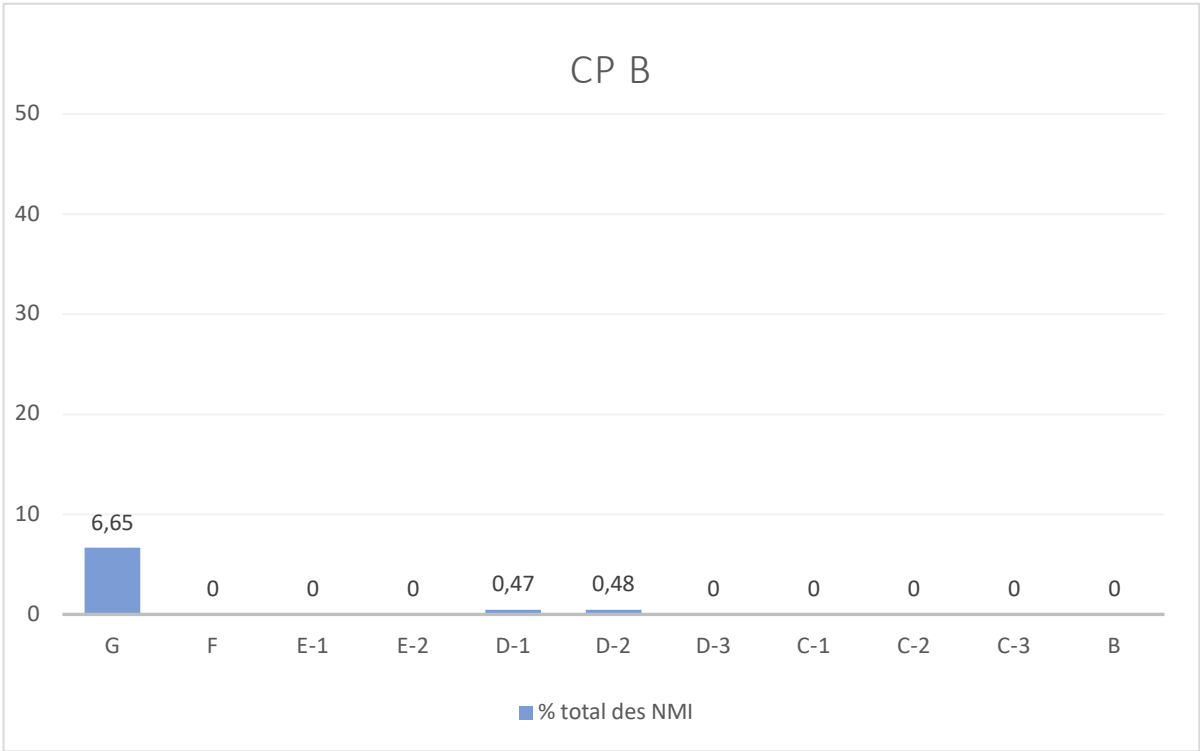
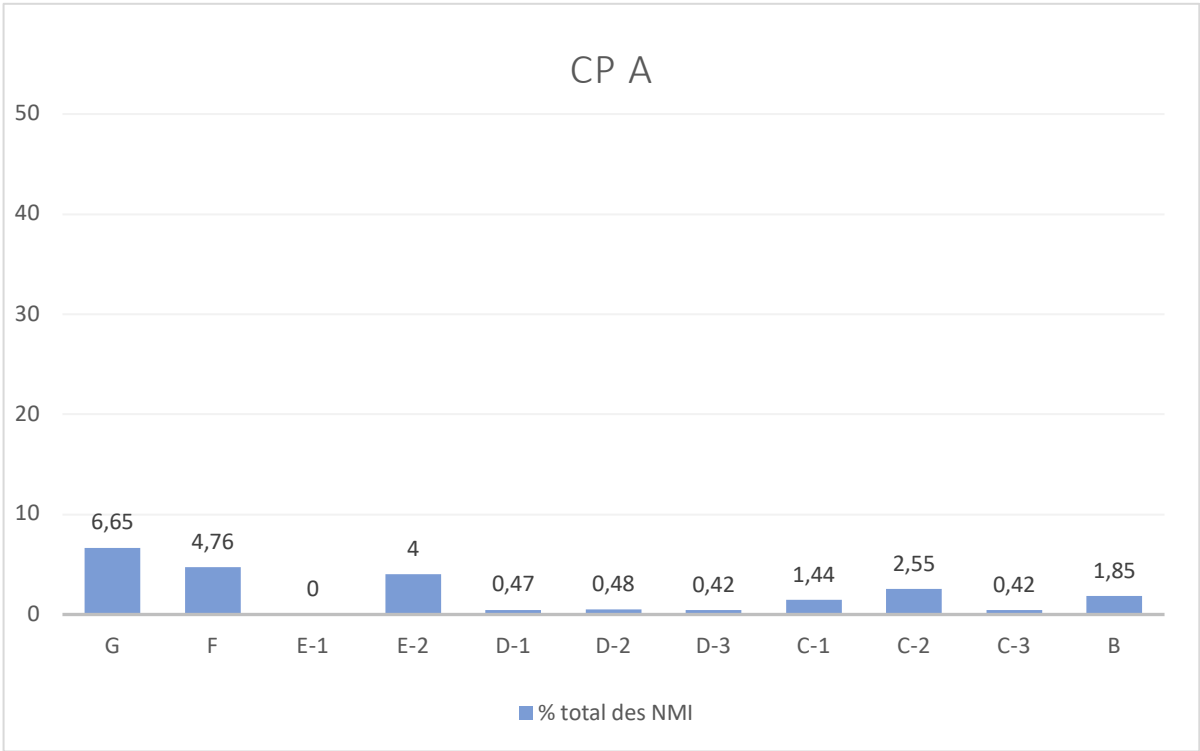
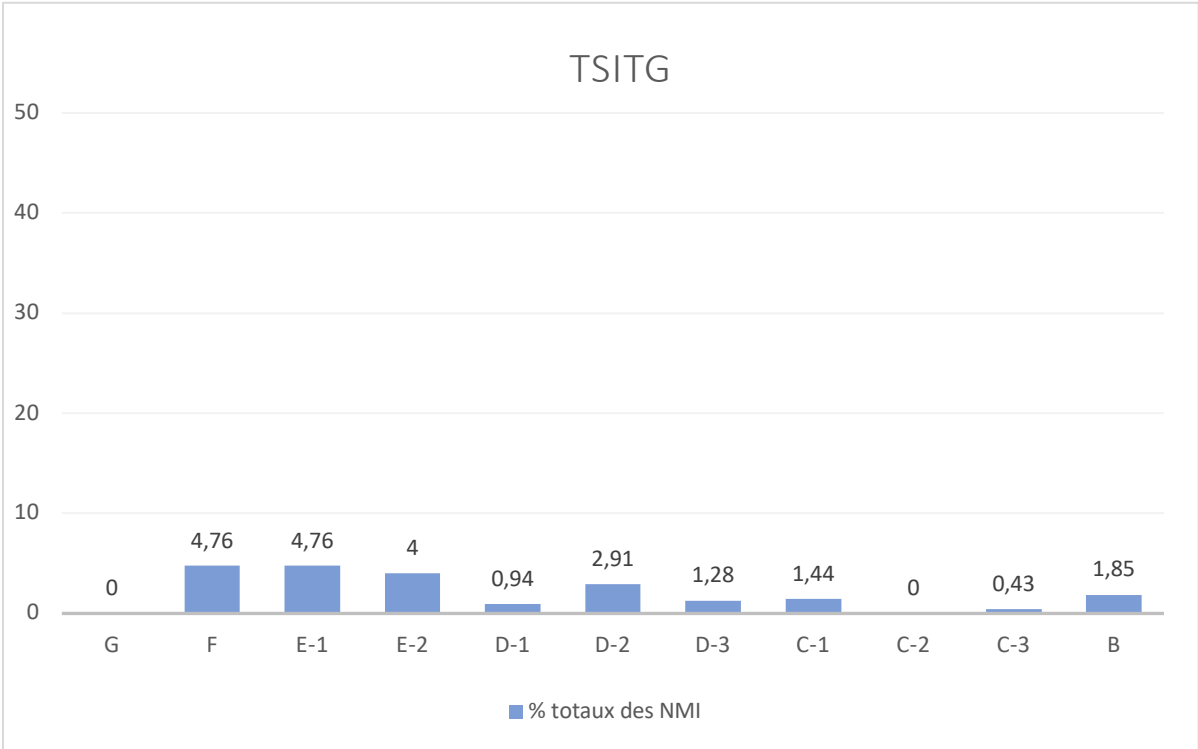
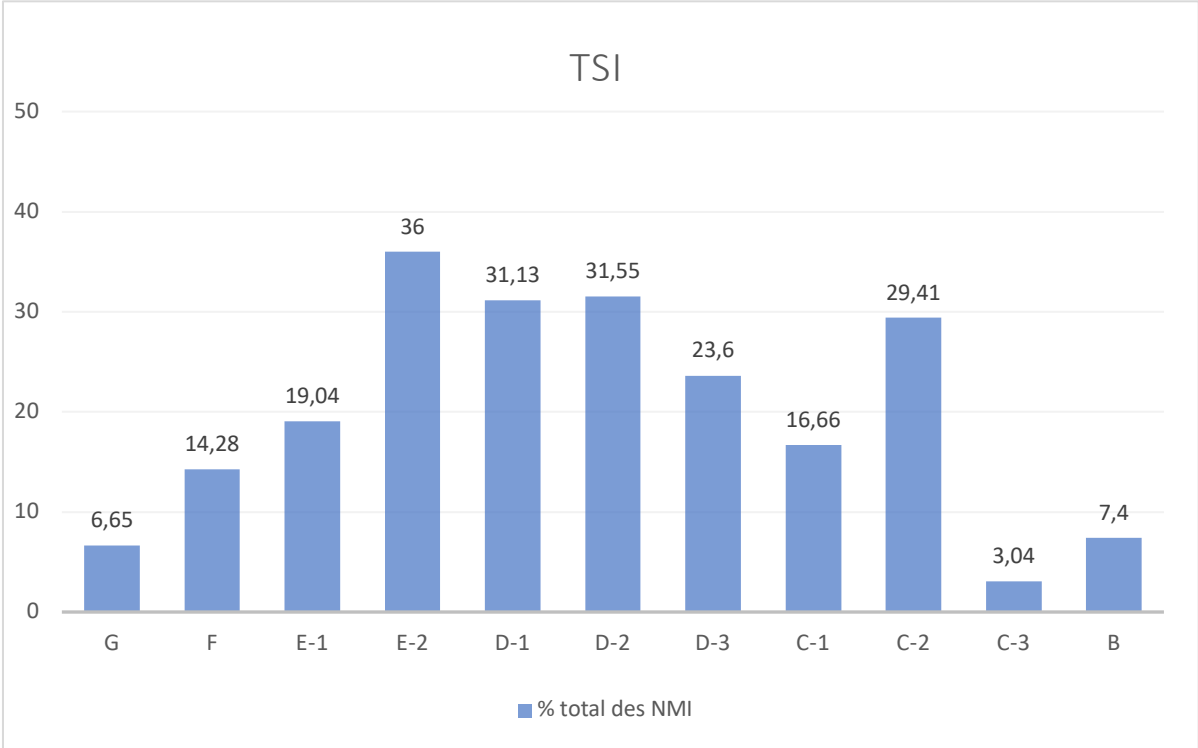


Fig. 17.3: Fines régionales (CP A, CP B, TSI, TSITG, PGF).





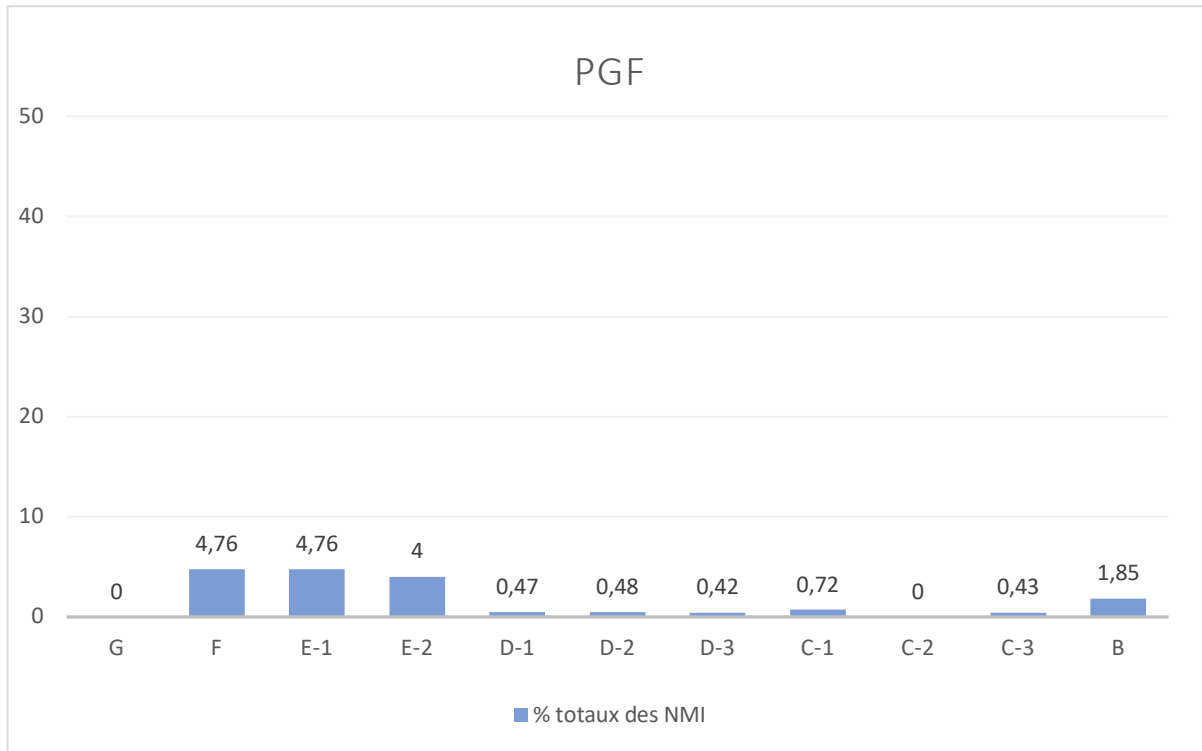
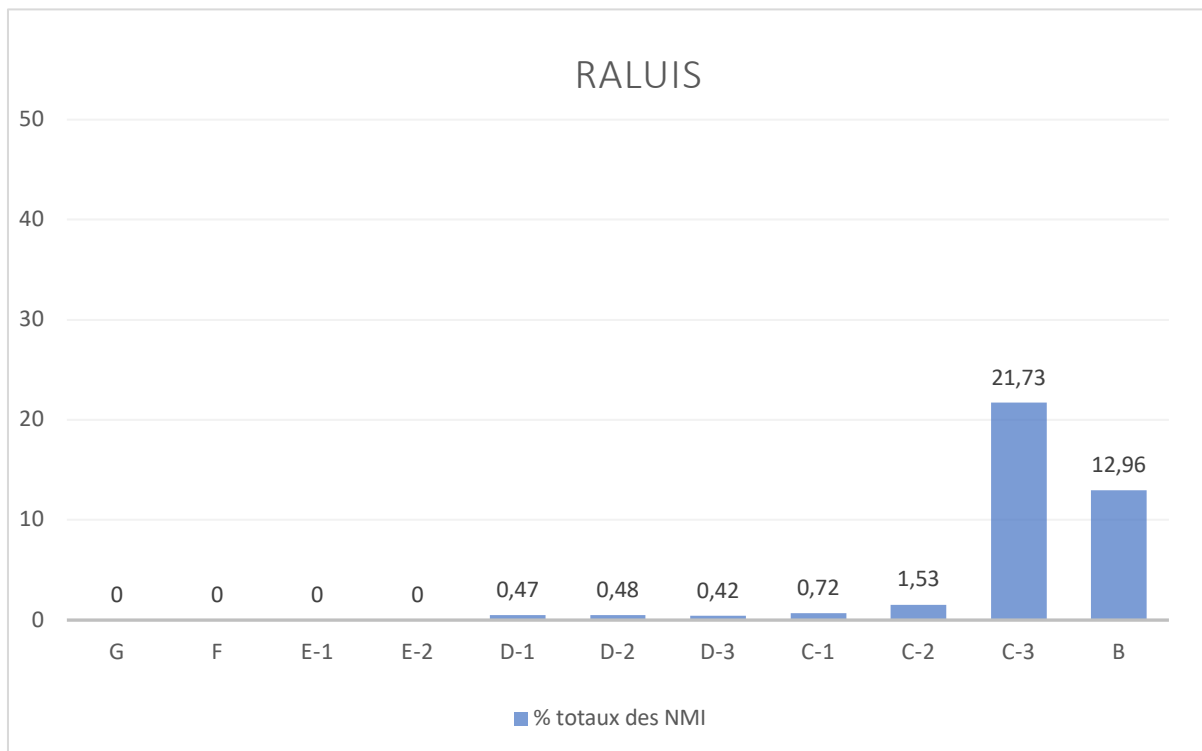
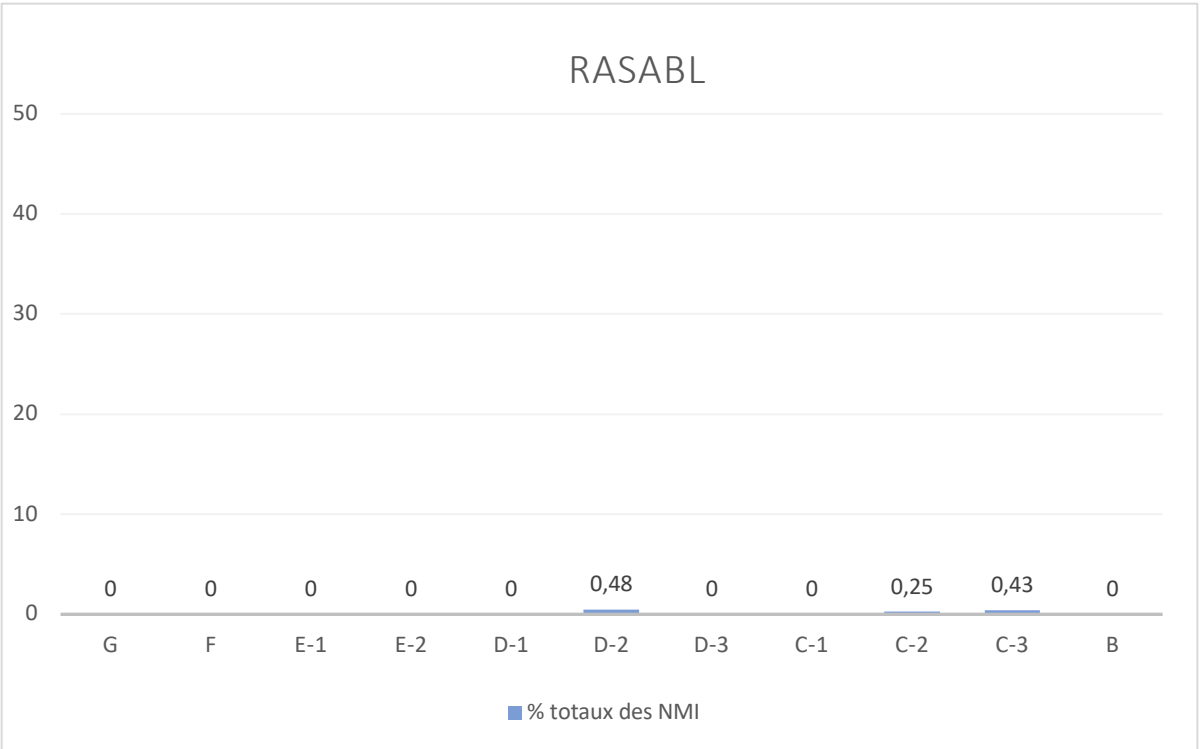
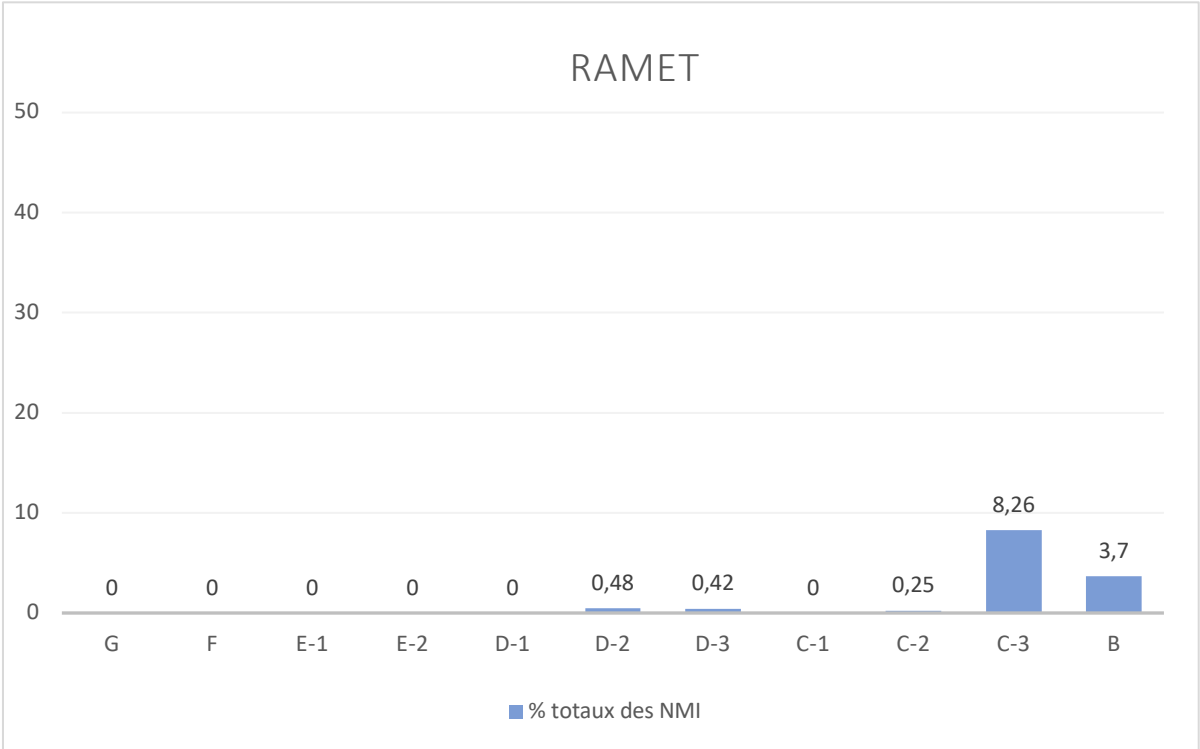


Fig. 17.4: Céramiques à revêtement argileux (RALUIS, RAMET, RASABL, RANOIR, RAMAT).





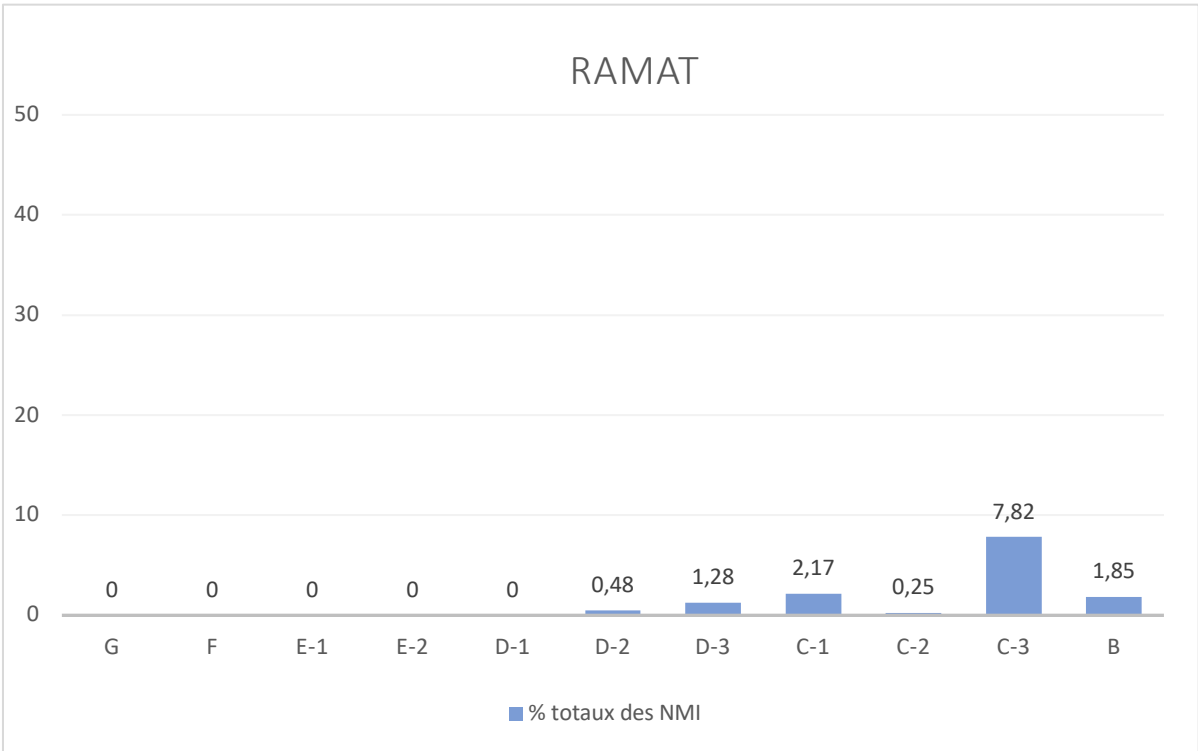
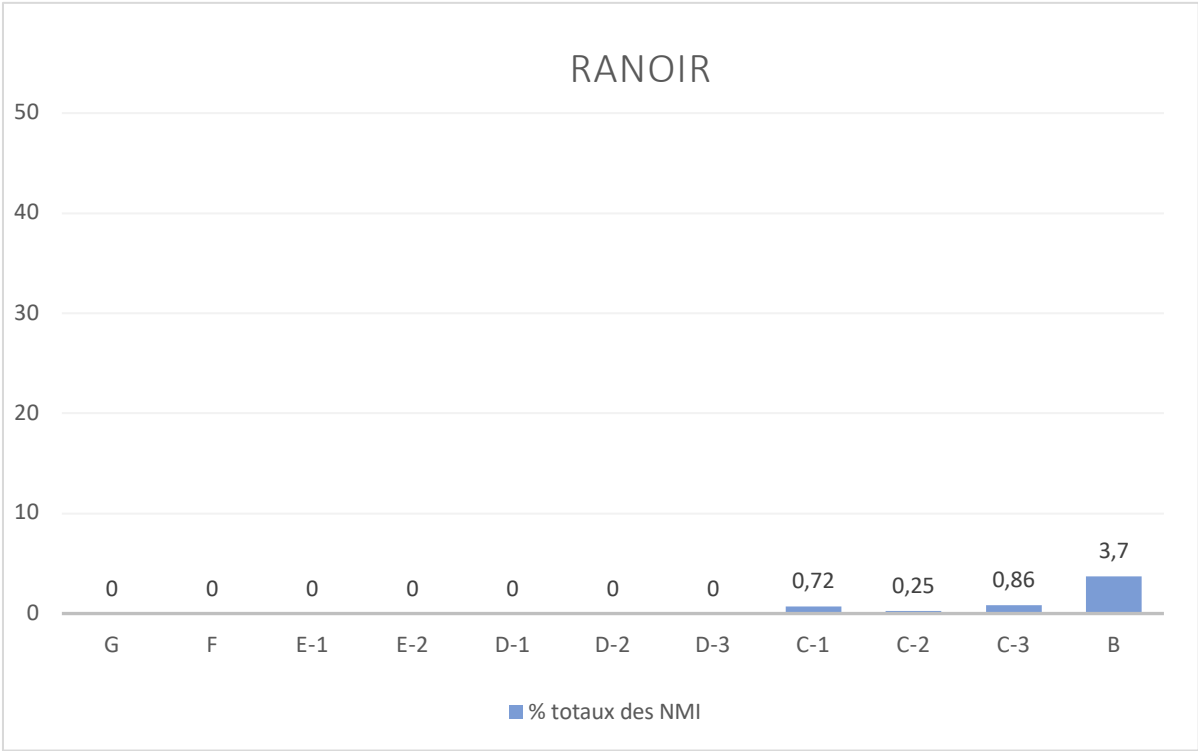
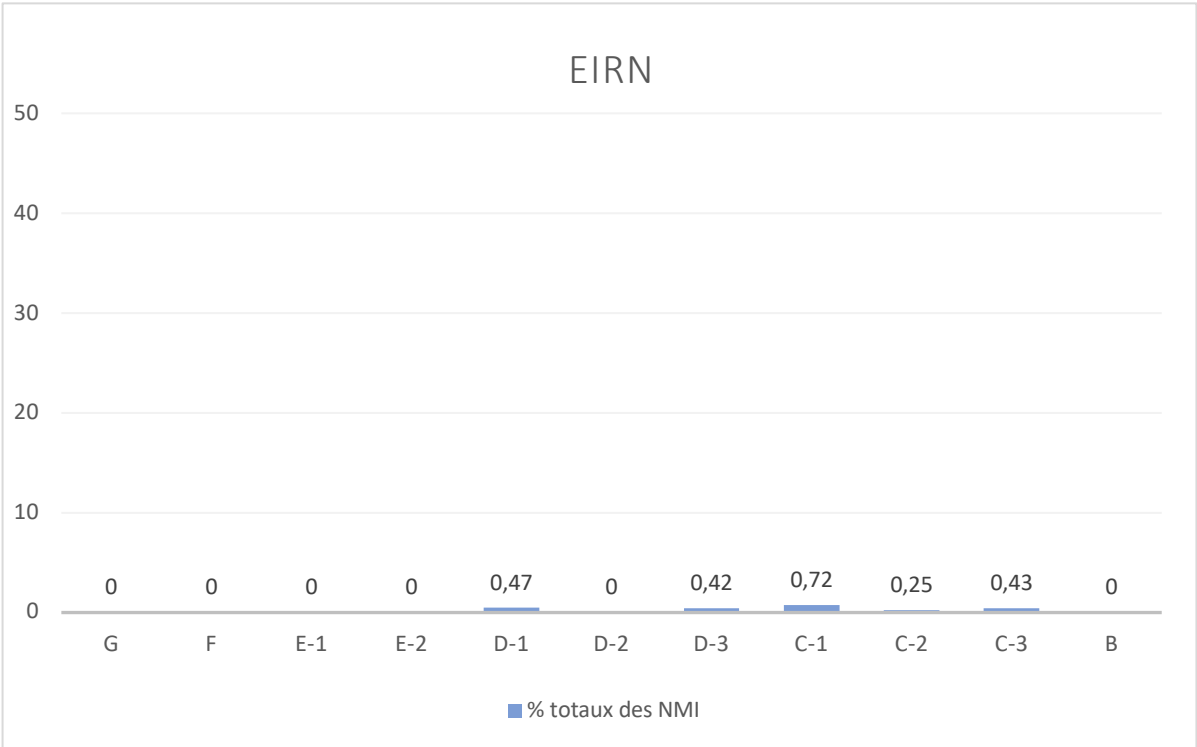
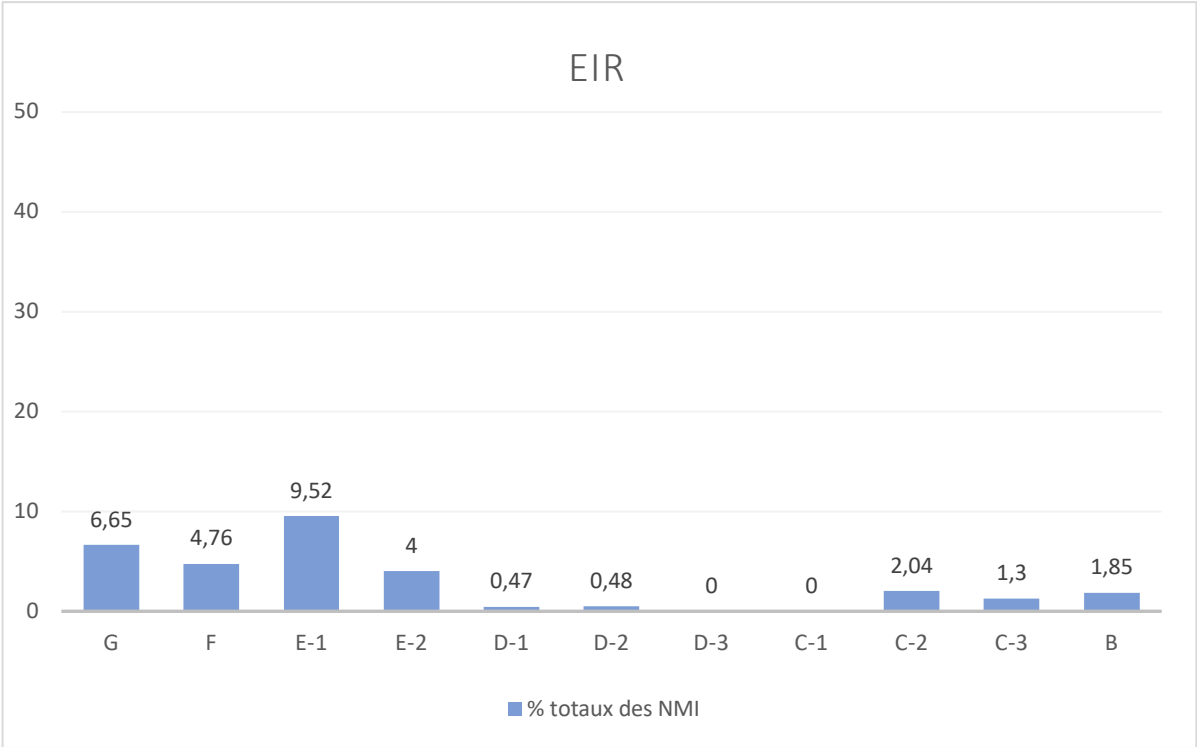


Fig. 17.5: Communes engobées ou lissées (EIR, EIRN, MICAC, PGTN).



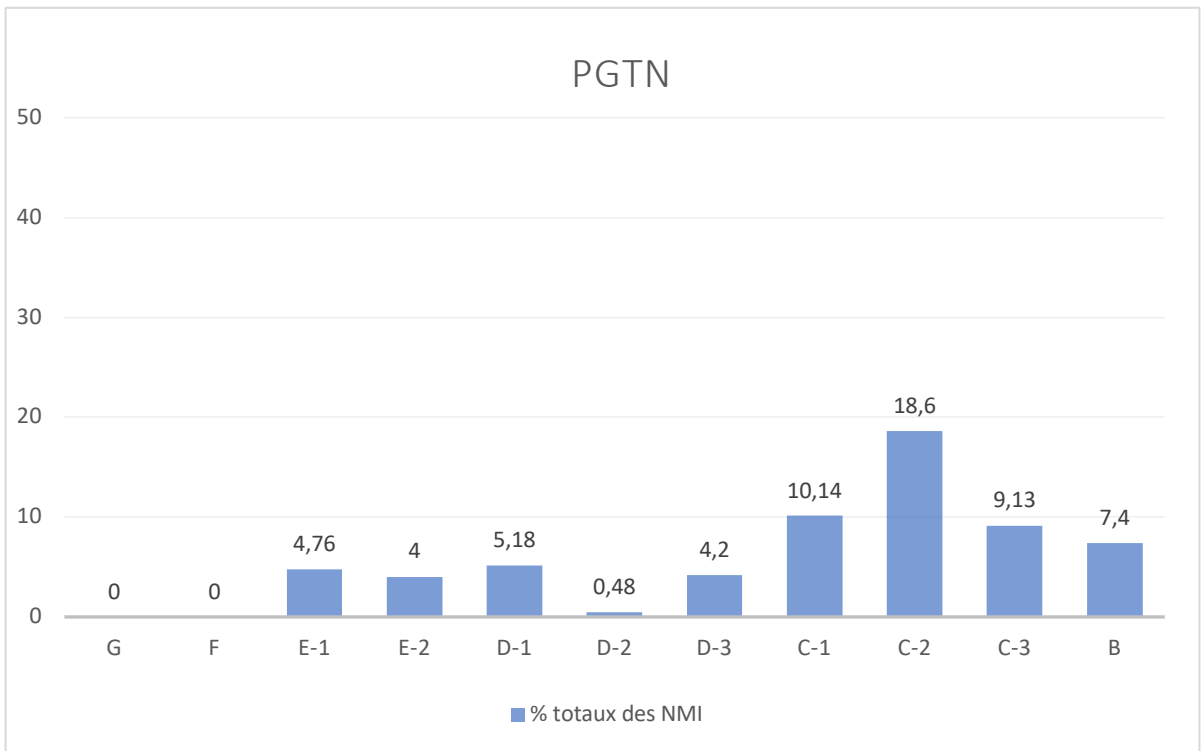
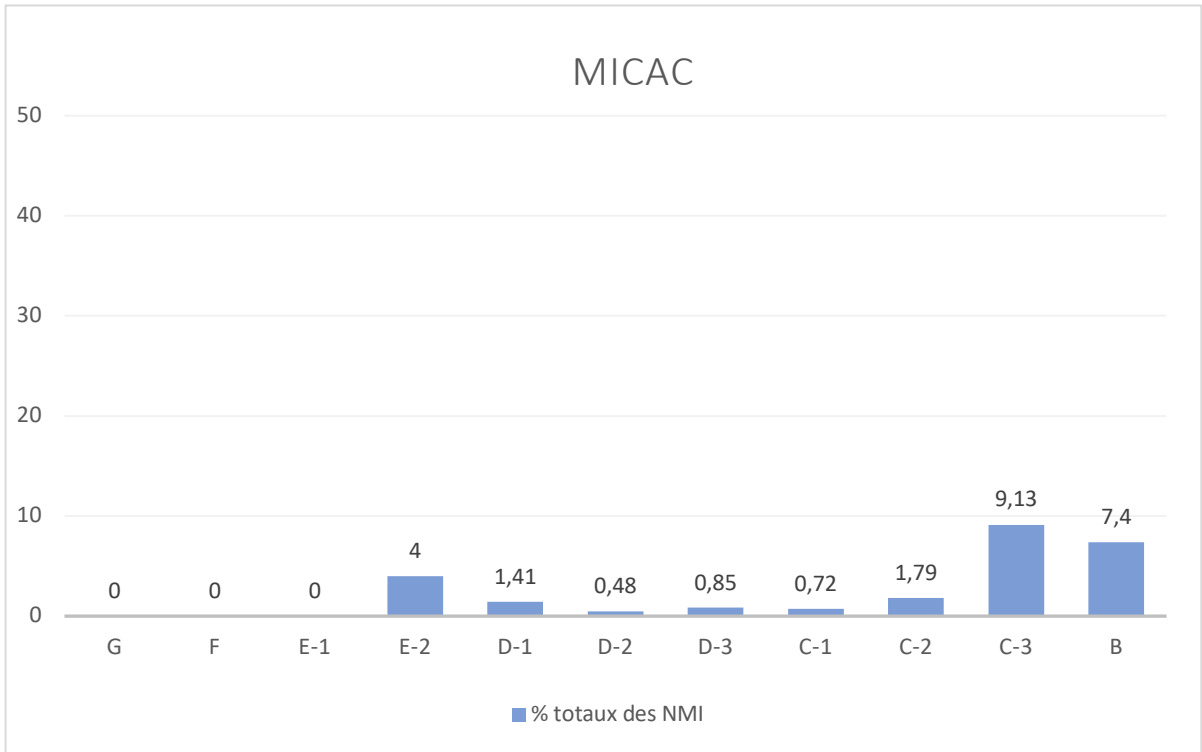
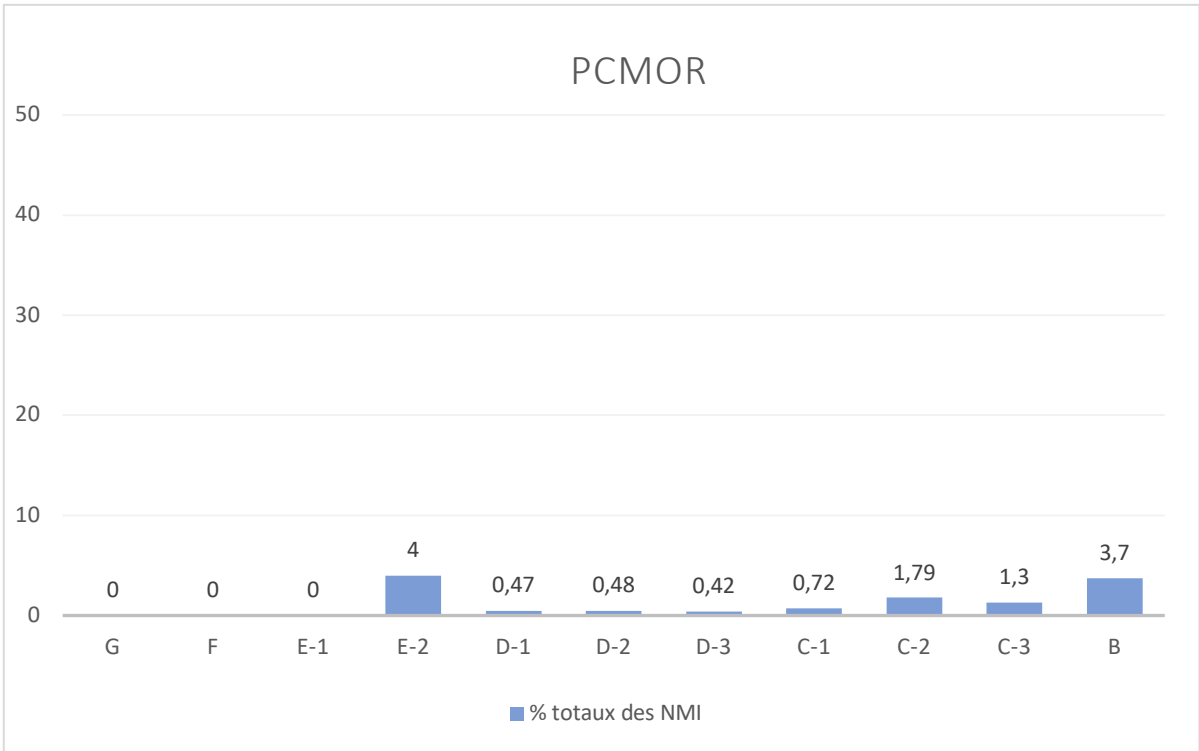
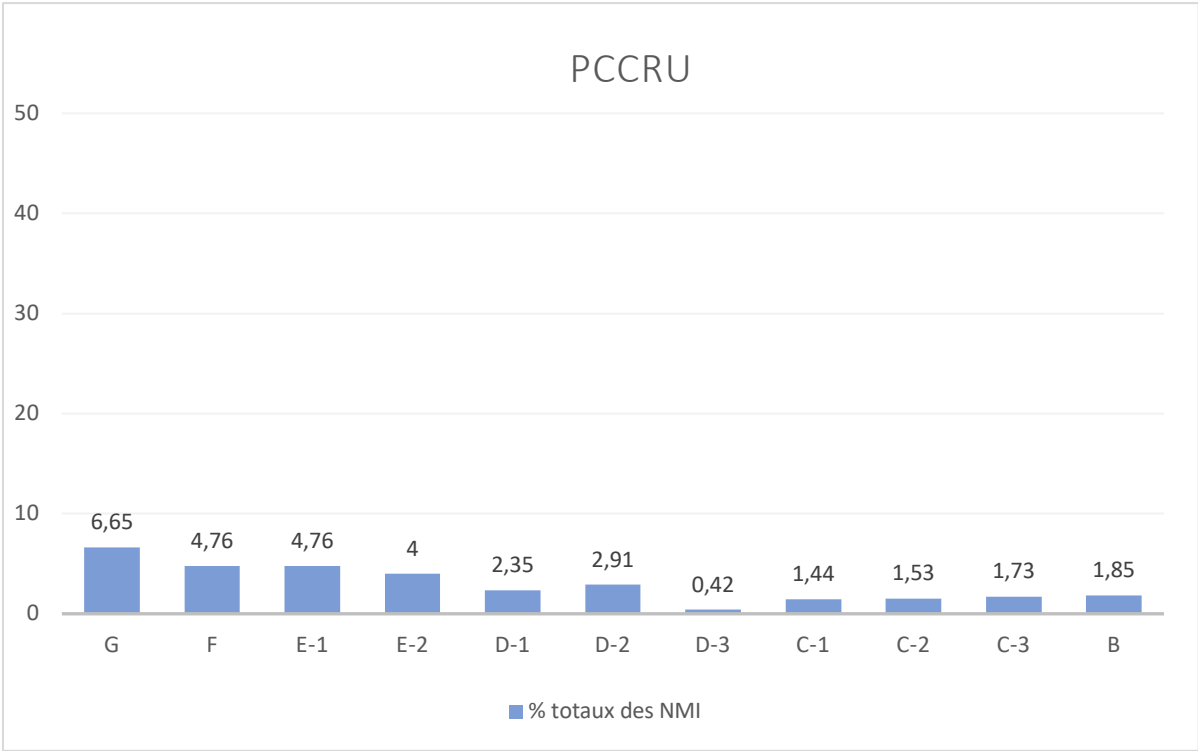
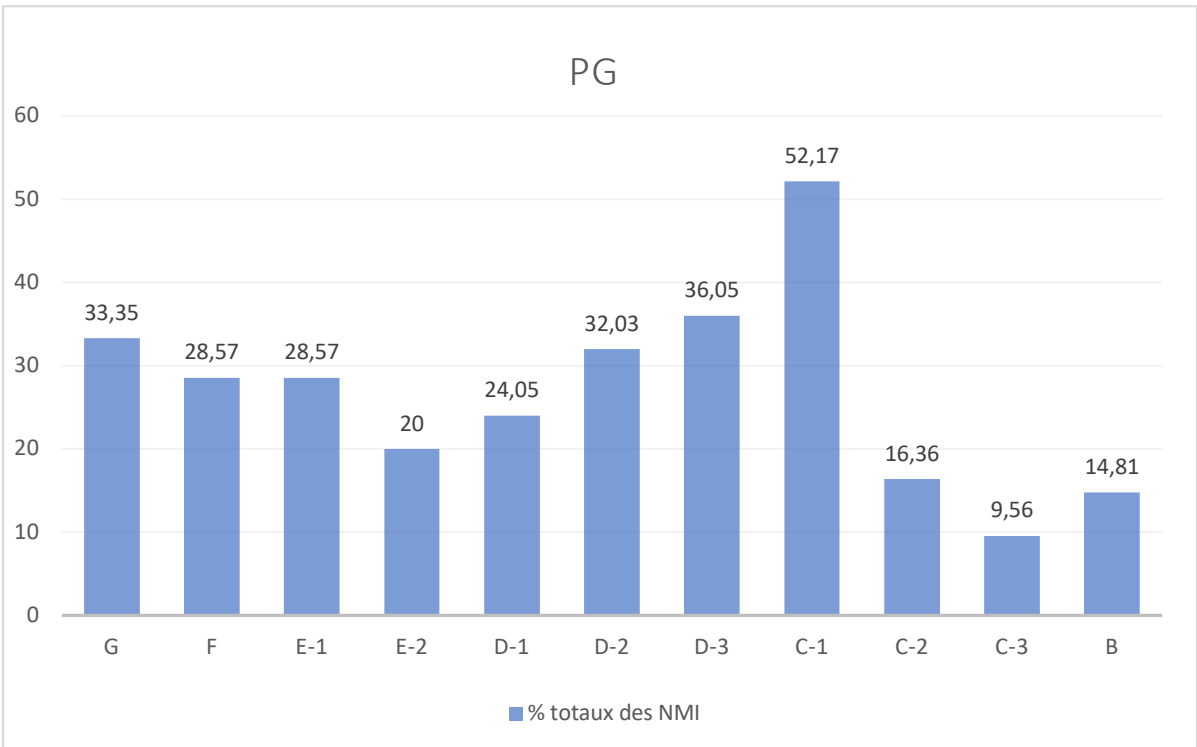
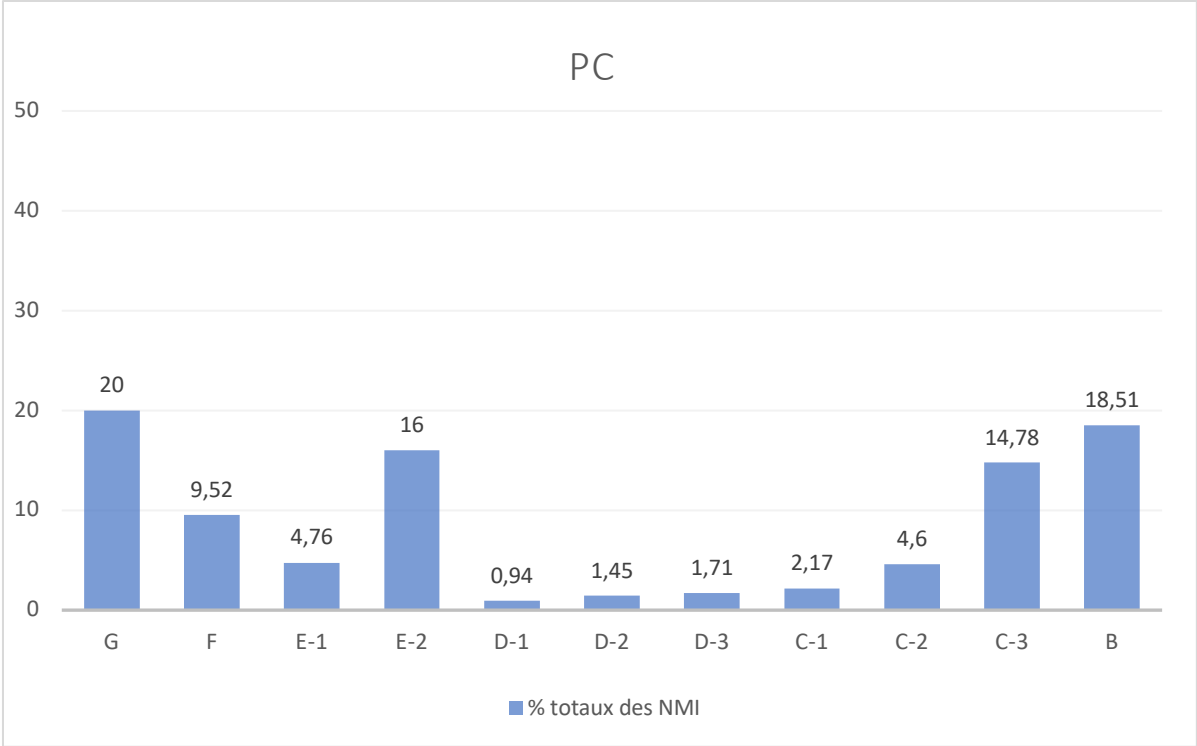


Fig. 17.6: Communes régionales oxydées et réduites (PCCRU, PCMOR, PC, PG, PGGROS).





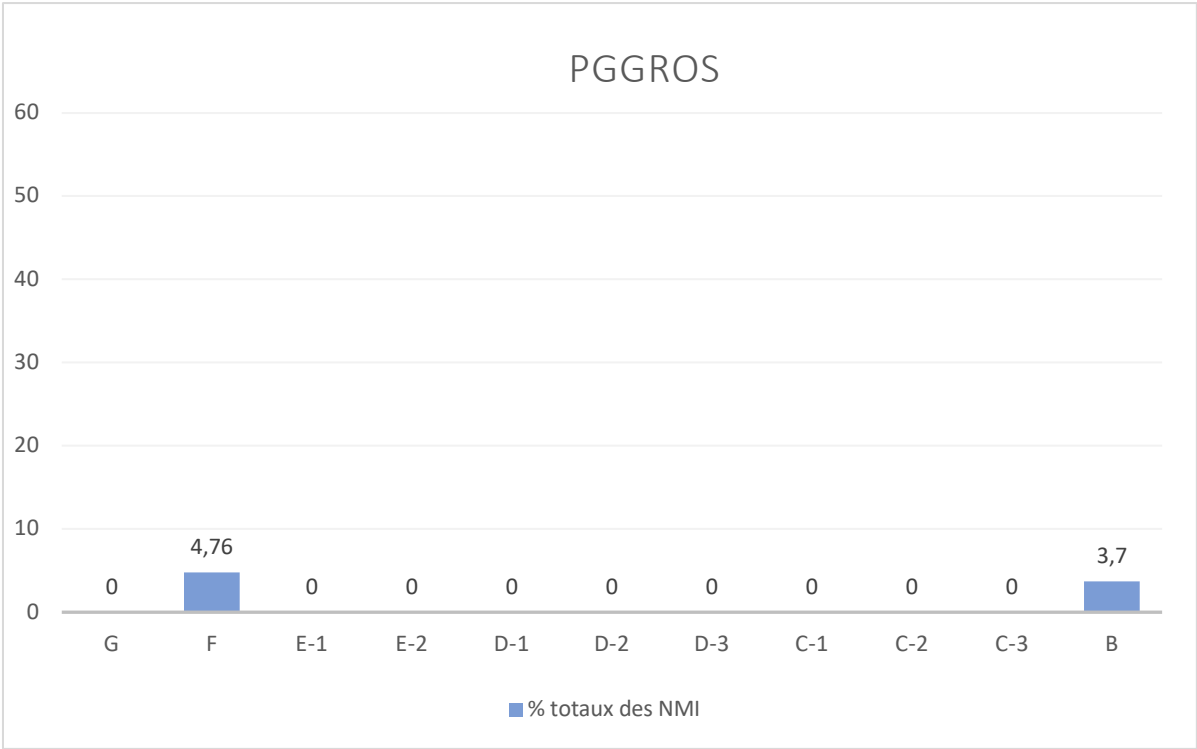
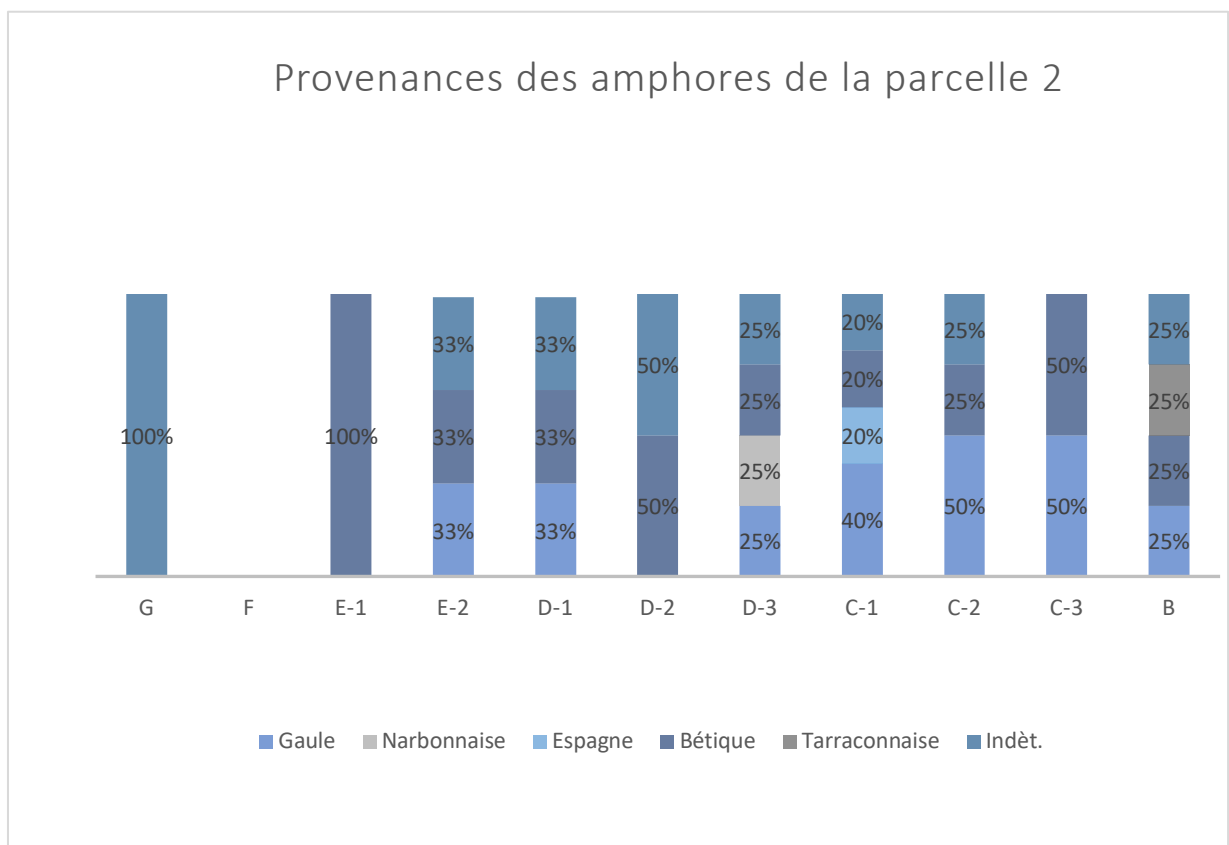
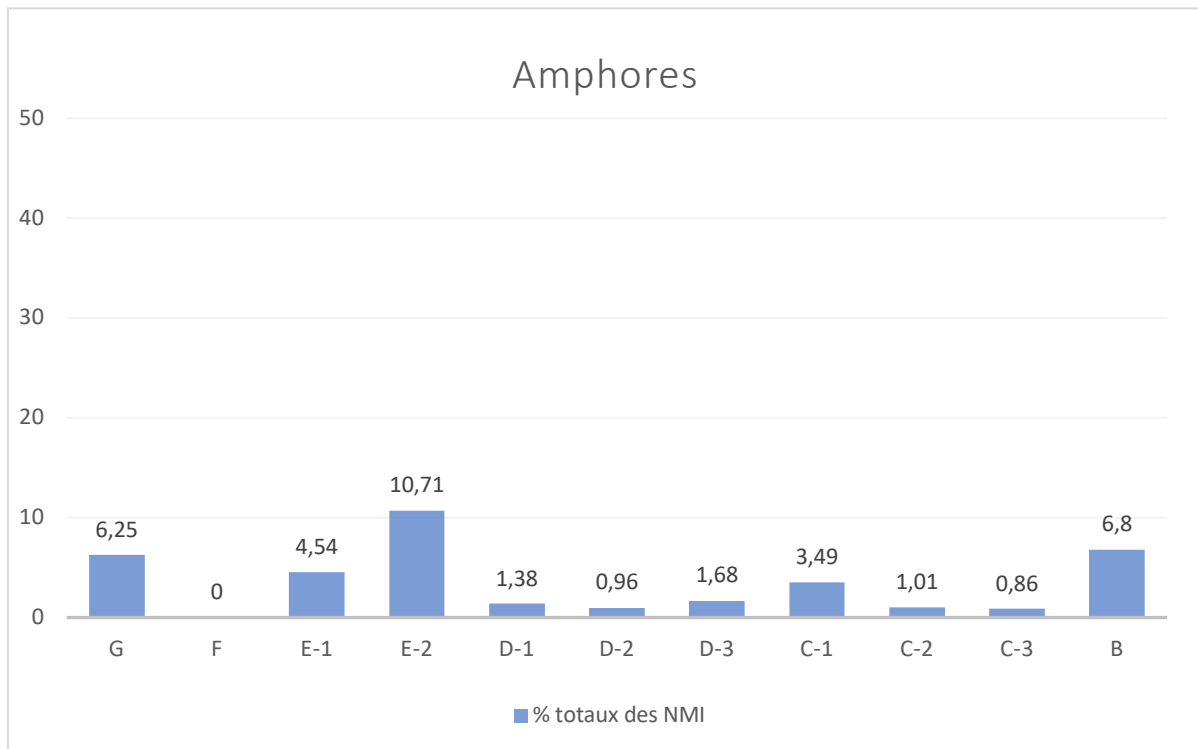


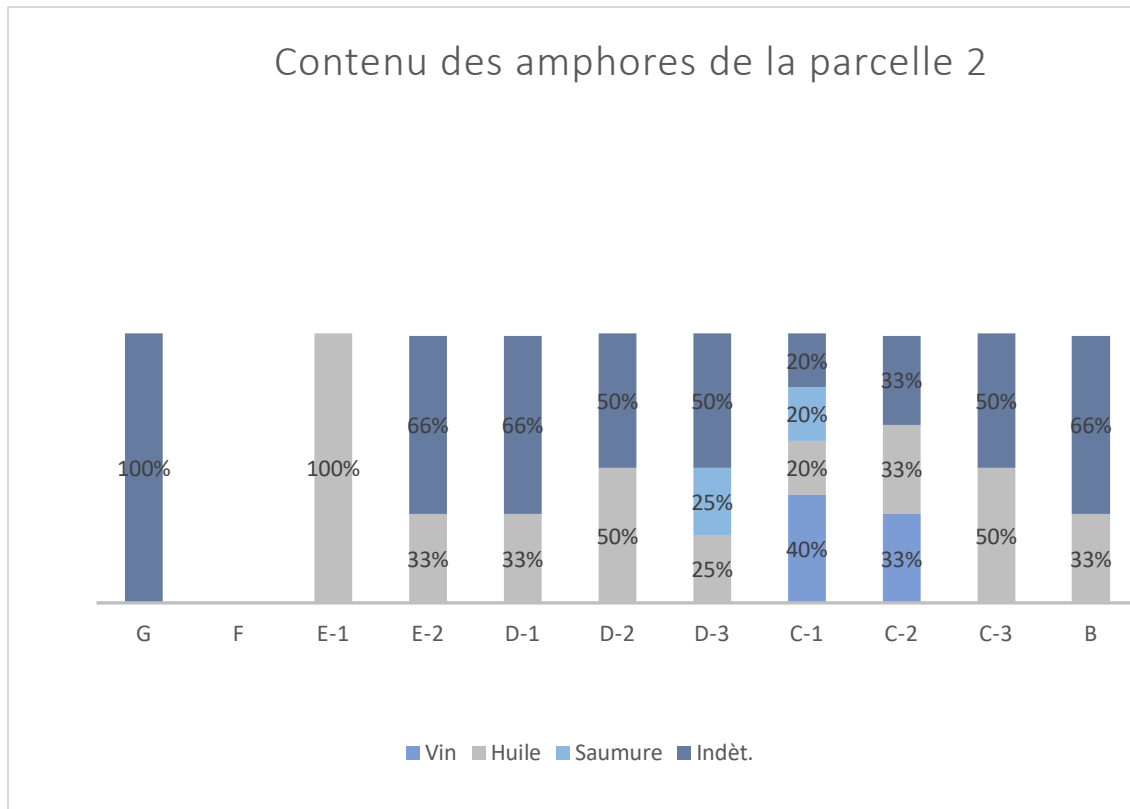
Fig. 18: Tableau synthétique de l'évolution des catégories céramiques de la parcelle 2.

Catégories	G	F	E-1	E-2	D-1	D-2	D-3	C-1	C-2	C-3	B
PARFIN A	6,65			4	2,83	0,97	0,42				
TSIT	6,65	14,28	4,76	8			0,42		0,51		
TSGM		4,76	4,76	8	26,41	19,9	23,6	7,2	4,09	4,3	3,7
TSGC		4,76	4,76	4	1,88	1,45	2,57	0,72	4,34	9,13	3,7
TSGE										1,3	1,85
TSAF										0,43	
RAEXR									0,25	0,43	
TNGC		4,76	4,76								
EIRP		4,76									
CP A	6,65	4,76		4	0,47	0,48	0,42	1,44	2,55	0,42	1,85
CP B	6,65				0,47	0,48					
TSI	6,65	14,28	19,04	36	31,13	31,55	23,6	26,66	29,41	3,04	7,4
TSITG		4,76	4,76	4	0,94	2,91	1,28	1,44		0,43	1,85
PGF		4,76	4,76	4	0,47	0,48	0,42	0,72		0,43	1,85
RALUIS					0,47	0,48	0,42	0,72	1,53	21,73	12,96
RAMET						0,48	0,42		0,25	8,26	3,7
RASABL						0,48			0,25	0,43	
RANOIR								0,72	0,25	0,86	3,7
RAMAT						0,48	1,28	2,17	0,25	7,82	1,85
EIR	6,65	4,76	9,52	4	0,47	0,48			2,04	1,3	1,85
EIRN					0,47		0,42	0,72	0,25	0,43	
MICAC				4	1,41	0,48	0,85	0,72	1,79	9,13	7,4
PGTN			4,76	4	5,18	0,48	4,2	10,14	18,6	9,13	7,4
PCCRU	6,65	4,76	4,76	4	2,35	2,91	0,42	1,44	1,53	1,73	1,85
PCMOR				4	0,47	0,48	0,42	0,72	1,79	1,3	3,7
PC	20	9,52	4,76	16	0,94	1,45	1,71	2,17	4,6	14,78	18,51
PG	33,35	28,57	28,57	20	24,05	32,03	36,05	52,17	16,36	9,56	14,81
PGGROS		4,76									3,7
	0>5%	5,1>10%	10,1>19,9%	20>100%							

3.3.3. Les amphores

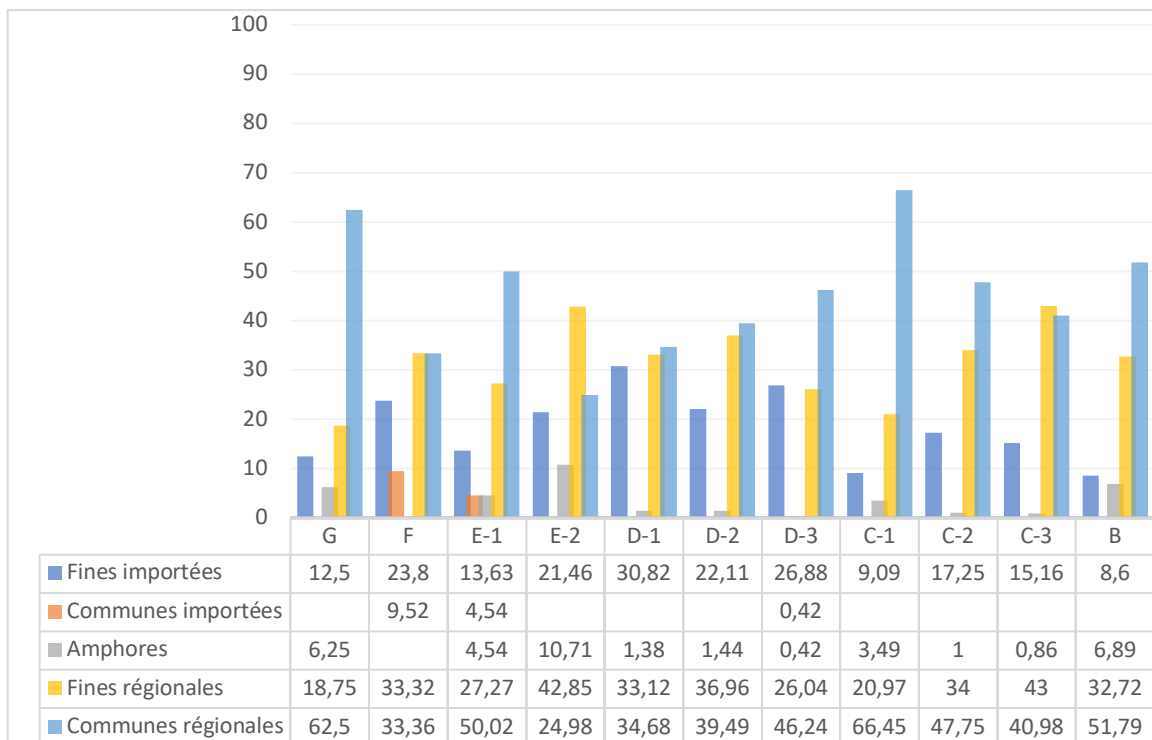
Fig. 19: Pourcentages des amphores (NMI exprimé en pourcents).





3.3.4. Évolution des groupes de production

Fig. 20: Évolution des groupes de production (NMI exprimés en pourcents).



3.3.5: Rapports entre quelques catégories choisies

Fig. 21.1: Évolution comparée des différentes catégories de sigillées (NMI exprimés en pourcents).

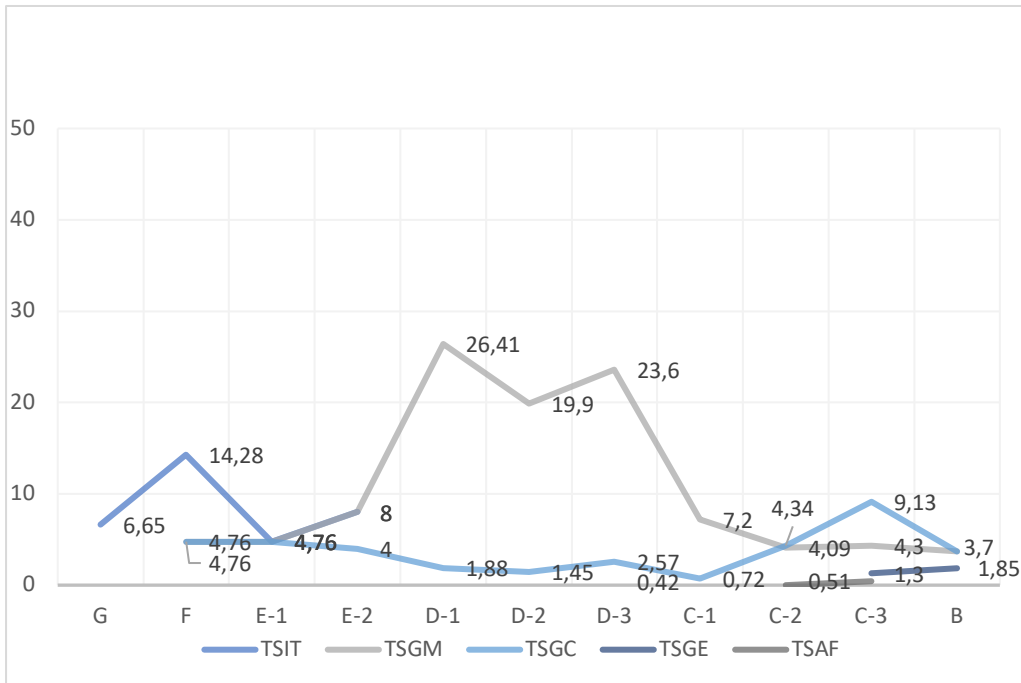


Fig. 21.2: Évolution comparée des sigillées et de leurs imitations (NMI exprimés en pourcents).

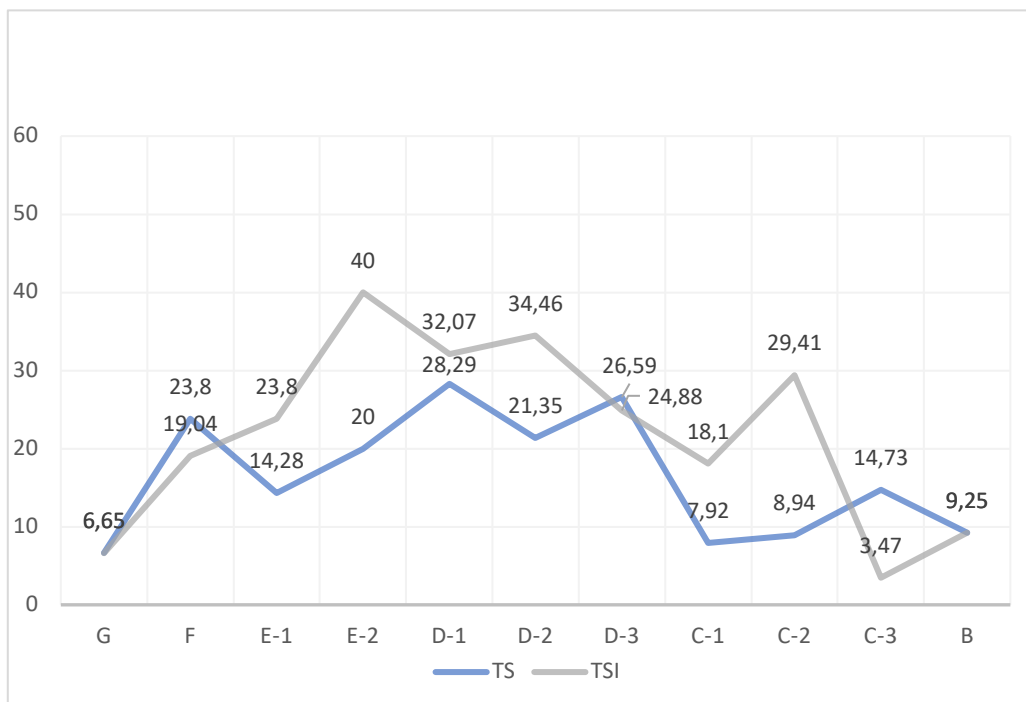


Fig. 21.3: Évolution comparée des sigillées, imitations de sigillées et revêtements argileux (NMI exprimés en pourcents).

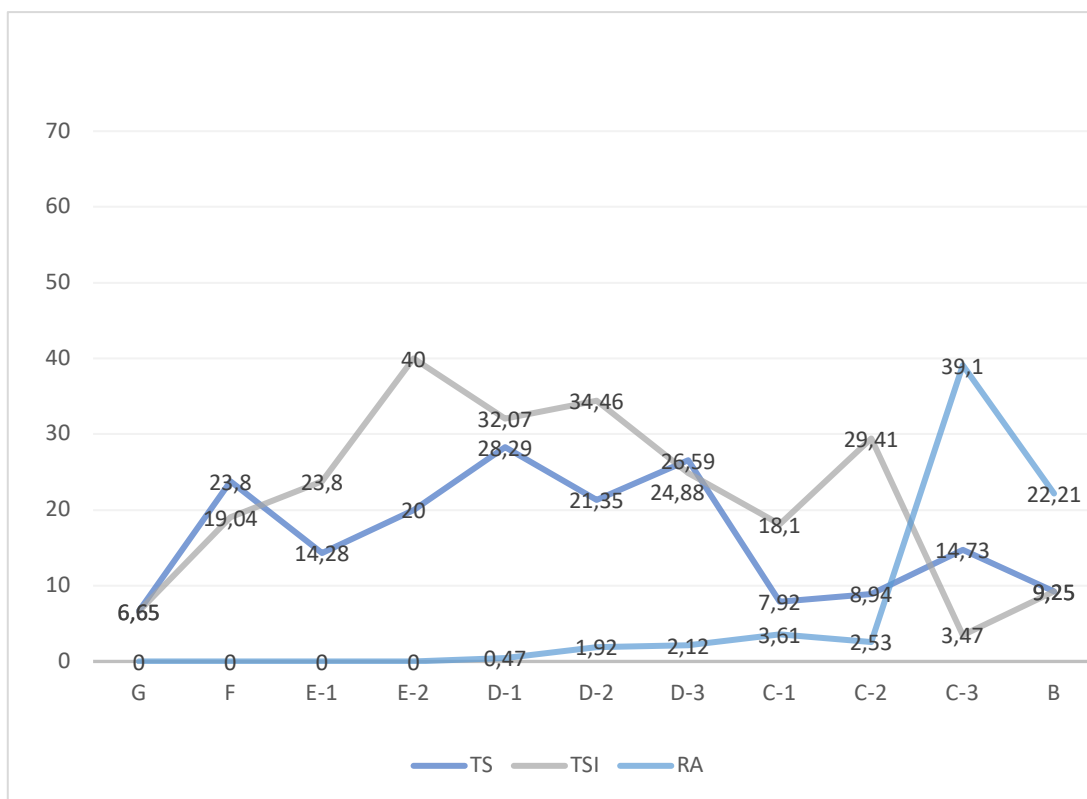


Fig. 21.4: Évolution comparée des revêtements argileux (NMI exprimés en pourcents).

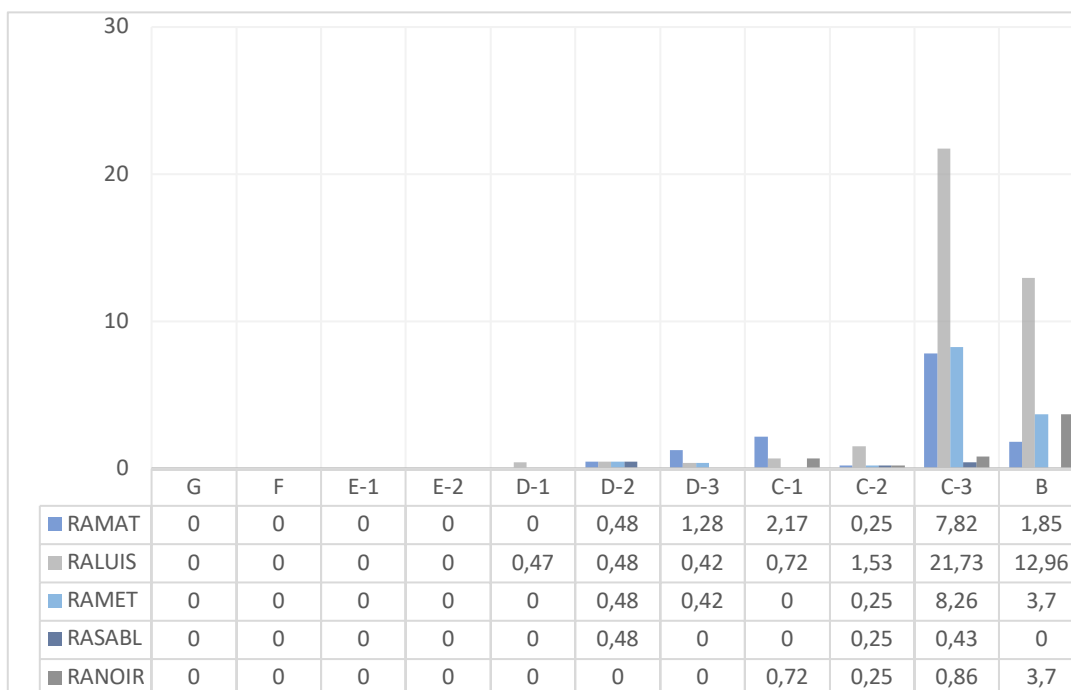
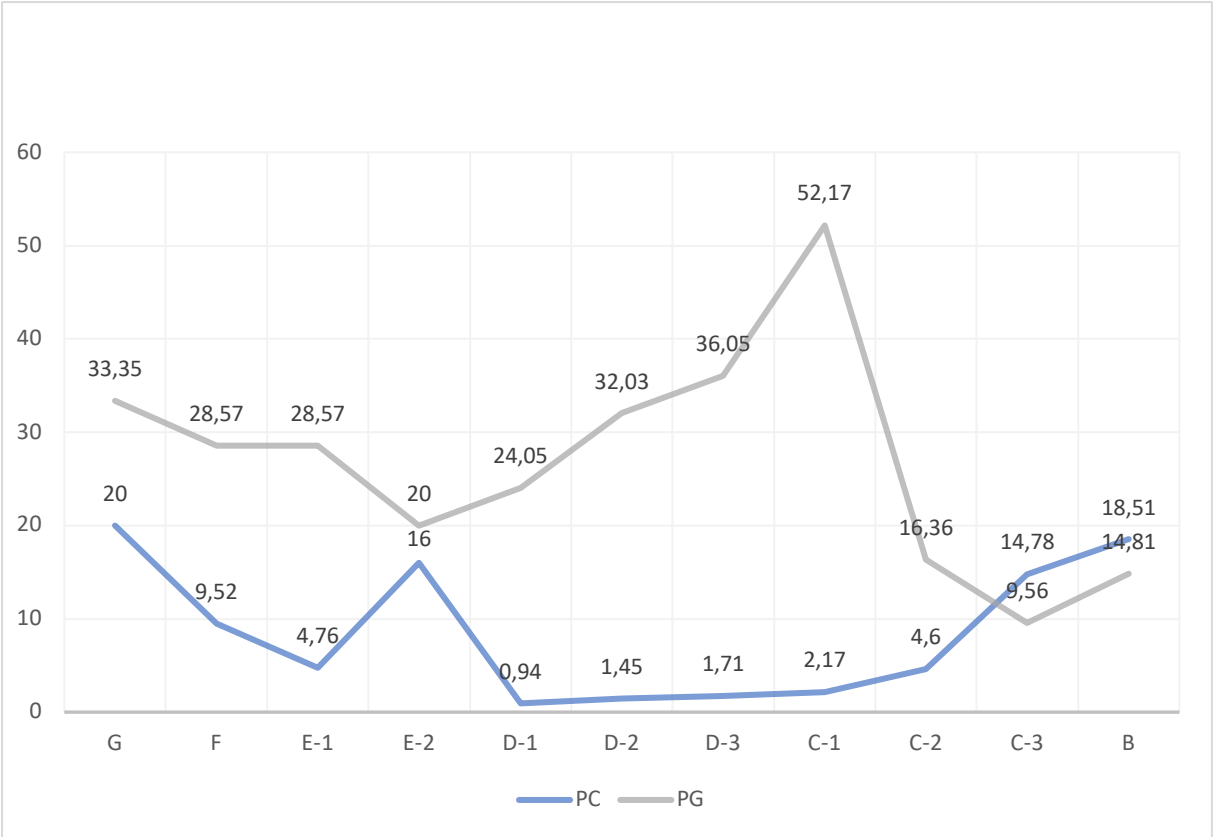


Fig. 21.5: Évolution comparée des communes oxydées et des communes réduites (NMI exprimés en pourcents).



3.3.6. Évolution des groupes morphologiques et de quelques formes

Fig. 22: Évolution des groupes morphologiques (NMI exprimés en pourcents).

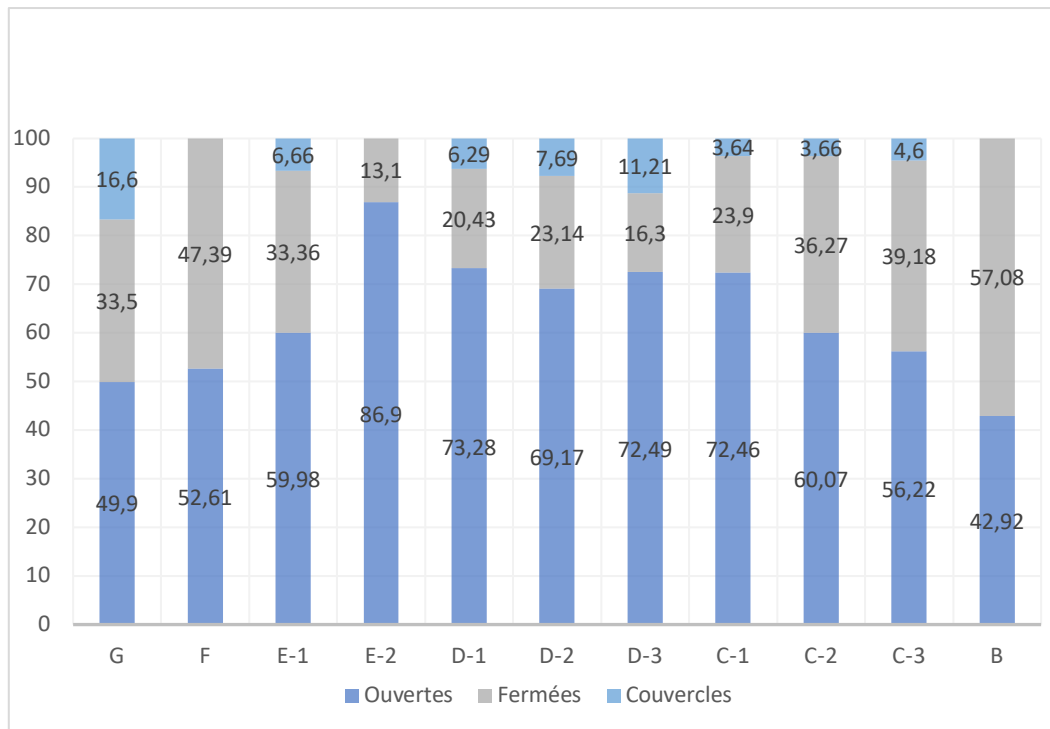
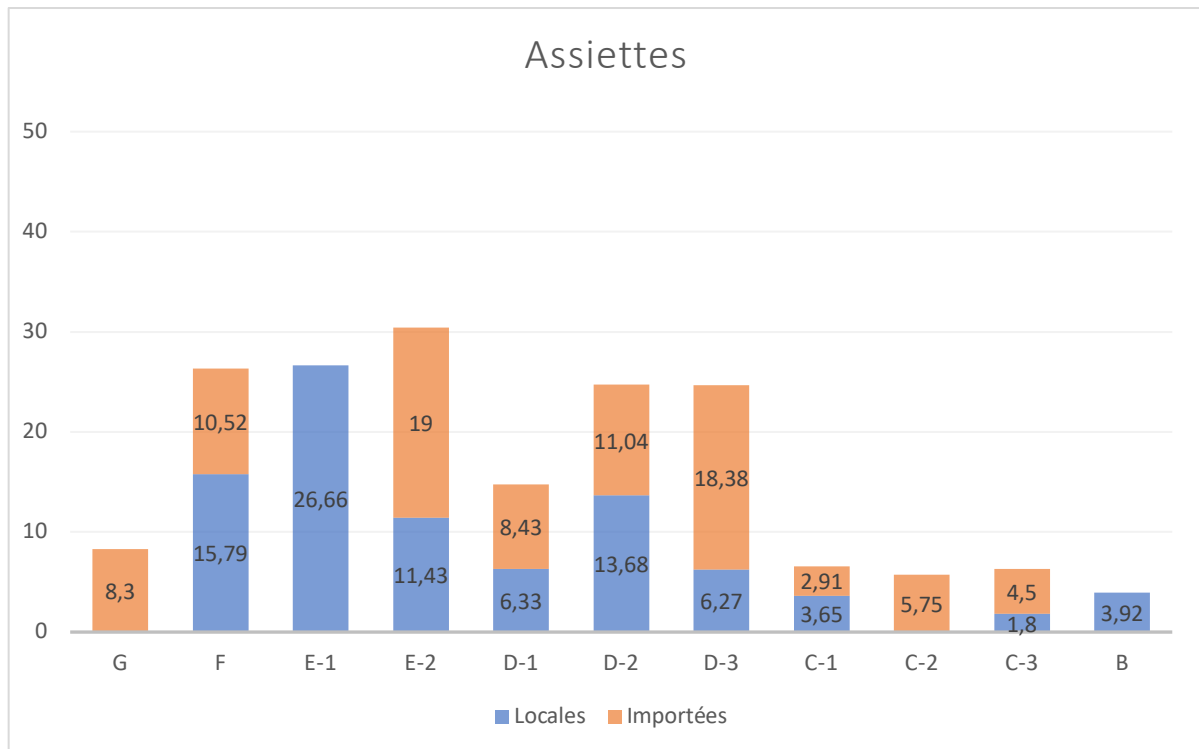
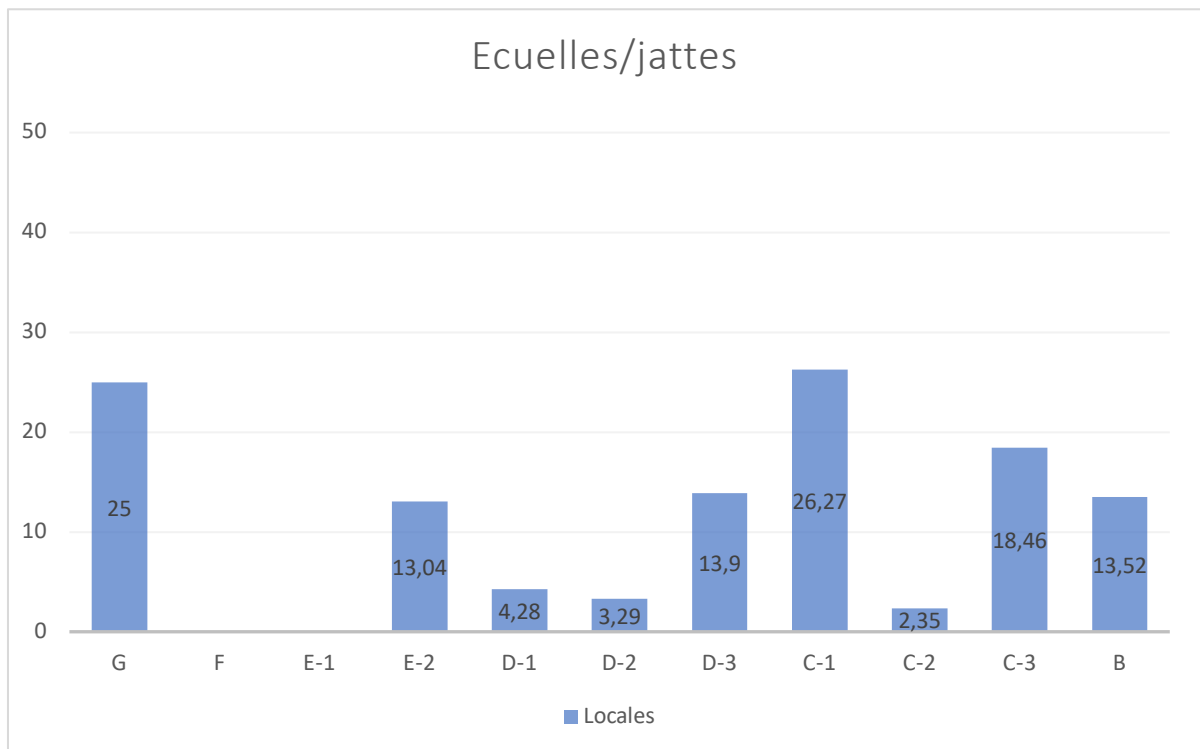
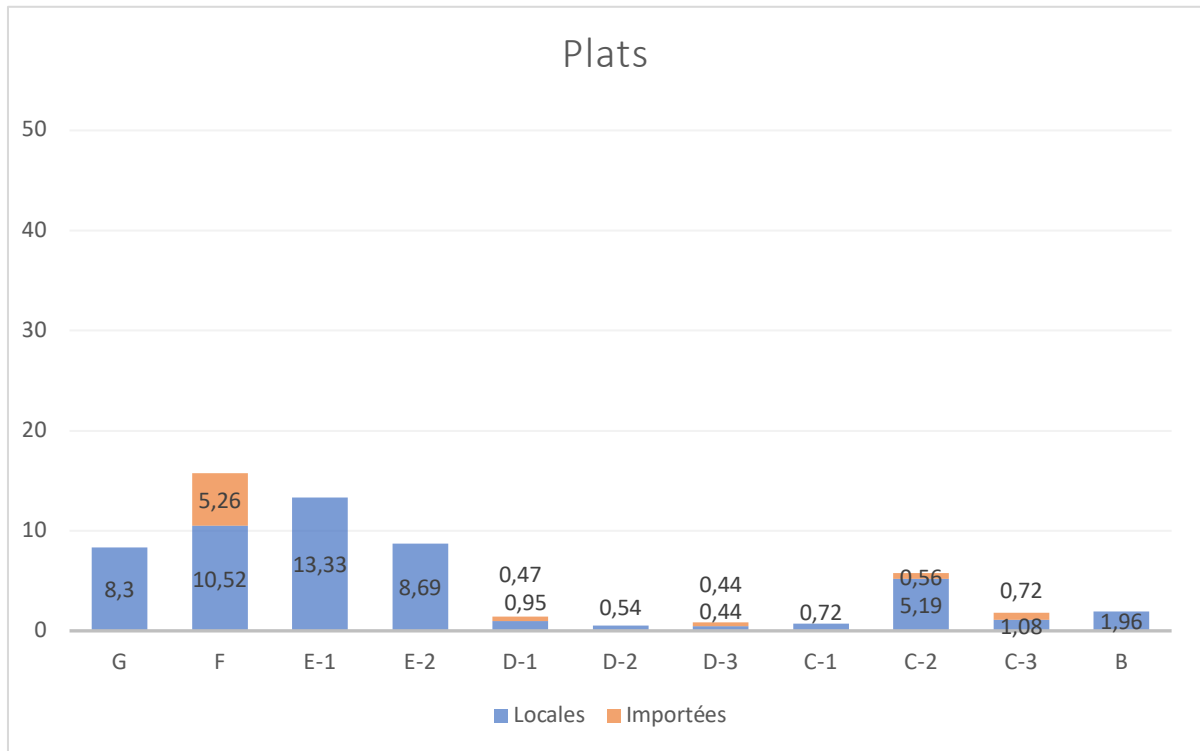
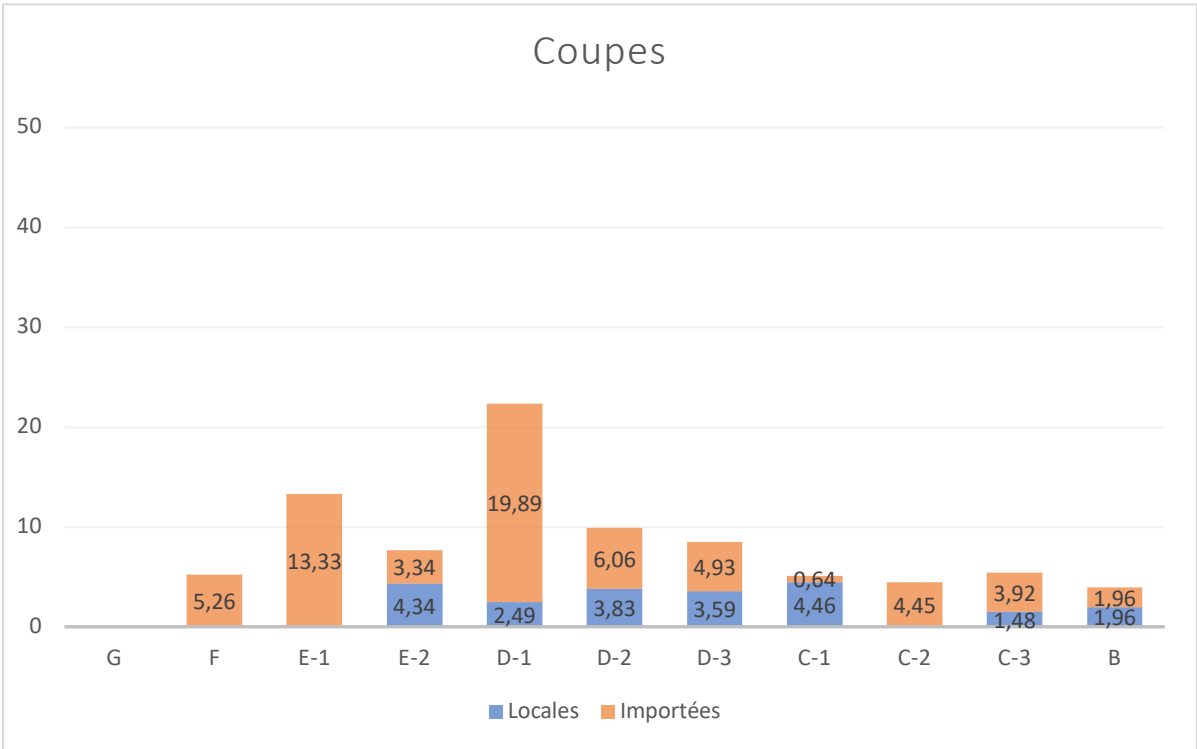
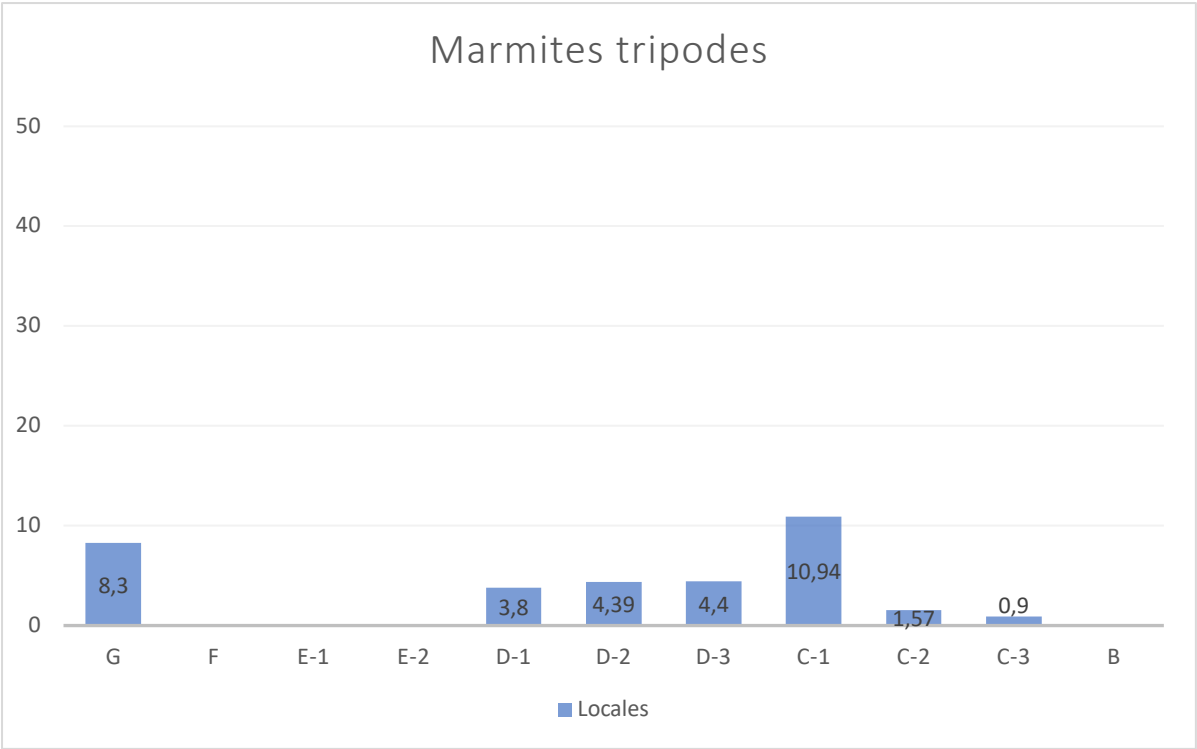
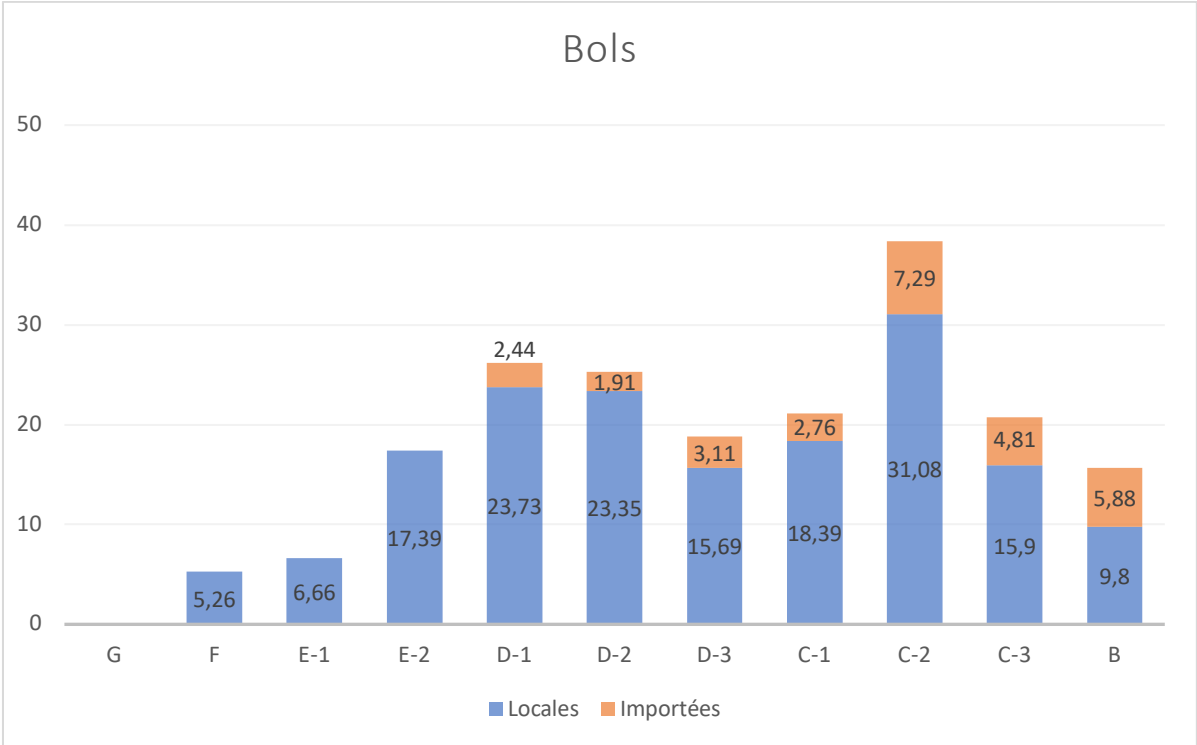
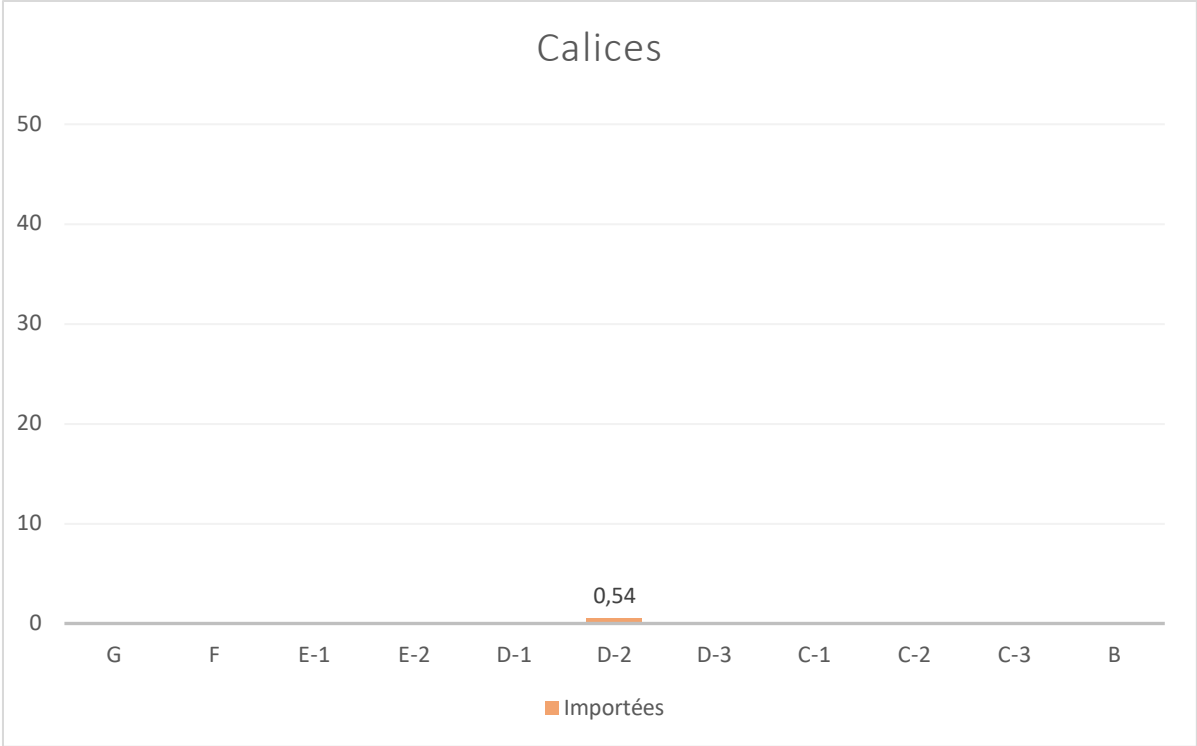


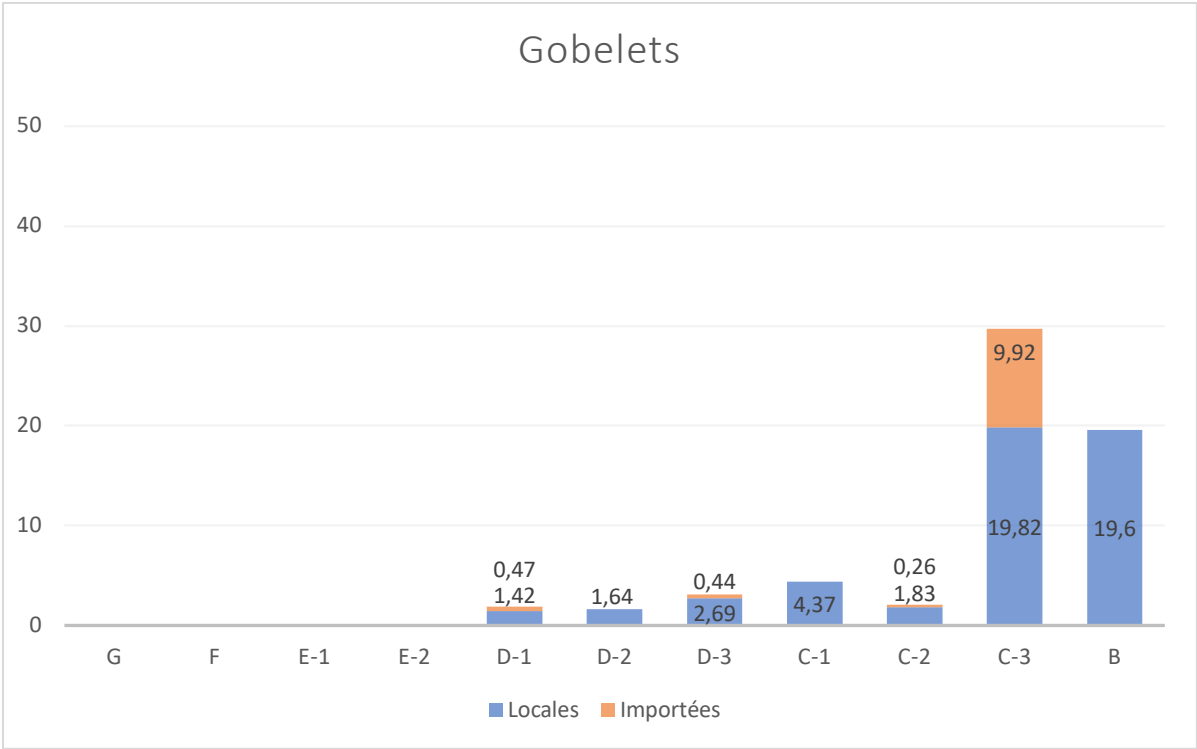
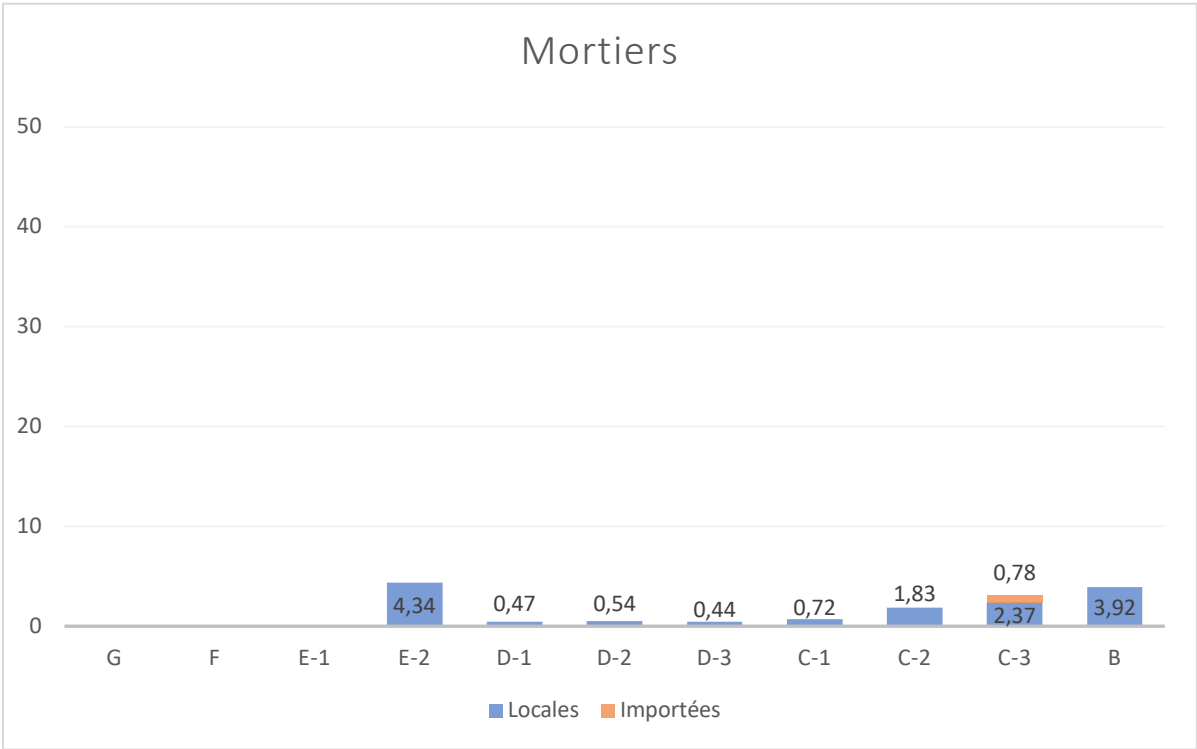
Fig. 23: Évolution des proportions des formes (NMI exprimés en pourcents).

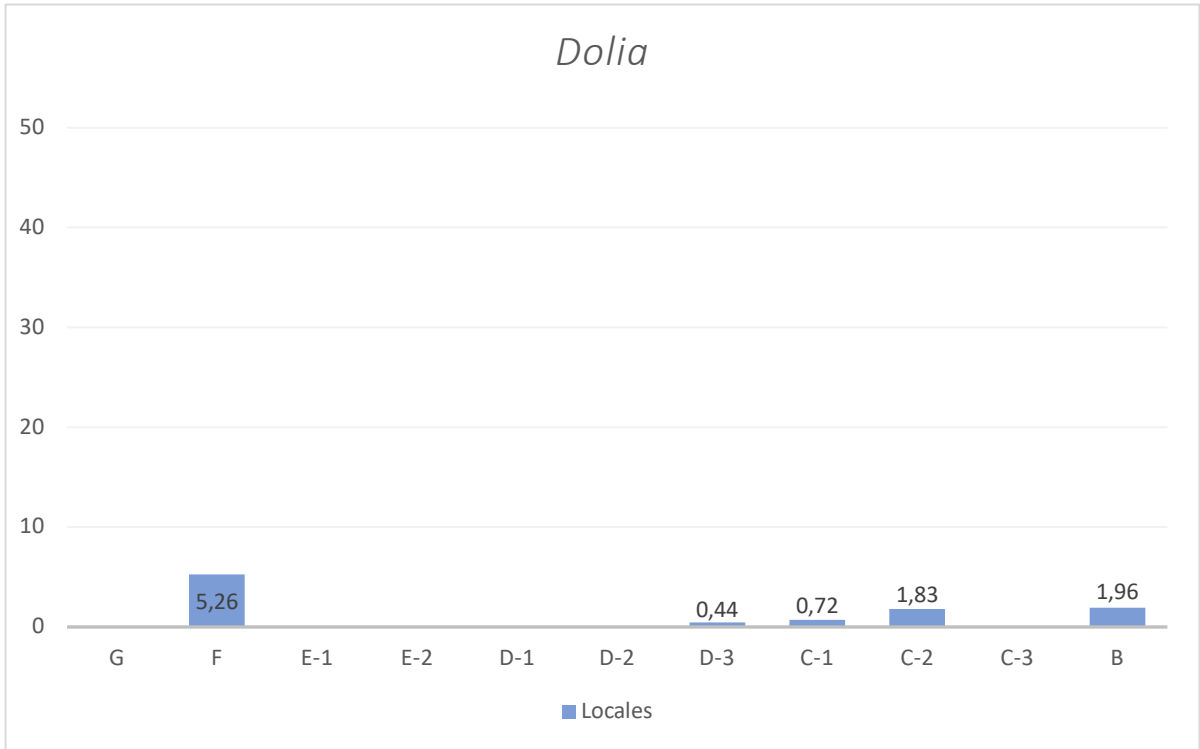
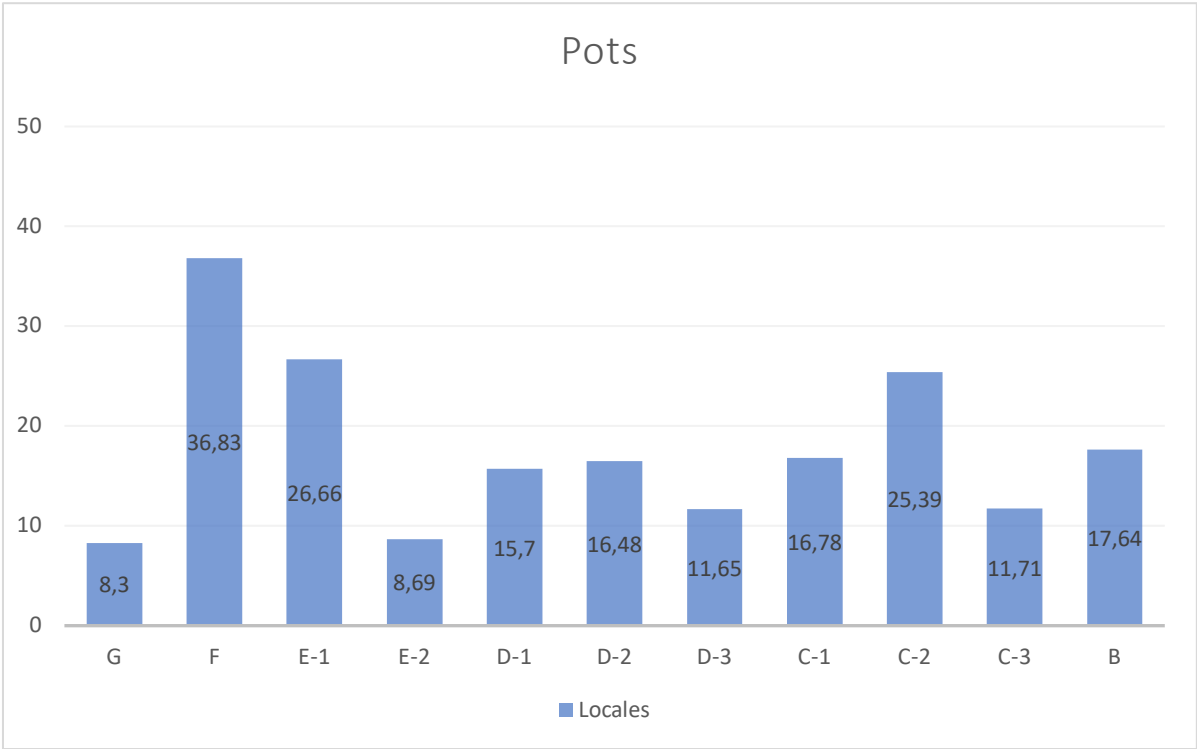


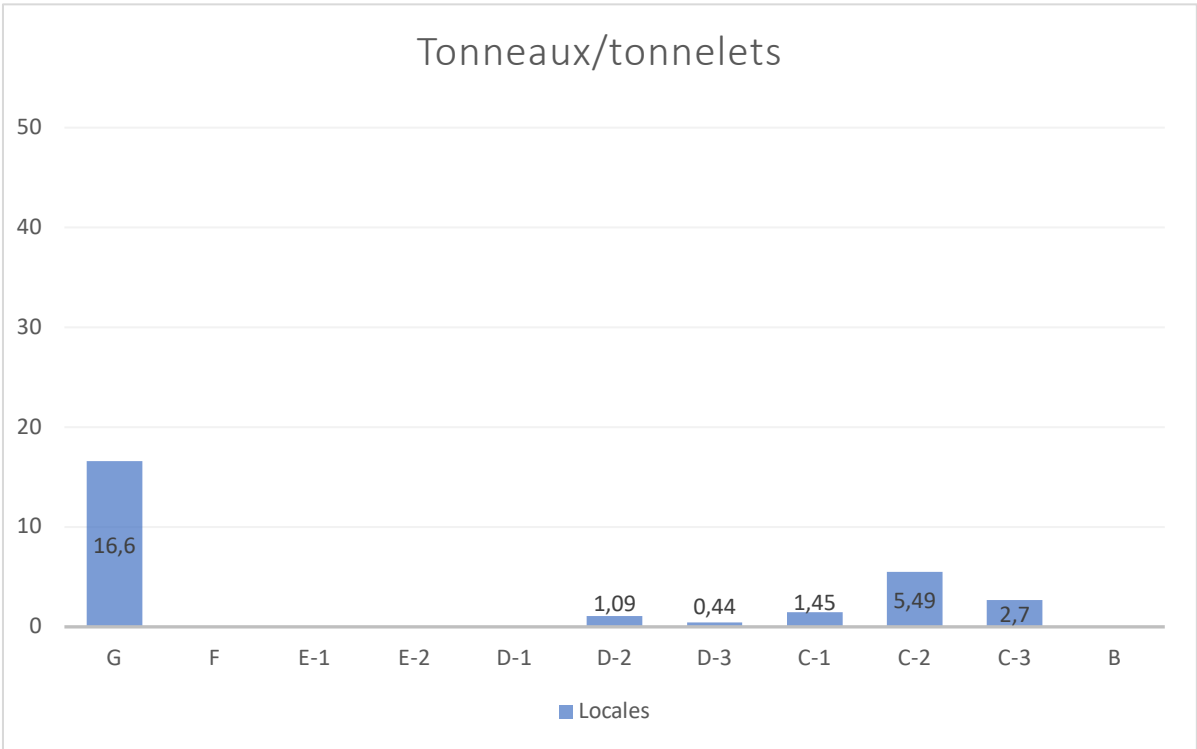
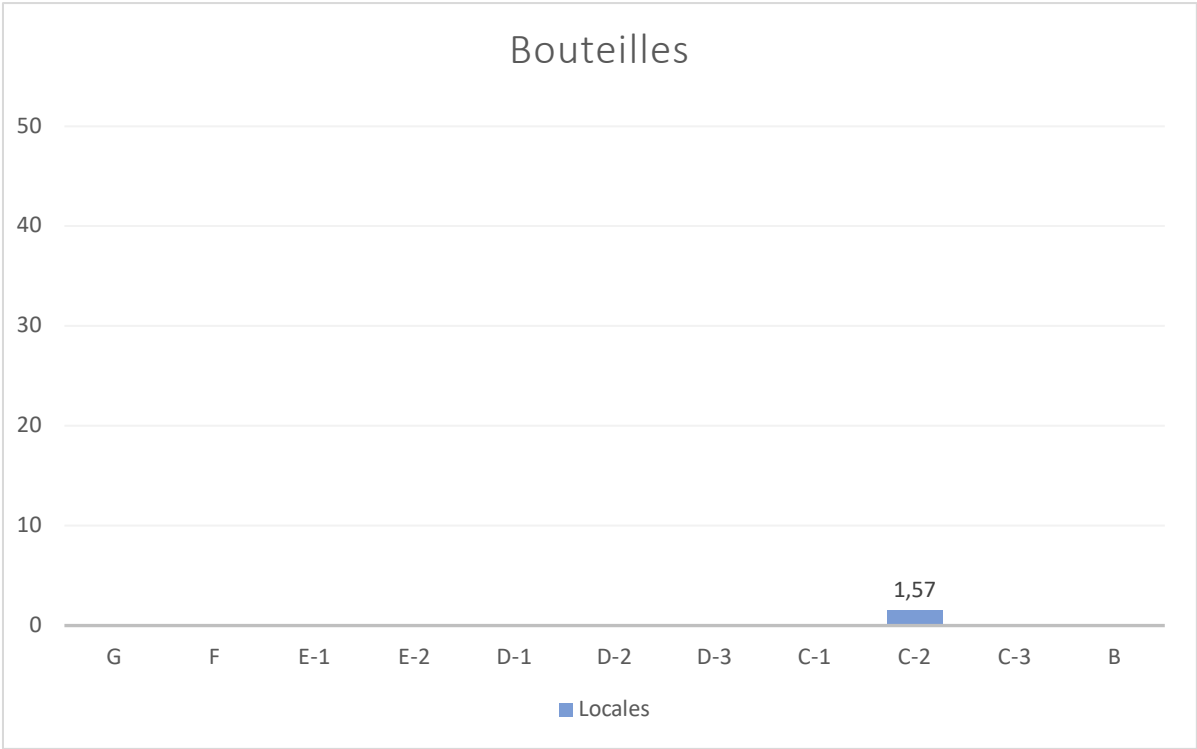


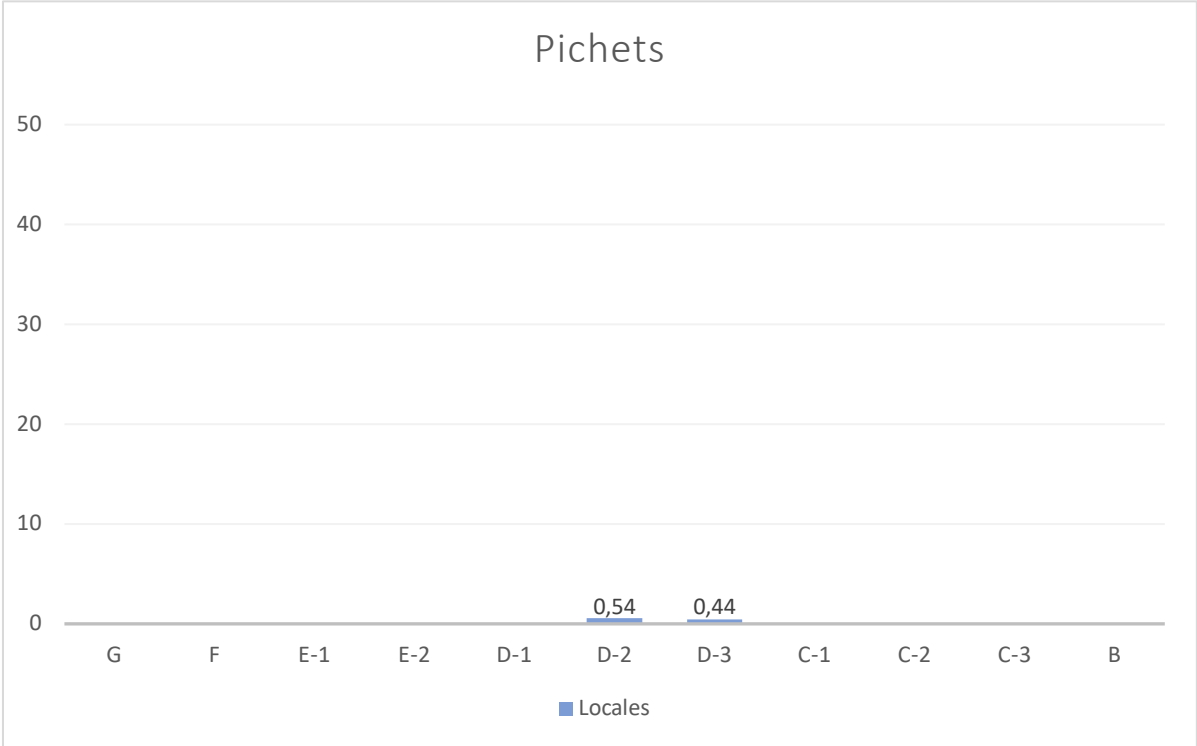
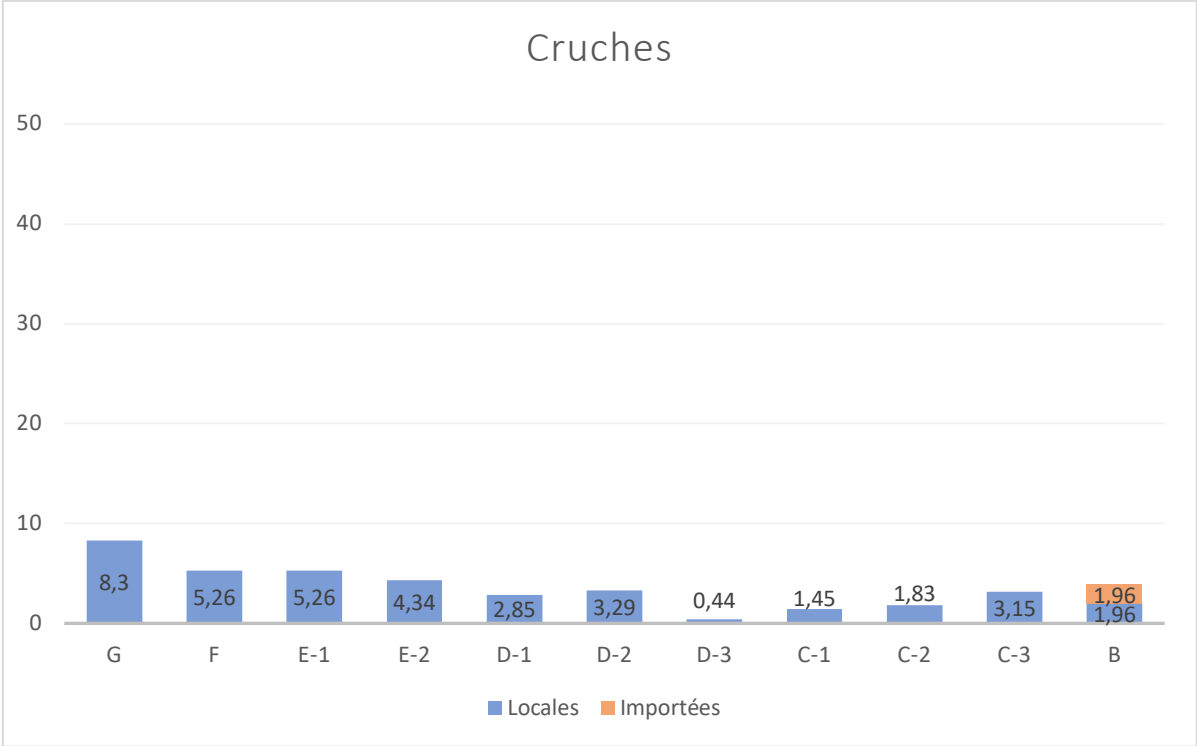












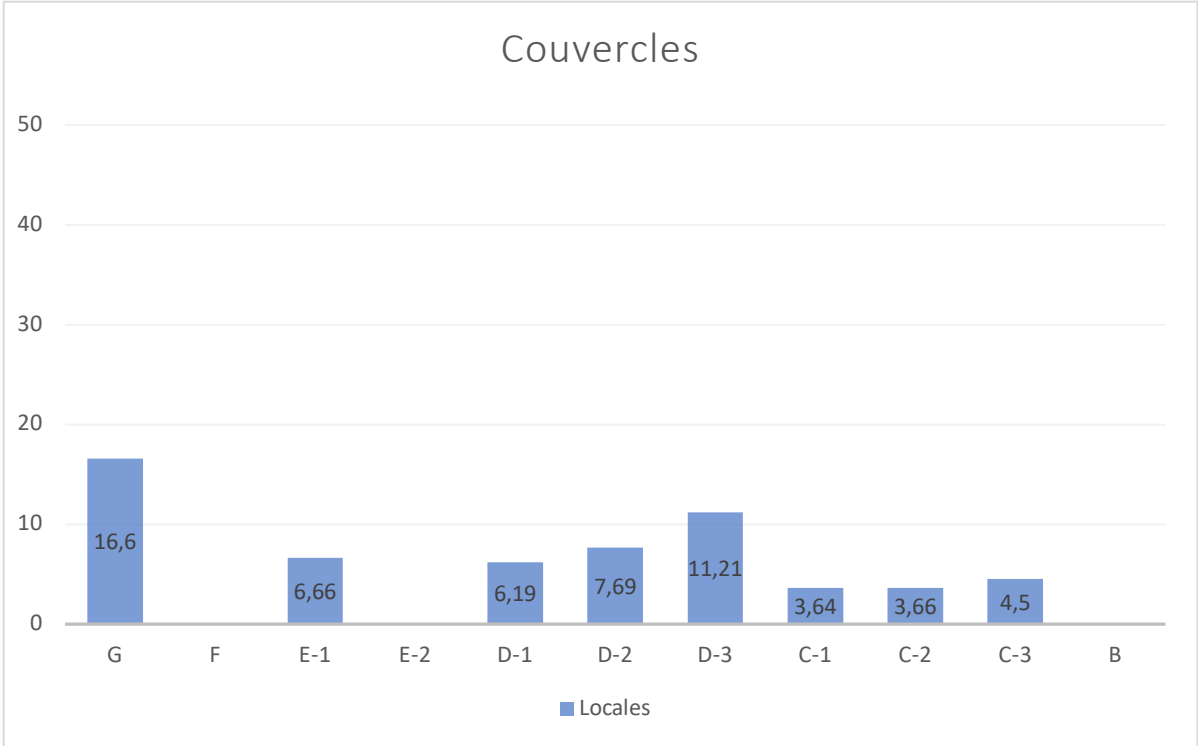


Fig. 24: Tableau synthétique de l'évolution des formes de la parcelle 2.

Formes	G	F	E-1	E-2	D-1	D-2	D-3	C-1	C-2	C-3	B
Assiettes	8,3	16,31	26,66	30,43	14,76	24,72	24,65	6,56	5,75	6,3	3,92
Plats	8,3	15,78	13,33	8,69	1,42	0,54	0,88	0,72	5,75	1,8	1,96
Ecuelles/jattes	25			13,04	4,28	3,29	13,9	26,27	2,35	18,46	13,52
Marmites	8,3				3,8	4,39	4,4	10,94	1,57	0,9	
Coupes		5,26	13,33	7,64	22,38	9,89	8,52	5,1	4,45	5,4	3,92
Calices						0,54					
Bols		5,26	6,66	17,39	26,17	25,26	28,8	21,15	38,37	20,71	15,68
Mortiers				4,34	0,47	0,54	0,44	0,72	1,83	1,15	3,92
Gobelets					1,89	1,64	3,13	4,37	2,09	29,74	19,6
Pots	8,3	36,83	26,66	8,69	15,7	16,48	11,65	16,78	25,39	11,71	17,64
<i>Dolia</i>	5,26						0,44	0,72	1,83		1,96
Bouteilles									1,57		
Tonnelets						1,09	0,44	1,45	5,49	2,7	
Cruches	16,6	8,3	5,26	4,34	2,85	3,29	0,44	1,45	1,83	3,15	3,92
Pichets						0,54	0,44				
Couvercles	16,6		6,66		6,19	7,69	11,21	3,64	3,66	4,5	
	0>5%	5,1>10%	10,1>19,9%	20>100%							

Fig. 25.1: Évolution comparée des assiettes et des écuelles.

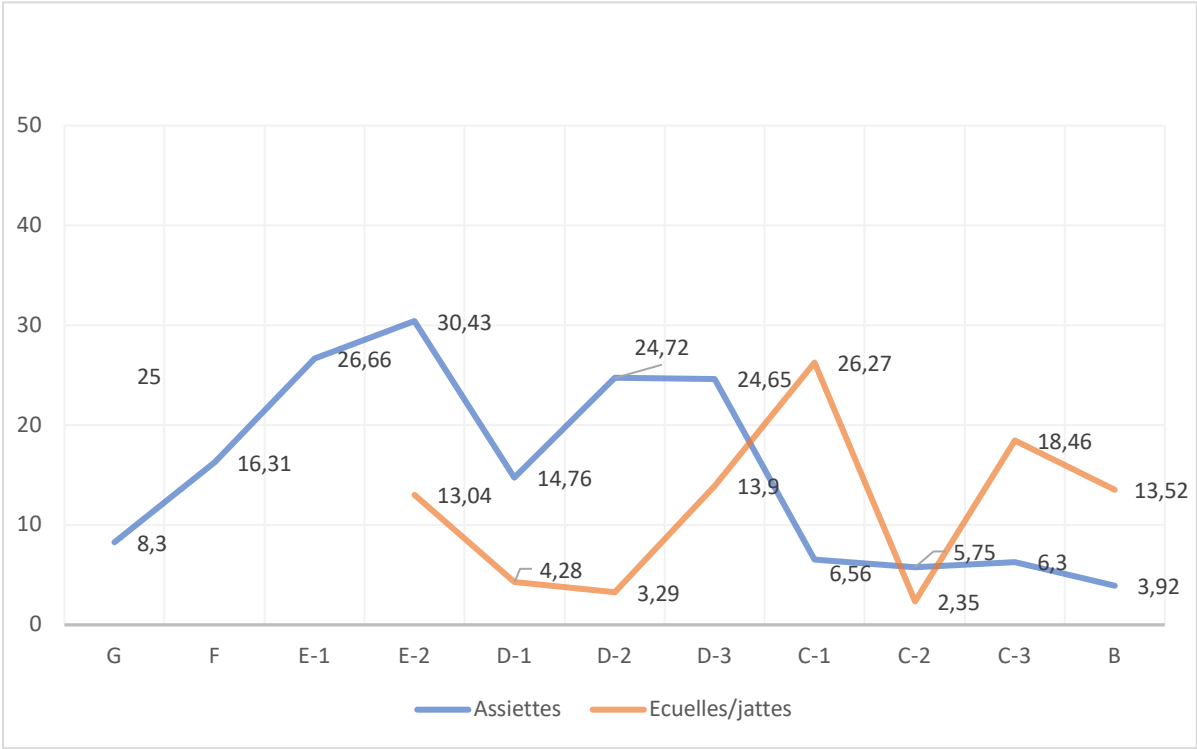
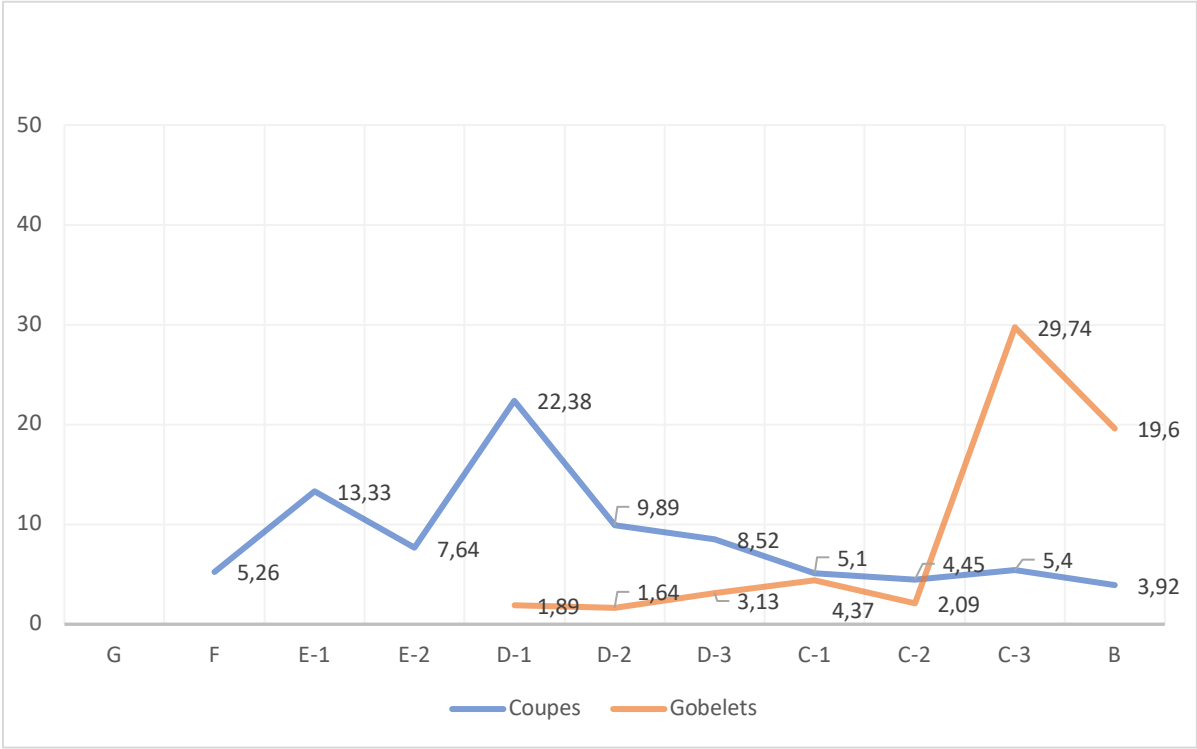


Fig. 25.2: Évolution comparée des coupes et des gobelets.



4. Céramique et fonction des locaux

4.1.2. Définition groupes de catégories et catégories fonctionnelles

Fig. 26: Catégories fonctionnelles céramiques adoptées pour l'analyse des espaces de la parcelle 2.

Fonction	Formes
Consommation liquide individuelle	Gobelets, coupes profondes à bord droit
Consommation liquide et semi-liquide individuelle	Écuelles/jattes et bols fins locaux
Service liquide commun/stockage	Cruches, bouteilles, tonneaux/tonnelets
Service liquide et semi-liquide commun	Assiettes, plats, bols importés, coupes peu profondes à bord déversé
Préparation	Mortiers, bols de catégories communes
Cuisson	Marmites, plats à engobe interne, pots en PG et PC ovoïdes, sans décors (sauf peignés), bols à marli et micacés
Stockage	Autres pots, <i>dolia</i>
Fermeture	Couvercles, jetons, opercules
Transport	Amphores

4.2. Analyse fonctionnelle

4.2.1. Période D-1 (100/150 ap. J.-C.)

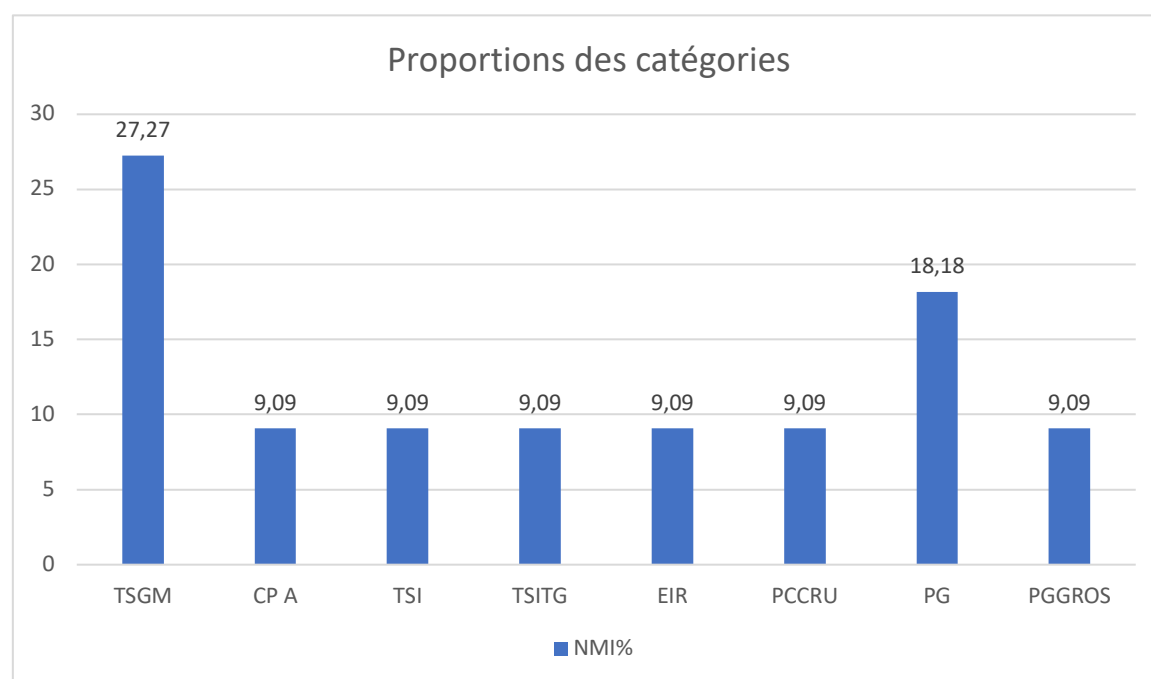
Fig. 27: Local 15 : pièce de séjour.

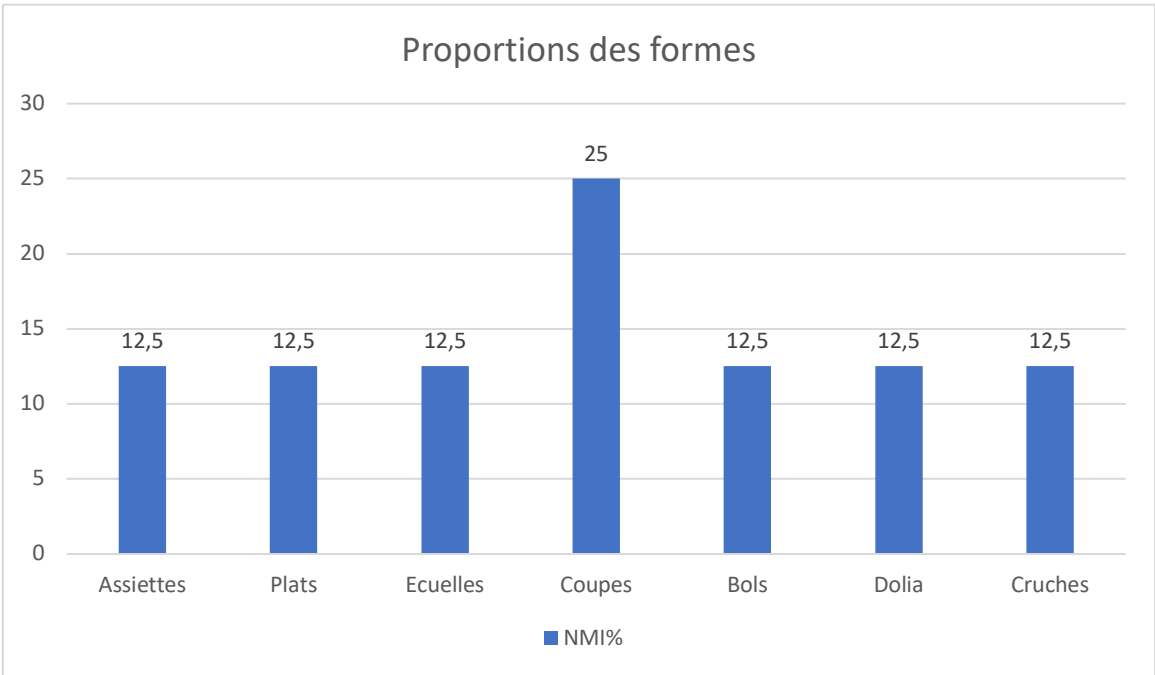
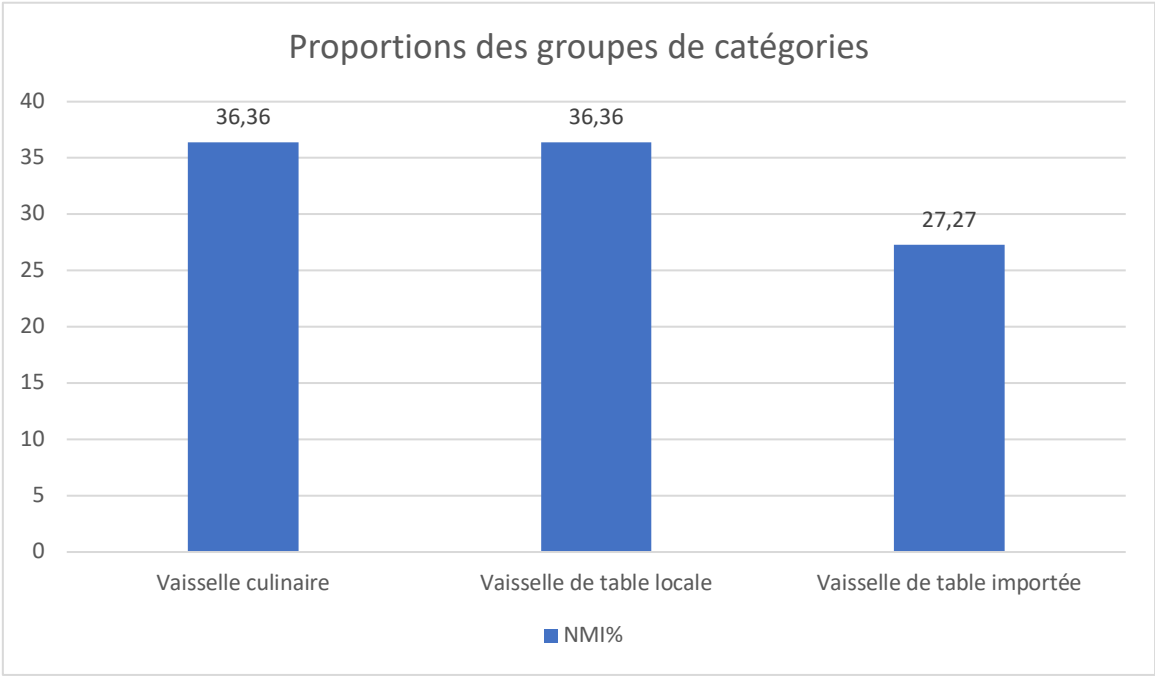
NMI	Catégories	%
3	TSGM	27,27
1	CP A	9,09
1	TSI	9,09
1	TSITG	9,09
1	EIR	9,09
1	PCCRU	9,09
2	PG	18,18
1	PGGROS	9,09
11		100%

NMI	Catégories	%
4	Vaisselle culinaire	36,36
4	Vaisselle de table locale	36,36
3	Vaisselle de table importée	27,27
11		100%

NMI	Formes	%
1	Assiettes	12,5
1	Plats	12,5
1	Ecuelles	12,5
2	Coupes	25
1	Bols	12,5
1	<i>Dolia</i>	12,5
1	Cruches	12,5
8		100%

NMI	Fonctions	%
0	Consommation liquide individuel	0
1	Consommation solide+ semi-liquide ind.	12,5
1	Service liquide commun/stockage	12,5
4	Service solide+semi-liquide commun	50
0	Préparation	0
1	Cuisson	12,5
1	Stockage	12,5
0	Fermeture	0
0	Transport	0
8		100%





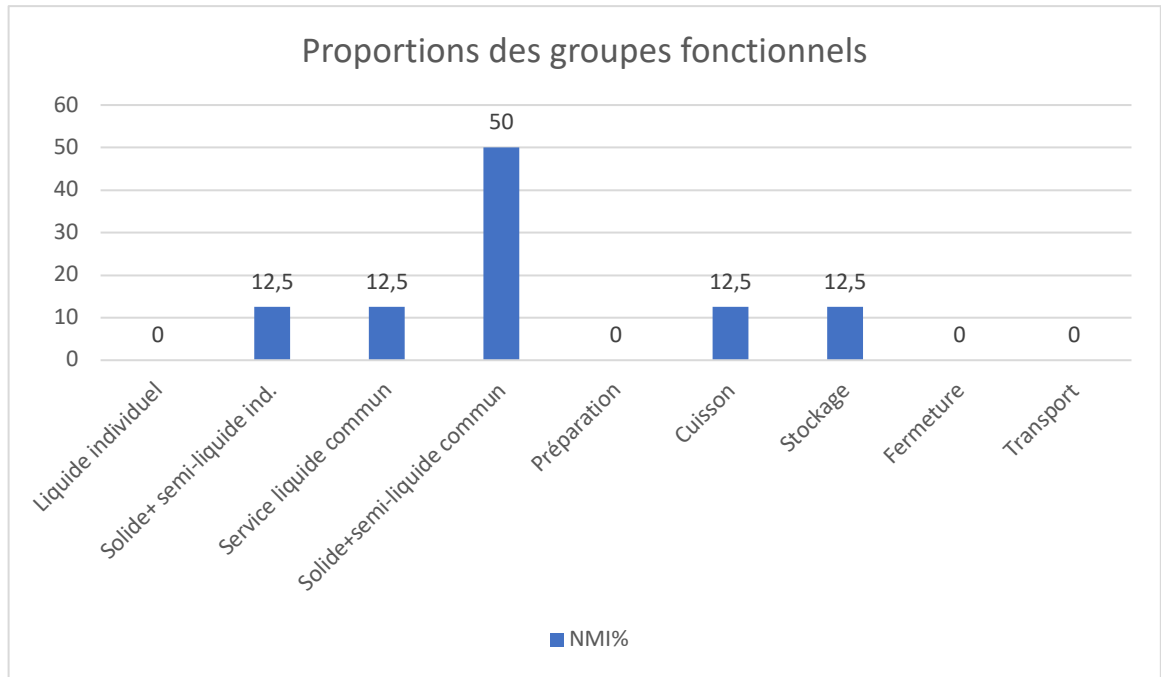


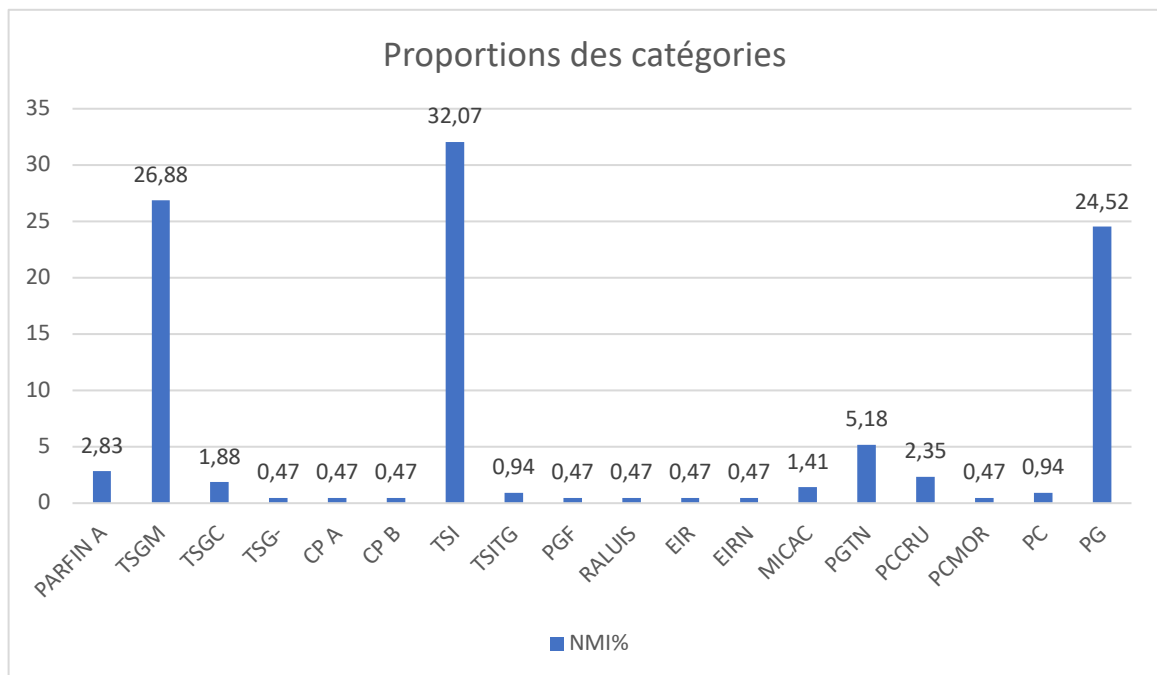
Fig. 28: Local 16: atelier artisanal (boucherie, artisanat culinaire ?).

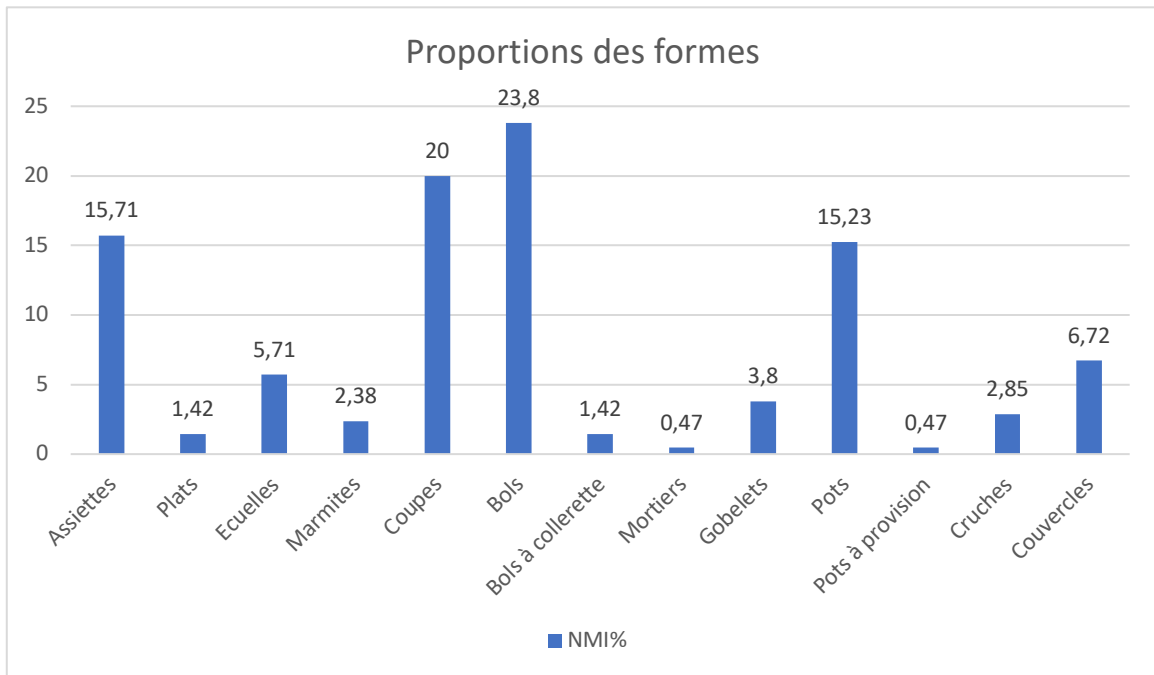
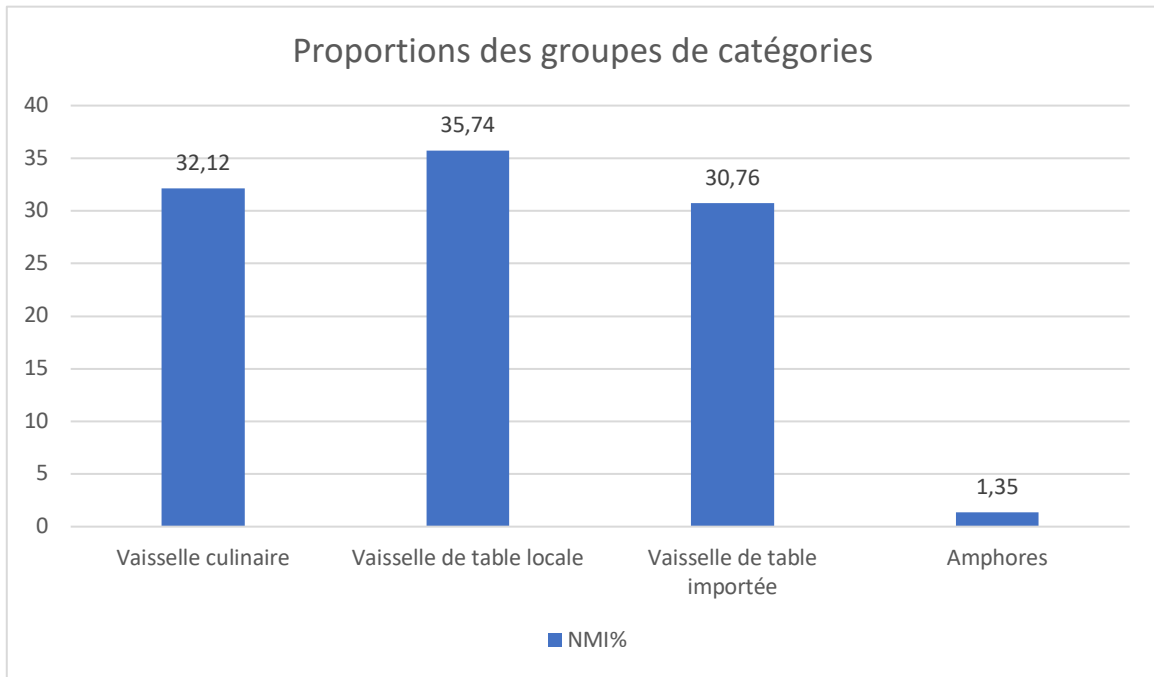
NMI	Catégories	%
6	PARFIN A	2,83
57	TSGM	26,88
4	TSGC	1,88
1	TSG-	0,47
1	CP A	0,47
1	CP B	0,47
68	TSI	32,07
2	TSITG	0,94
1	PGF	0,47
1	RALUIS	0,47
1	EIR	0,47
1	EIRN	0,47
3	MICAC	1,41
11	PGTN	5,18
5	PCCRU	2,35
1	PCMOR	0,47
2	PC	0,94
52	PG	24,52
218		100%

NMI	Catégories	%
71	Vaisselle culinaire	32,12
79	Vaisselle de table locale	35,74
68	Vaisselle de table importée	30,76
3	Amphores	1,35
221		100%

NMI	Formes	%
33	Assiettes	15,71
3	Plats	1,42
12	Ecuelles	5,71
5	Marmites	2,38
42	Coupes	20
50	Bols	23,8
3	Bols à colerette	1,42
1	Mortiers	0,47
8	Gobelets	3,8
32	Pots	15,23
1	Pots à provision	0,47
6	Cruches	2,85
14	Couvercles	6,72
210		100%

NMI	Fonctions	%
47	Consommation liquide individuel	18,8
55	Consommation solide+ semi-liquide ind.	22
6	Service liquide commun/stockage	2,4
82	Service solide+semi-liquide commun	32,8
3	Préparation	1,2
16	Cuisson	6,4
24	Stockage	9,6
14	Fermeture	5,6
3	Transport	1,4
250		100%





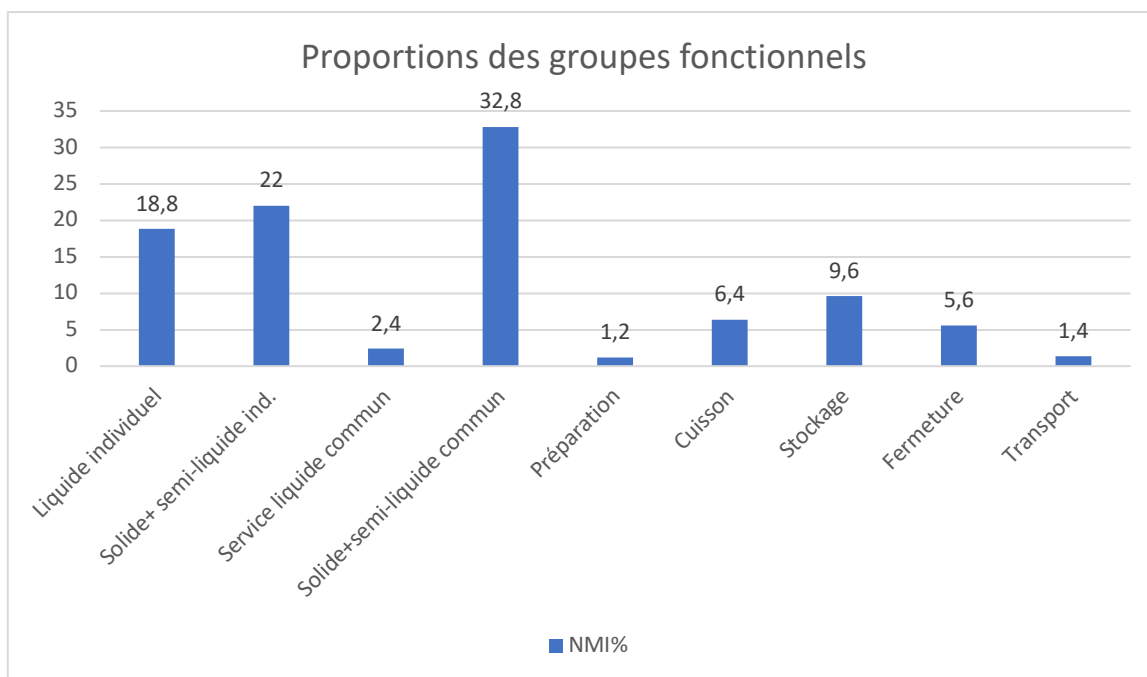


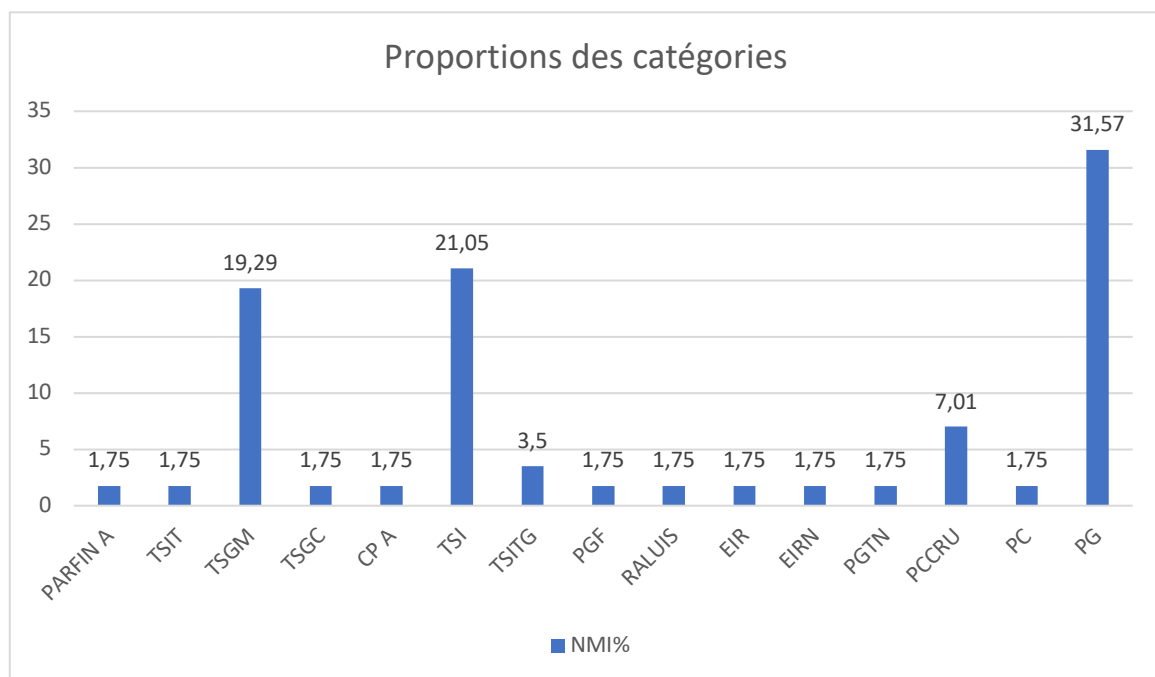
Fig. 29: Local 17: cuisine/zone de stockage.

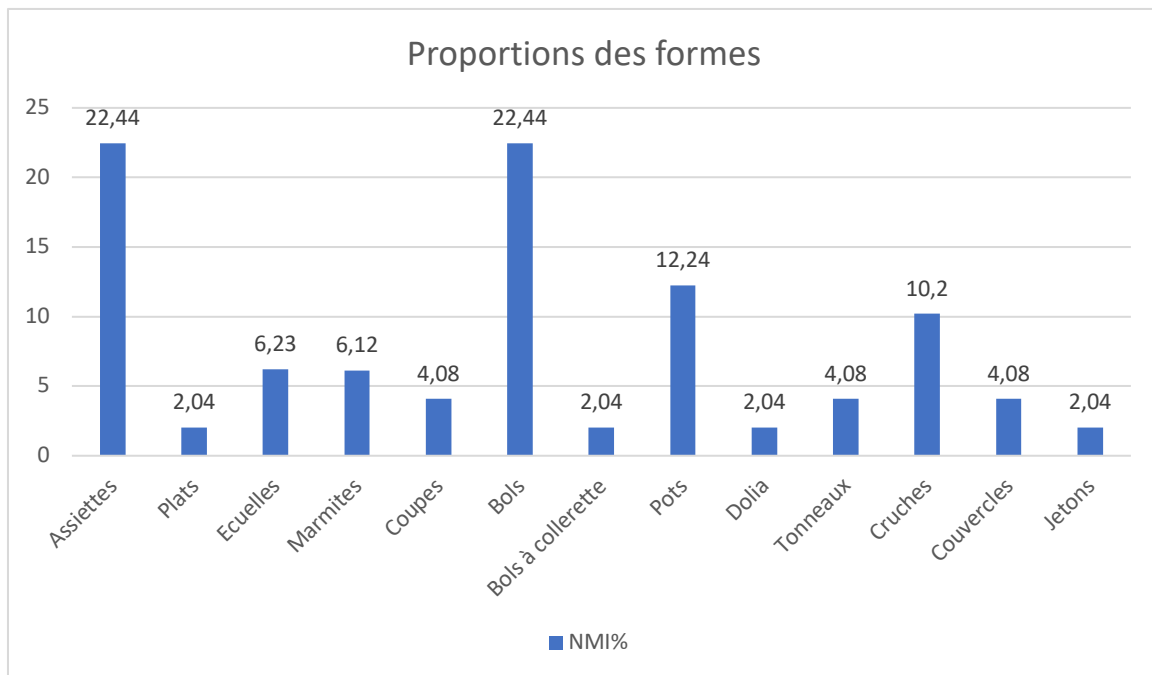
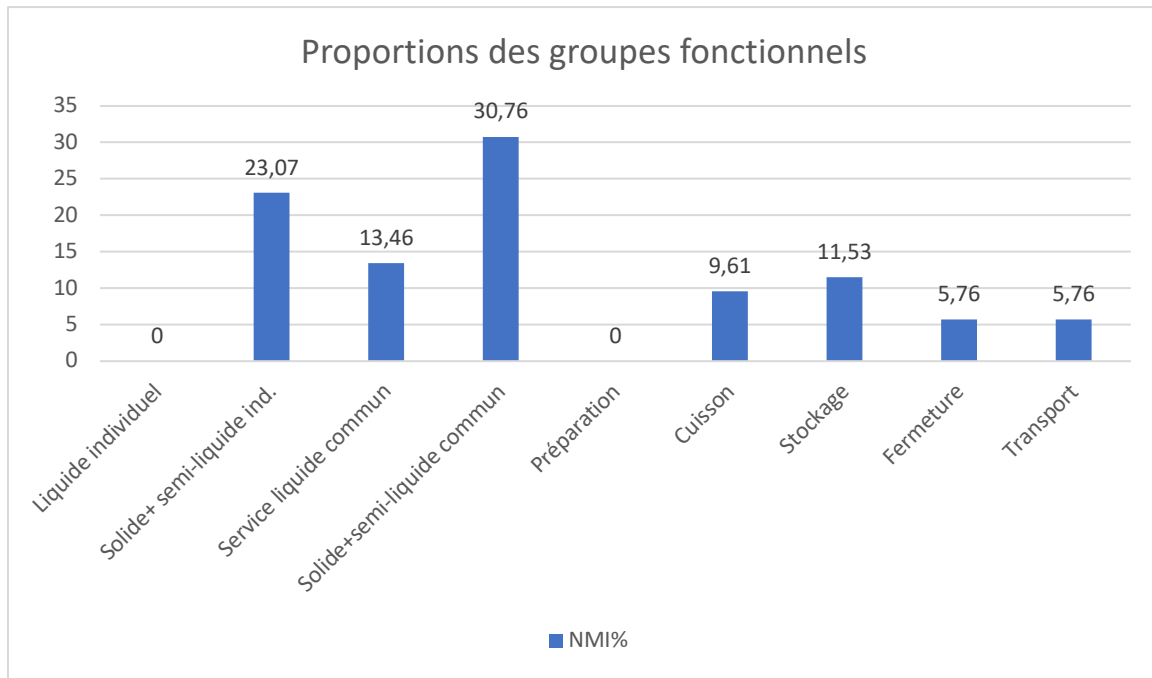
NMI	Catégories	%
1	PARFIN A	1,75
1	TSIT	1,75
11	TSGM	19,29
1	TSGC	1,75
1	CP A	1,75
12	TSI	21,05
2	TSITG	3,5
1	PGF	1,75
1	RALUIS	1,75
1	EIR	1,75
1	EIRN	1,75
1	PGTN	1,75
4	PCCRU	7,01
1	PC	1,75
18	PG	31,57
57		100%

NMI	Catégories	%
22	Vaisselle culinaire	36,66
21	Vaisselle de table locale	35
14	Vaisselle de table importée	23,33
3	Amphores	5
60		100%

NMI	Formes	%
11	Assiettes	22,44
1	Plats	2,04
3	Ecuelles	6,23
3	Marmites	6,12
2	Coupes	4,08
11	Bols	22,44
1	Bols à collerette	2,04
6	Pots	12,24
1	<i>Dolia</i>	2,04
2	Tonneaux	4,08
5	Cruches	10,2
2	Couvercles	4,08
1	Jetons	2,04
49		100%

NMI	Fonctions	%
0	Consommation liquide individuel	0
12	Consommation solide+ semi-liquide ind.	23,07
7	Service liquide commun/stockage	13,46
16	Service solide+semi-liquide commun	30,76
0	Préparation	0
5	Cuisson	9,61
6	Stockage	11,53
3	Fermeture	5,76
3	Transport	5,76
52		100%





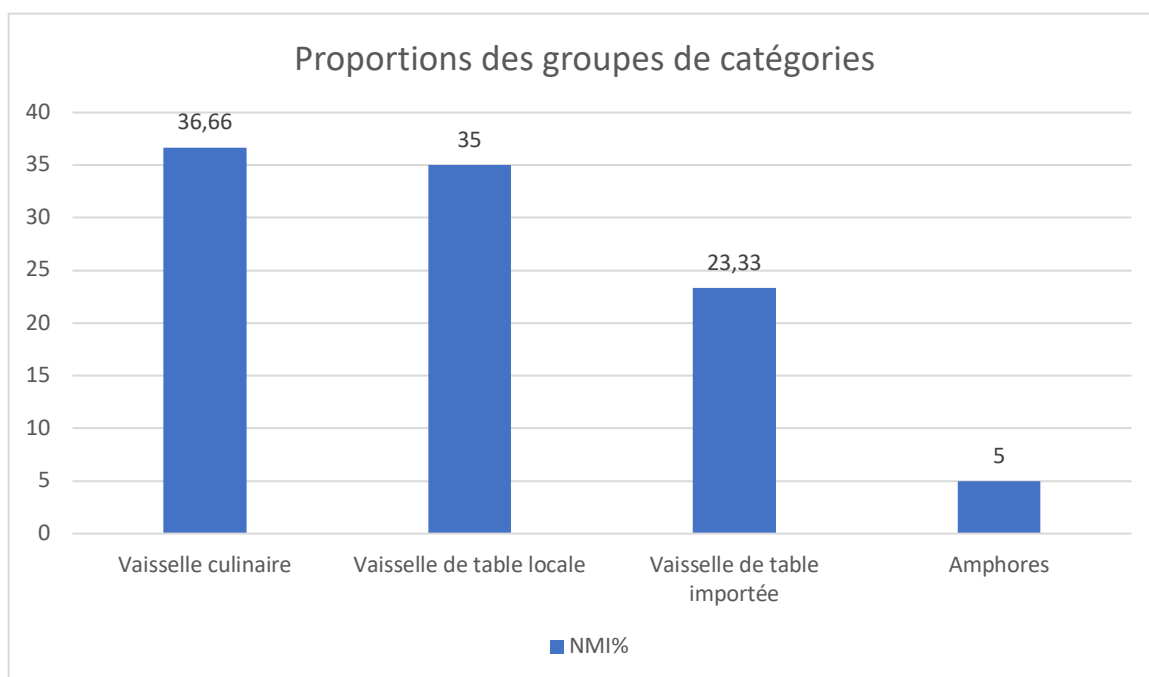


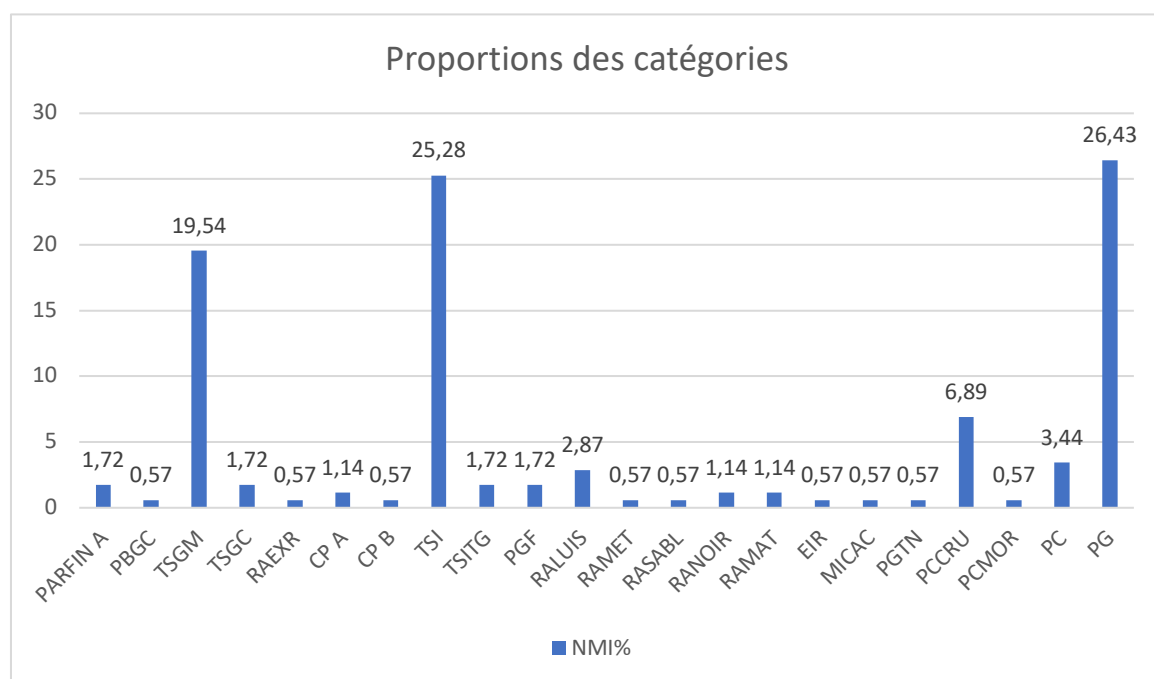
Fig. 30: Local 18: artisanat culinaire, puis lieu de stockage ?

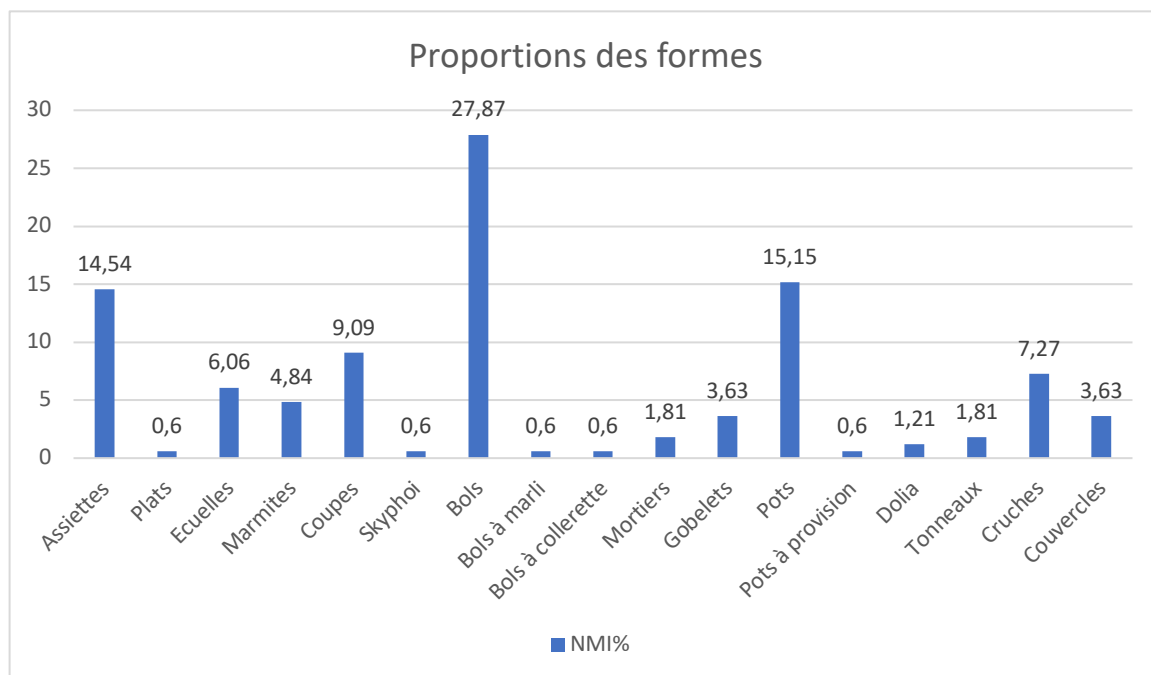
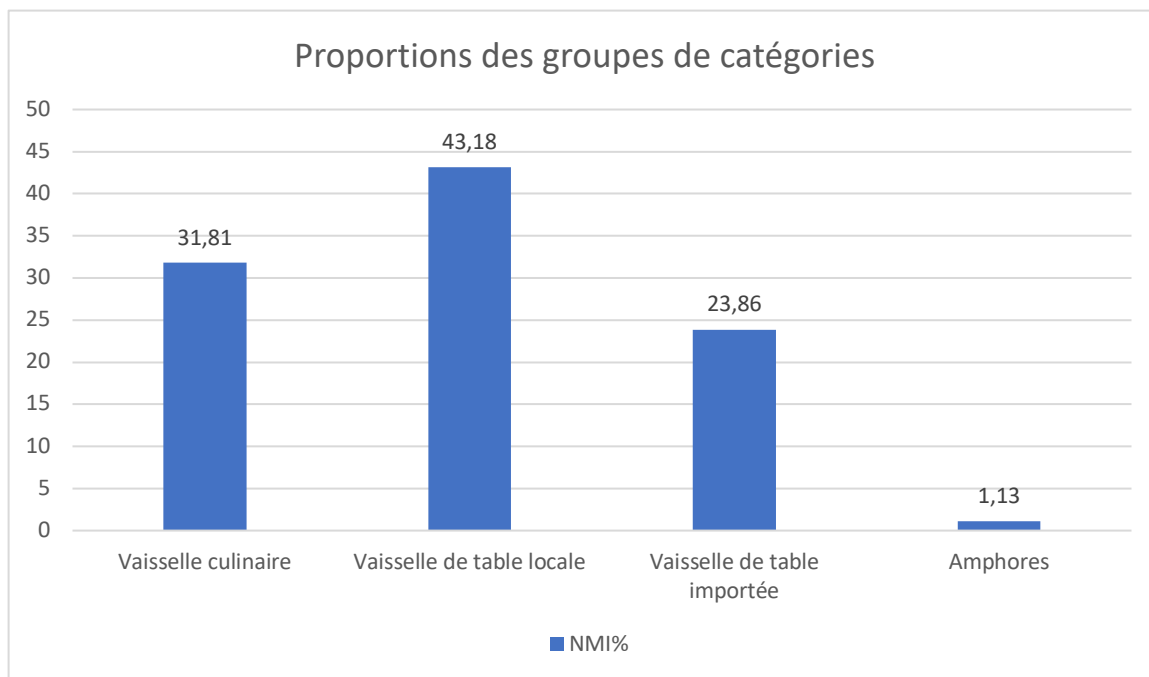
NMI	Catégories	%
3	PARFIN A	1,72
1	PBGC	0,57
34	TSGM	19,54
3	TSGC	1,72
1	RAEXR	0,57
2	CP A	1,14
1	CP B	0,57
44	TSI	25,28
3	TSITG	1,72
3	PGF	1,72
5	RALUIS	2,87
1	RAMET	0,57
1	RASABL	0,57
2	RANOIR	1,14
2	RAMAT	1,14
1	EIR	0,57
1	MICAC	0,57
1	PGTN	0,57
12	PCCRU	6,89
1	PCMOR	0,57
6	PC	3,44
46	PG	26,43
174		100%

NMI	Catégories	%
56	Vaisselle culinaire	31,81
76	Vaisselle de table locale	43,18
42	Vaisselle de table importée	23,86
2	Amphores	1,13
176		100%

NMI	Formes	%
24	Assiettes	14,54
1	Plats	0,6
10	Ecuelles	6,06
8	Marmites	4,84
15	Coupes	9,09
1	<i>Skyphoi</i>	0,6
46	Bols	27,87
1	Bols à marli	0,6
1	Bols à colerette	0,6
3	Mortiers	1,81
6	Gobelets	3,63
25	Pots	15,15
1	Pots à provision	0,6
2	<i>Dolia</i>	1,21
3	Tonneaux	1,81
12	Cruches	7,27
6	Couvercles	3,63
165		100%

NMI	Fonctions	%
9	Consommation liquide individuel	5,38
47	Consommation solide+ semi-liquide ind.	28,14
15	Service liquide commun/stockage	8,98
45	Service solide+semi-liquide commun	26,94
6	Préparation	3,59
16	Cuisson	9,58
21	Stockage	12,57
6	Fermeture	3,59
2	Transport	1,19
167		100%





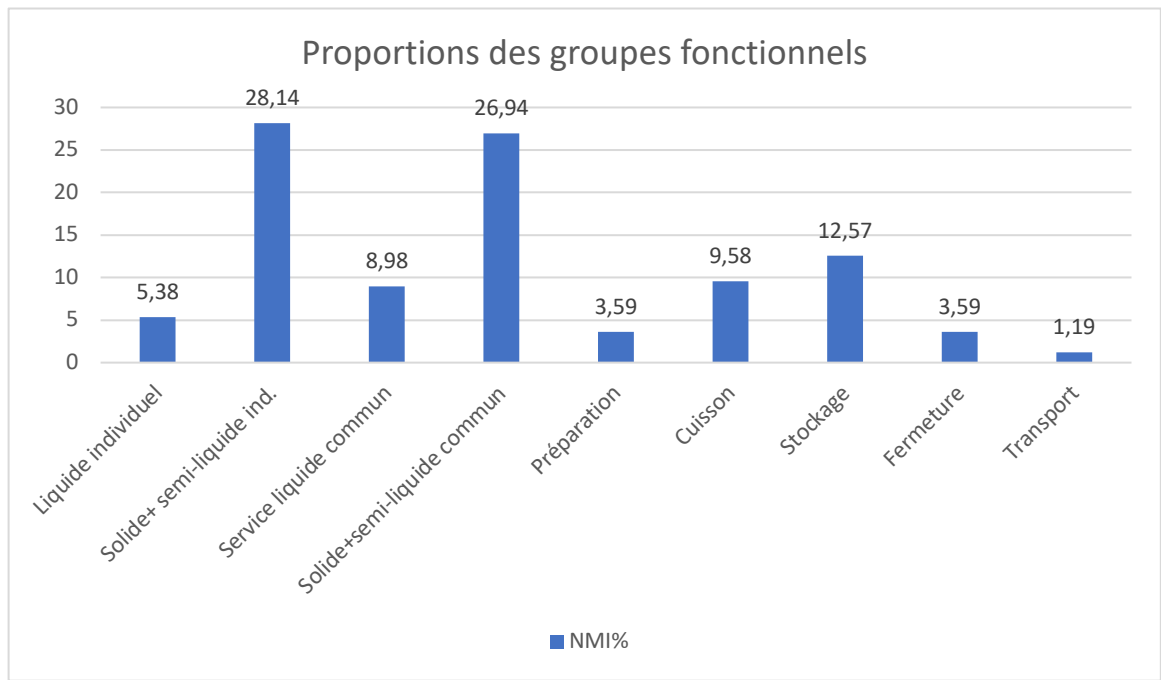


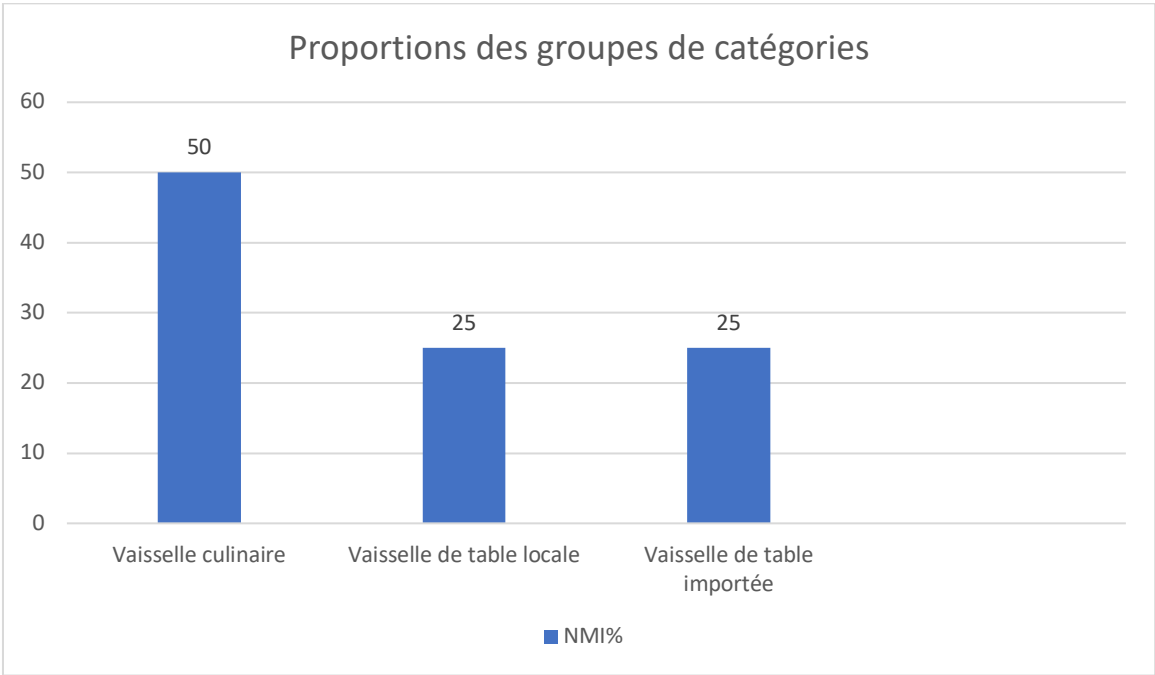
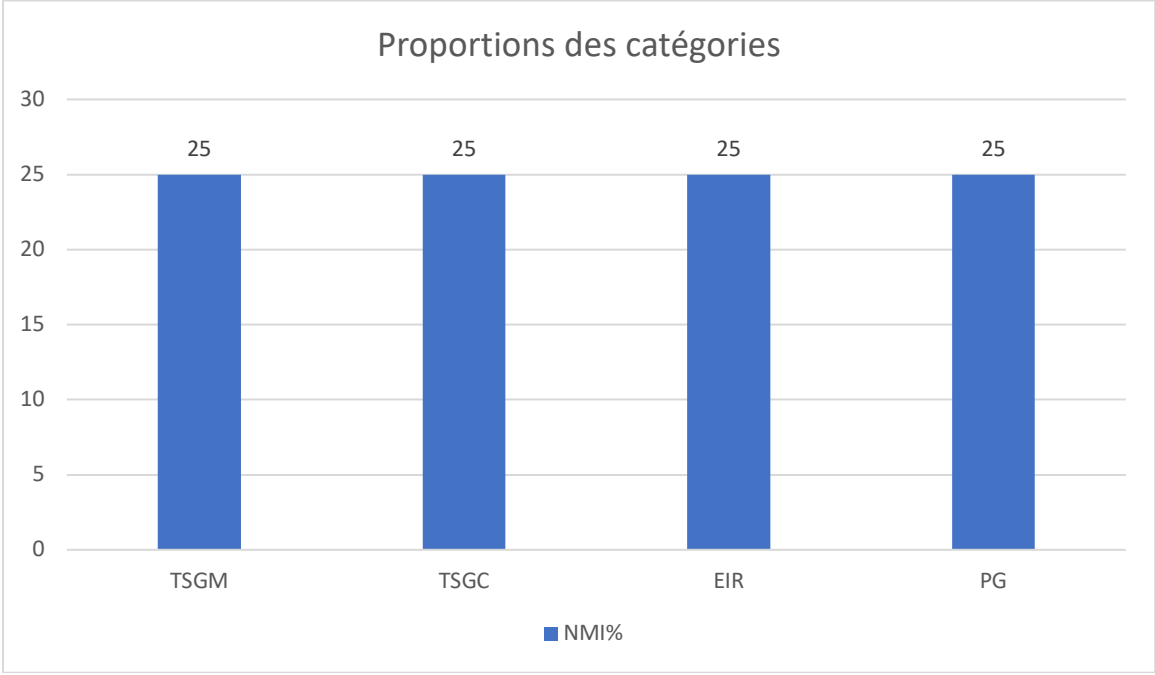
Fig. 31: Local 19: indéterminé.

NMI	Catégories	%
1	TSGM	25
1	TSGC	25
1	EIR	25
1	PG	25
4		100%

NMI	Catégories	%
2	Vaisselle culinaire	50
1	Vaisselle de table locale	25
1	Vaisselle de table importée	25
4		100%

NMI	Formes	%
1	Plats	33,33
1	Ecuellen	33,33
1	Coupes	33,33
3		100%

NMI	Fonctions	%
1	Consommation liquide individuel	33,33
1	Consommation solide+ semi-liquide ind.	33,33
0	Service liquide commun/stockage	0
0	Service solide+semi-liquide commun	0
0	Préparation	0
1	Cuisson	33,33
0	Stockage	0
0	Fermeture	0
0	Transport	0
3		100%



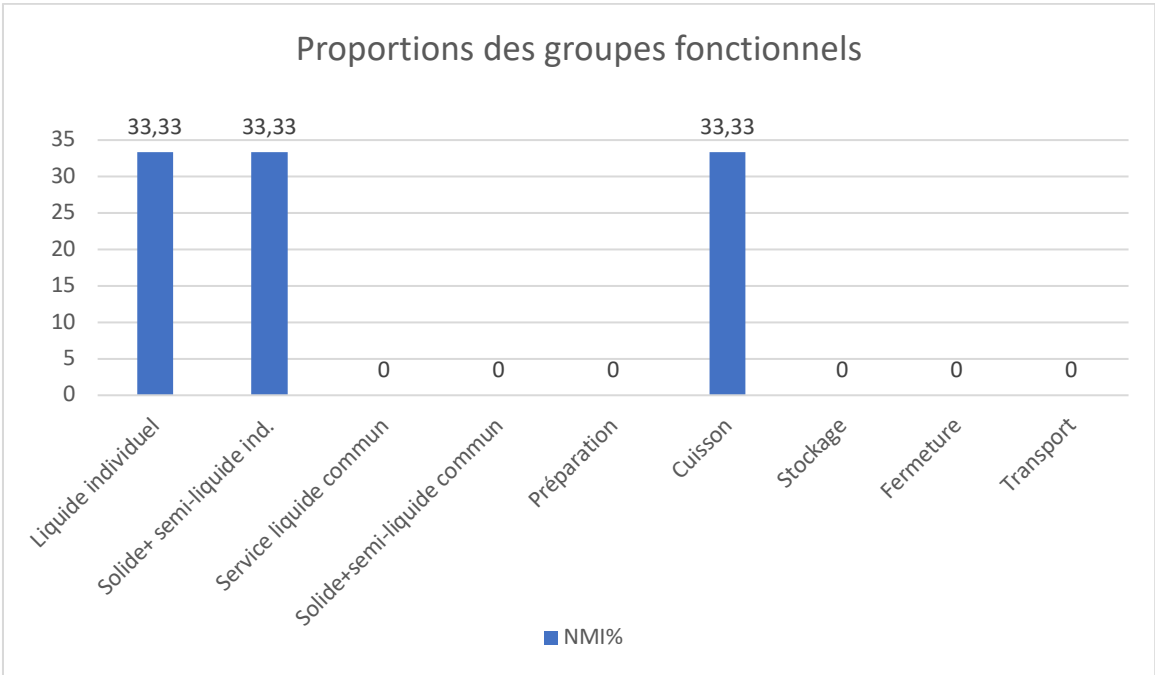
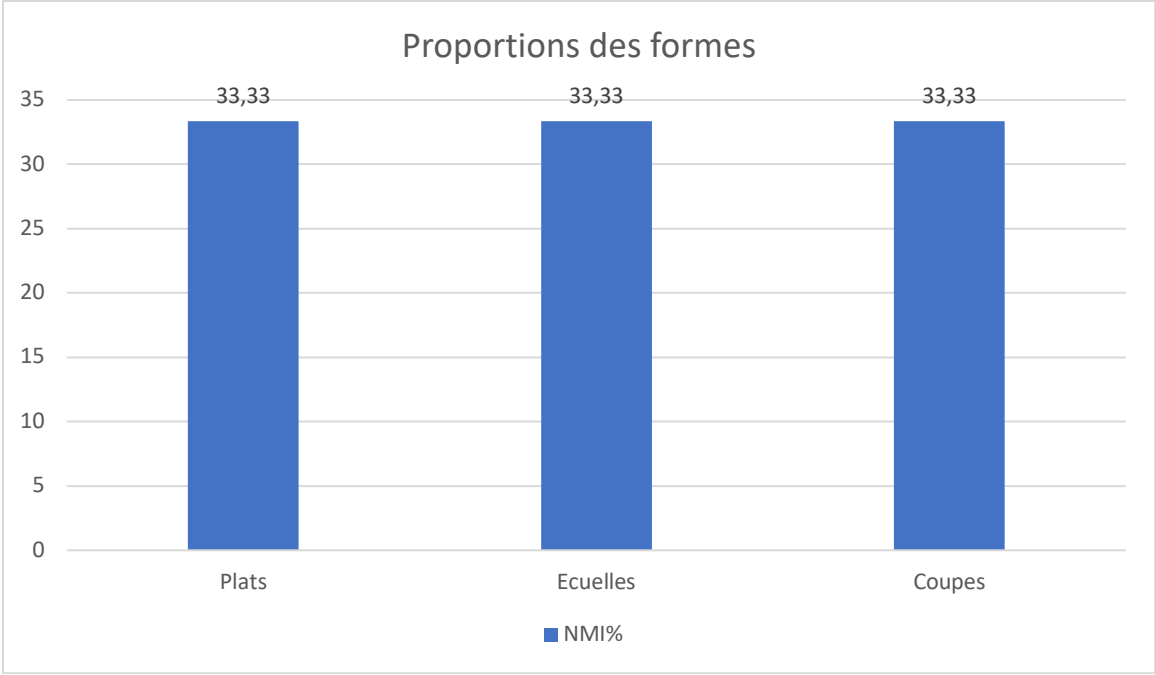


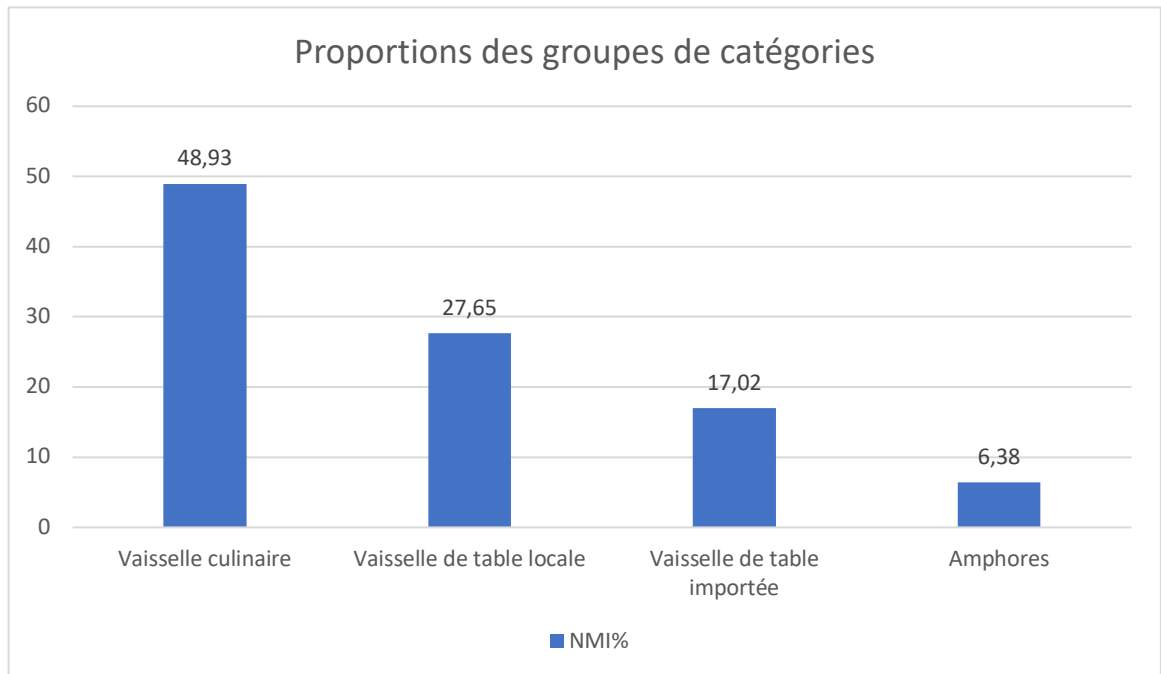
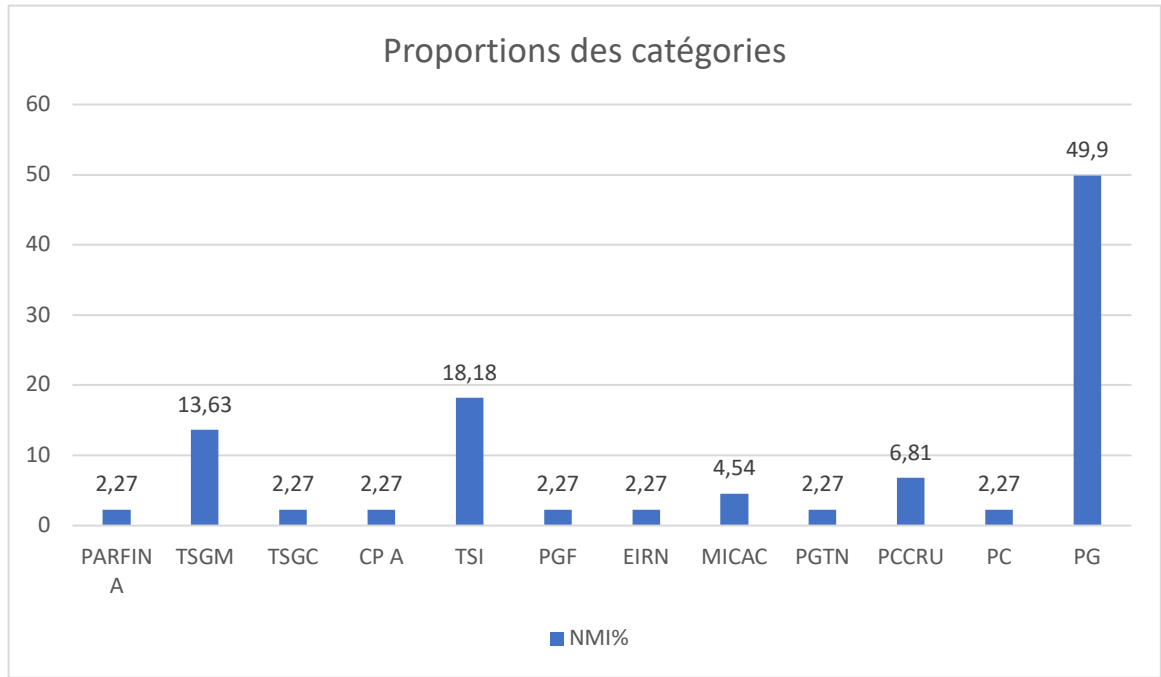
Fig. 32: Local 21: échoppe, commerce alimentaire.

NMI	Catégories	%
1	PARFIN A	2,27
6	TSGM	13,63
1	TSGC	2,27
1	CP A	2,27
8	TSI	18,18
1	PGF	2,27
1	EIRN	2,27
2	MICAC	4,54
1	PGTN	2,27
3	PCCRU	6,81
1	PC	2,27
18	PG	49,9
44		100%

NMI	Catégories	%
23	Vaisselle culinaire	48,93
13	Vaisselle de table locale	27,65
8	Vaisselle de table importée	17,02
3	Amphores	6,38
47		100%

NMI	Formes	%
7	Assiettes	18,91
1	Plats	2,7
1	Ecuelles	2,7
3	Coupes	8,1
4	Bols	10,81
2	Bols à collerette	5,4
1	Marmites	2,7
2	Gobelets	5,4
9	Pots	24,32
1	<i>Dolia</i>	2,7
4	Cruches	10,81
1	Pichets	2,7
1	Couvercle	2,7
37		100%

NMI	Fonctions	%
2	Consommation liquide individuel	4,54
4	Consommation solide+ semi-liquide ind.	9,09
5	Service liquide commun/stockage	11,36
11	Service solide+semi-liquide commun	25
1	Préparation	2,27
9	Cuisson	20,45
8	Stockage	18,18
1	Fermeture	2,27
3	Transport	6,81
44		100%



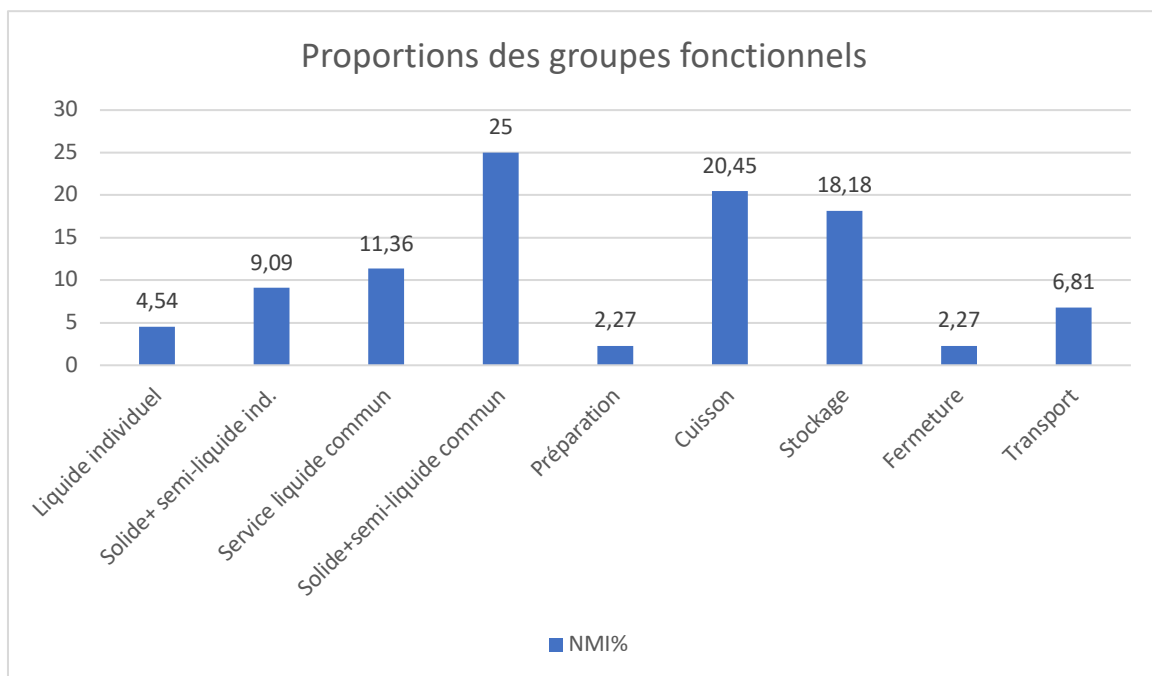
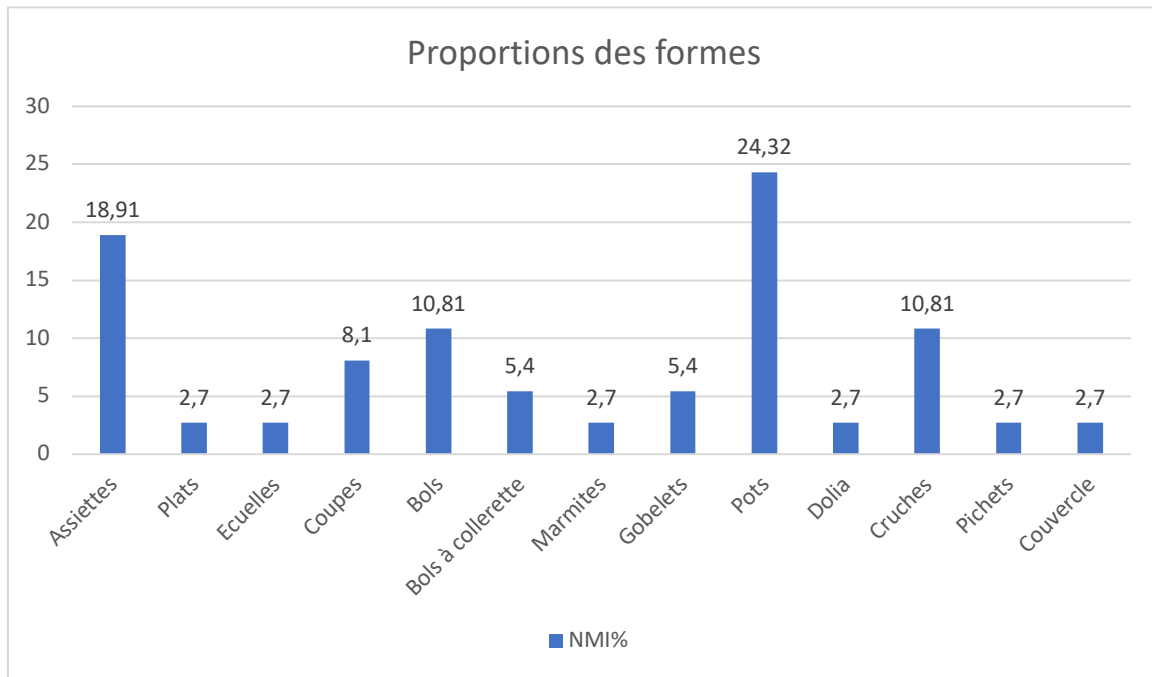


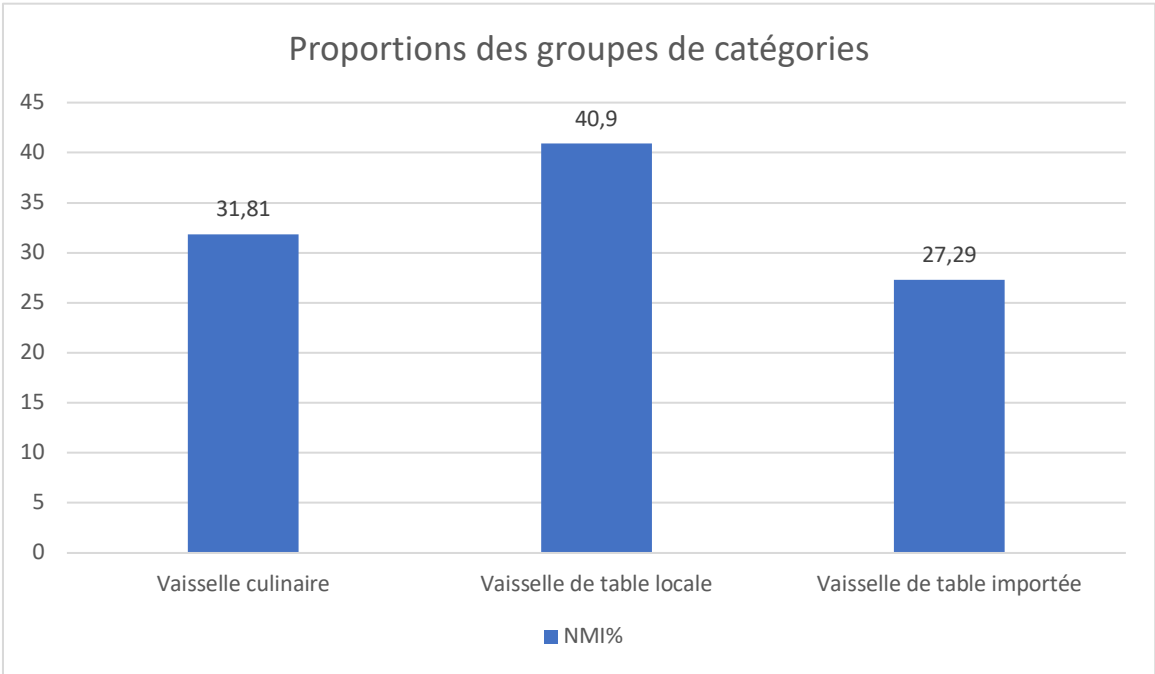
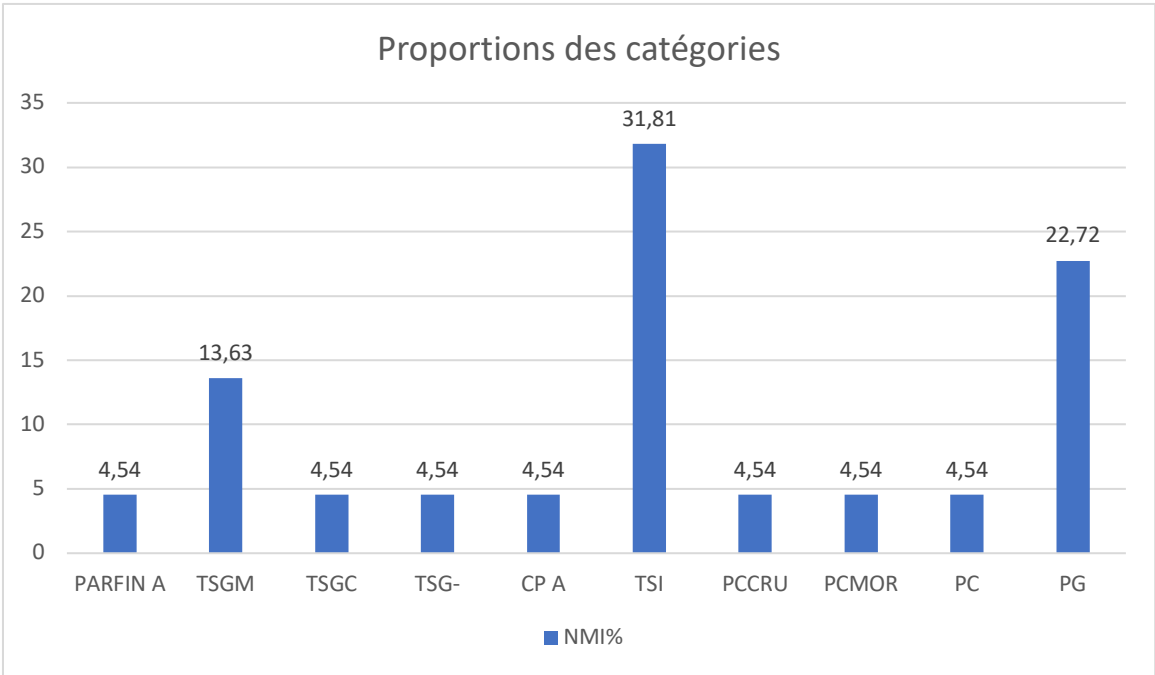
Fig. 33: Local 24: pièce de séjour ?

NMI	Catégories	%
1	PARFIN A	4,54
3	TSGM	13,63
1	TSGC	4,54
1	TSG-	4,54
1	CP A	4,54
7	TSI	31,81
1	PCCRU	4,54
1	PCMOR	4,54
1	PC	4,54
5	PG	22,72
22		100%

NMI	Catégories	%
7	Vaisselle culinaire	31,81
9	Vaisselle de table locale	40,9
6	Vaisselle de table importée	27,29
22		100%

NMI	Formes	%
4	Assiettes	20
1	Ecuelles	5
1	Marmites	5
3	Coupes	15
4	Bols	20
1	Bols à collerette	5
1	Mortiers	5
3	Pots	15
1	Cruches	5
1	Couvercles	5
20		100%

NMI	Fonctions	%
0	Consommation liquide individuel	0
5	Consommation solide+ semi-liquide ind.	25
1	Service liquide commun/stockage	5
8	Service solide+semi-liquide commun	40
1	Préparation	5
1	Cuisson	5
3	Stockage	15
1	Fermeture	5
0	Transport	0
20		100%



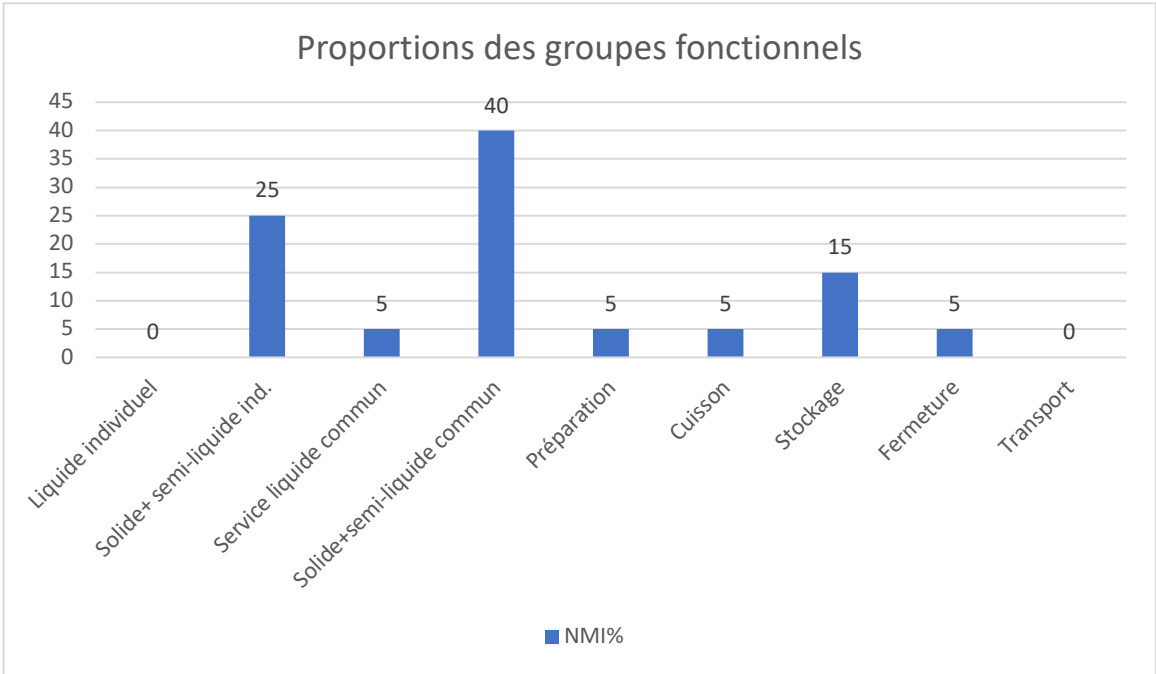
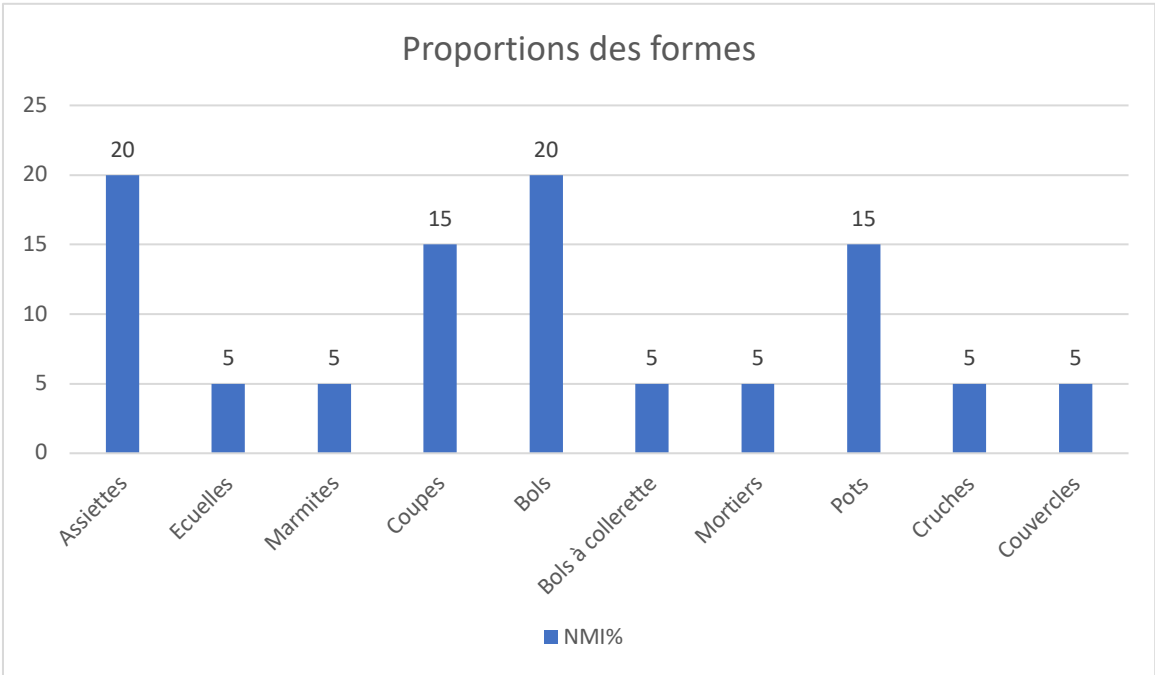


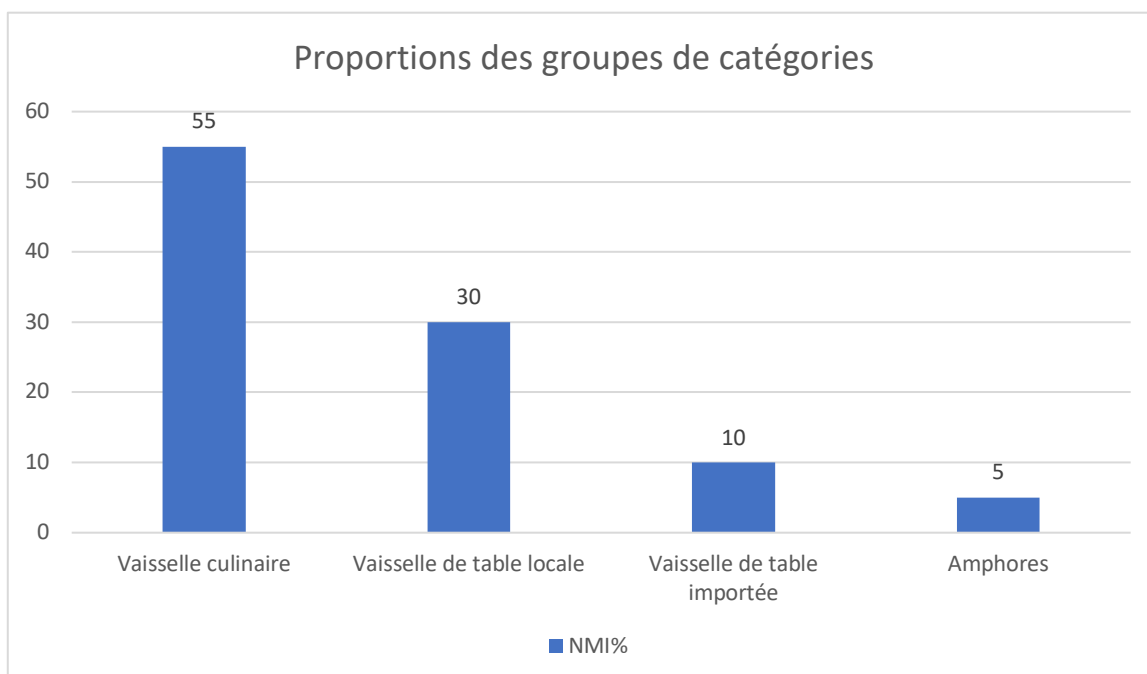
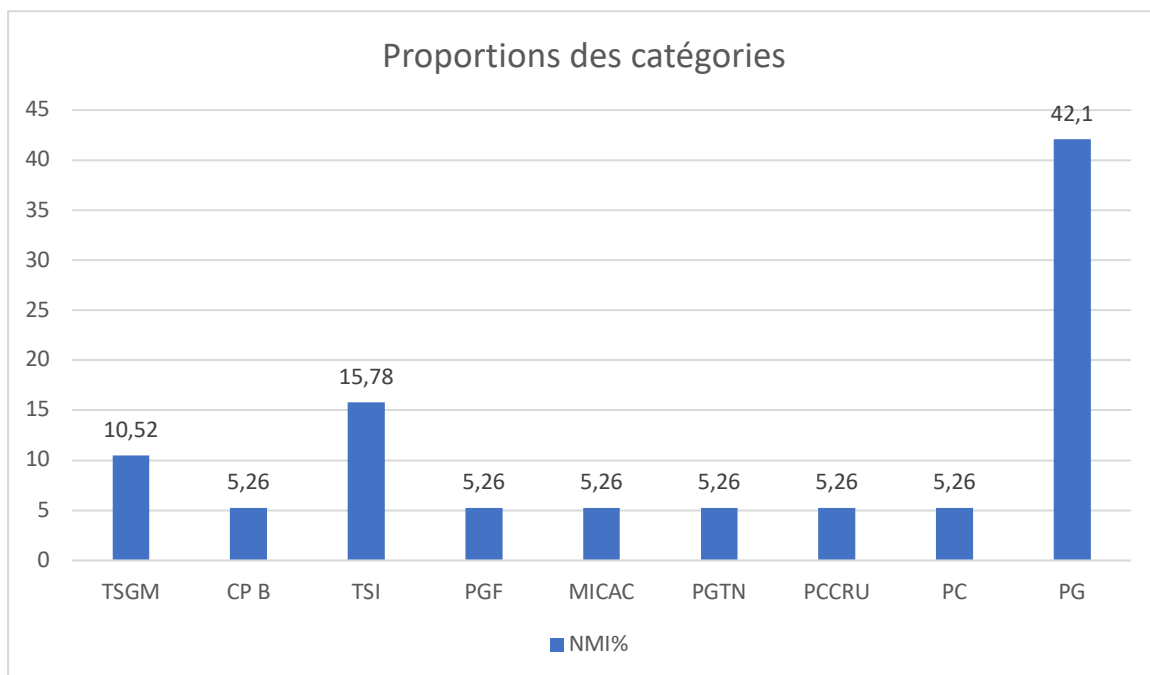
Fig. 34: Local 25: couloir ou ruelle ?

NMI	Catégories	%
2	TSGM	10,52
1	CP B	5,26
3	TSI	15,78
1	PGF	5,26
1	MICAC	5,26
1	PGTN	5,26
1	PCCRU	5,26
1	PC	5,26
8	PG	42,1
19		100%

NMI	Catégories	%
11	Vaisselle culinaire	55
6	Vaisselle de table locale	30
2	Vaisselle de table importée	10
1	Amphores	5
20		100%

NMI	Formes	%
1	Marmites	5,88
3	Coupes	17,64
1	Bols	5,88
7	Pots	41,17
1	Cruches	5,88
13		100%

NMI	Fonctions	%
0	Consommation liquide individuel	0
5	Consommation solide+ semi-liquide ind.	31,25
1	Service liquide commun/stockage	6,25
3	Service solide+semi-liquide commun	18,75
0	Préparation	0
3	Cuisson	18,75
4	Stockage	25
0	Fermeture	0
0	Transport	0
16		100%



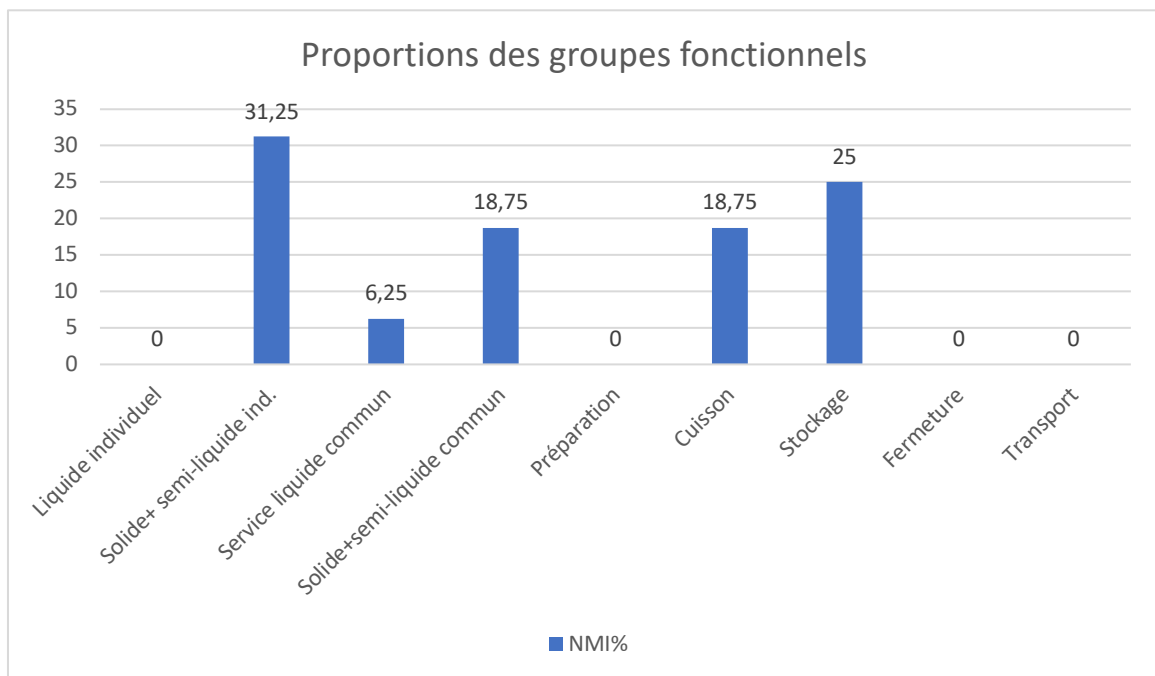
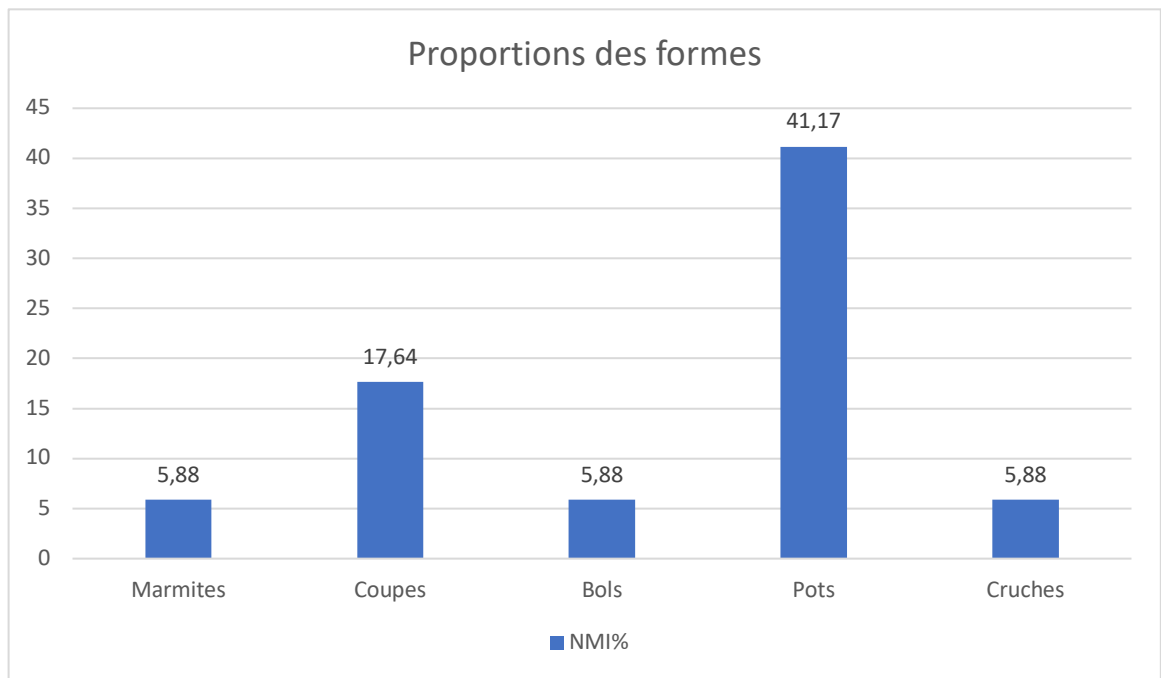
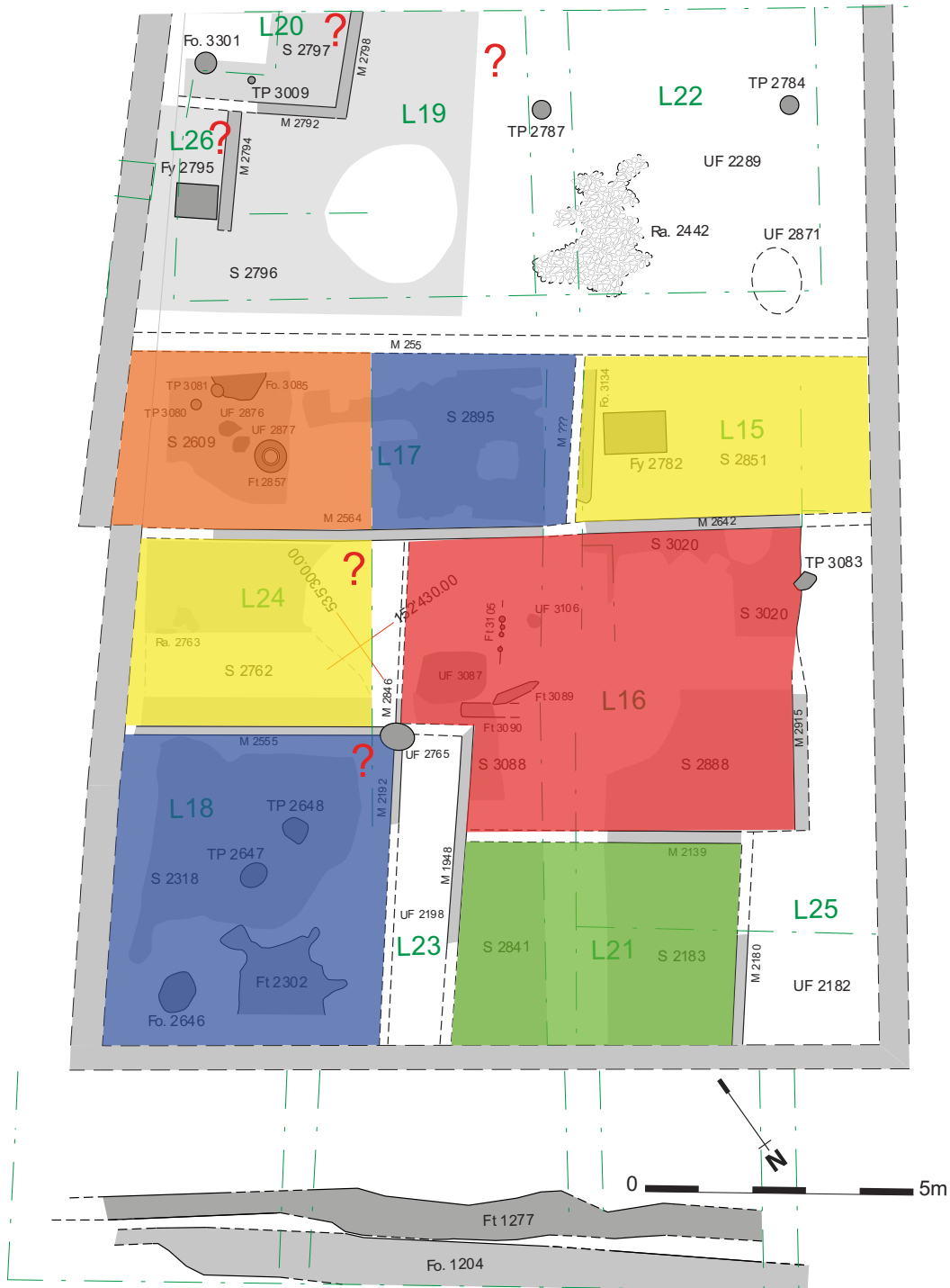
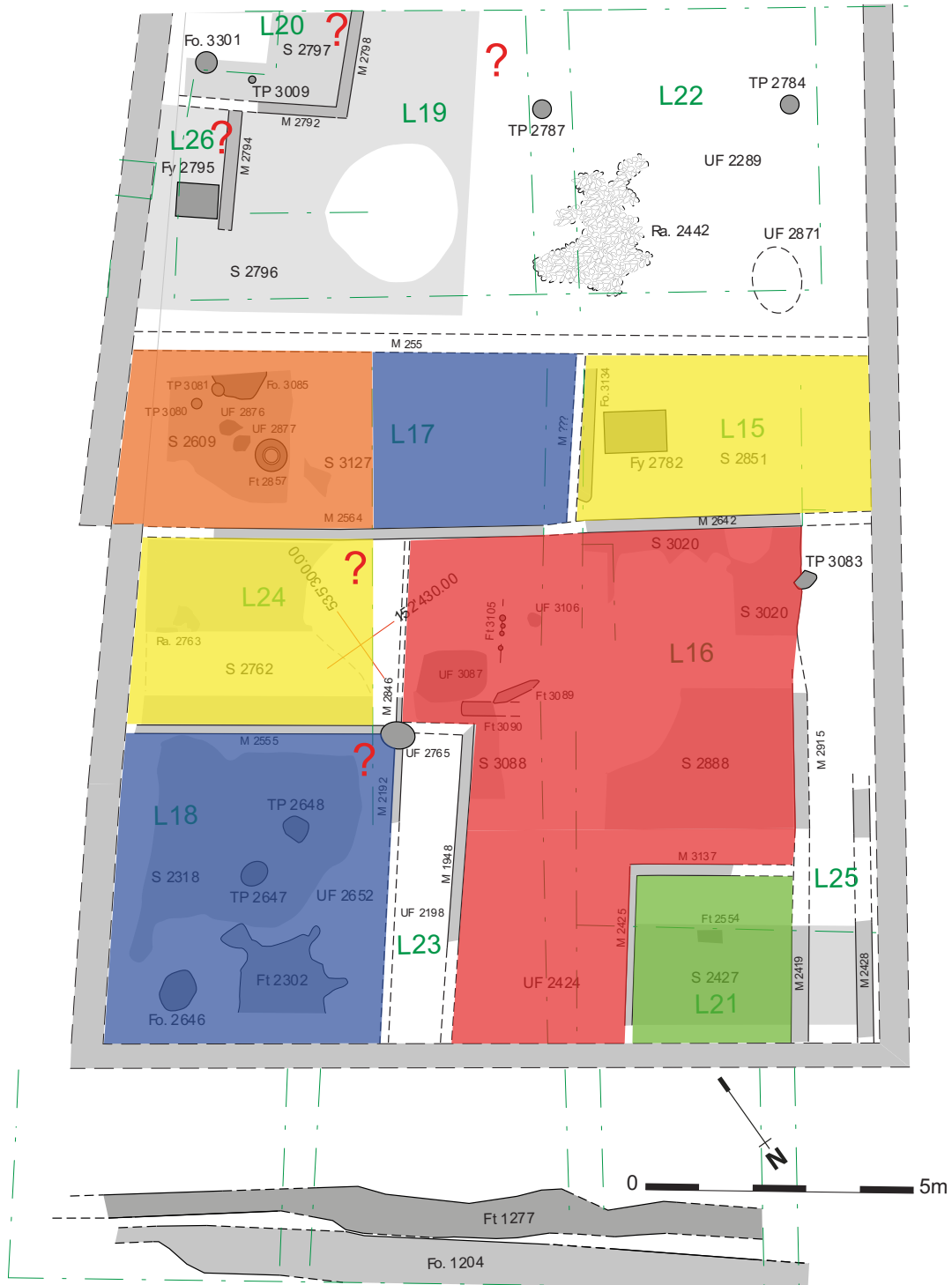


Fig. 35.1: Proposition d'attribution fonctionnelle des locaux de la période D-1a.



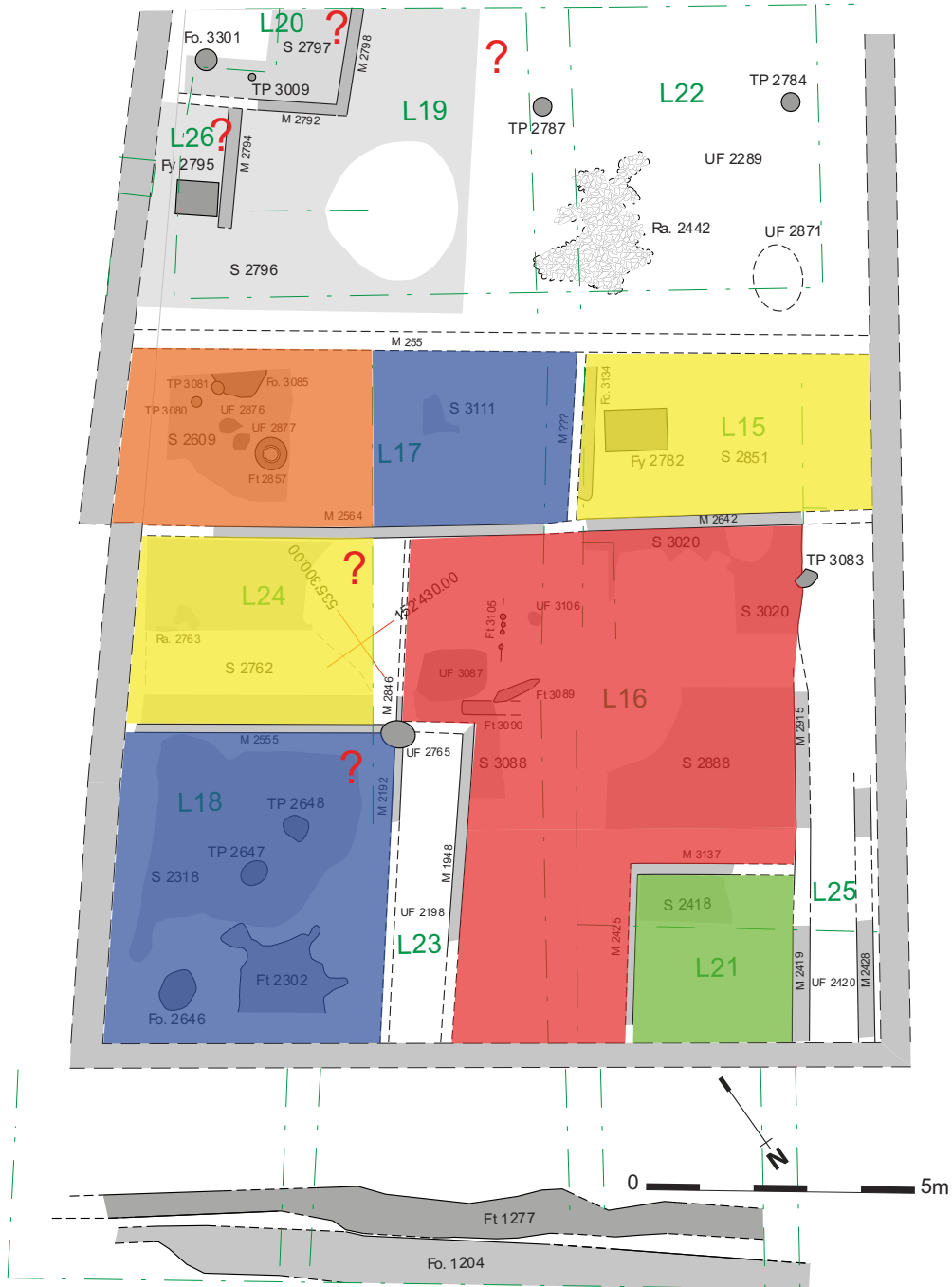
- | | |
|--|---|
| Séjour (domestique) | Stockage |
| Cuisine (domestique) | Echoppe (commerce alimentaire ?) |
| Atelier artisanal (boucherie ? artisanat culinaire ?) | Cours, couloirs |

Fig.35.2: Proposition d'attribution fonctionnelle des locaux de la période D-1b.



- | | |
|---|--|
| Séjour (domestique) | Stockage |
| Cuisine (domestique) | Echoppe (commerce alimentaire ?) |
| Atelier artisanal (boucherie ? artisanat culinaire ?) | Cours, couloirs |

Fig.35.3: Proposition d'attribution fonctionnelle des locaux de la période D-1c.



- | | |
|--|---|
| Séjour (domestique) | Stockage |
| Cuisine (domestique) | Echoppe (commerce alimentaire ?) |
| Atelier artisanal (boucherie ? artisanat culinaire ?) | Cours, couloirs |

Fig.35.4: Proposition d'attribution fonctionnelle des locaux de la période D-1d.



- | | |
|---|--|
| Séjour (domestique) | Stockage |
| Cuisine (domestique) | Echoppe (commerce alimentaire ?) |
| Atelier artisanal (boucherie ? artisanat culinaire ?) | Cours, couloirs |

4.2.2. Période D-2 (150/180 ap. J.-C.)

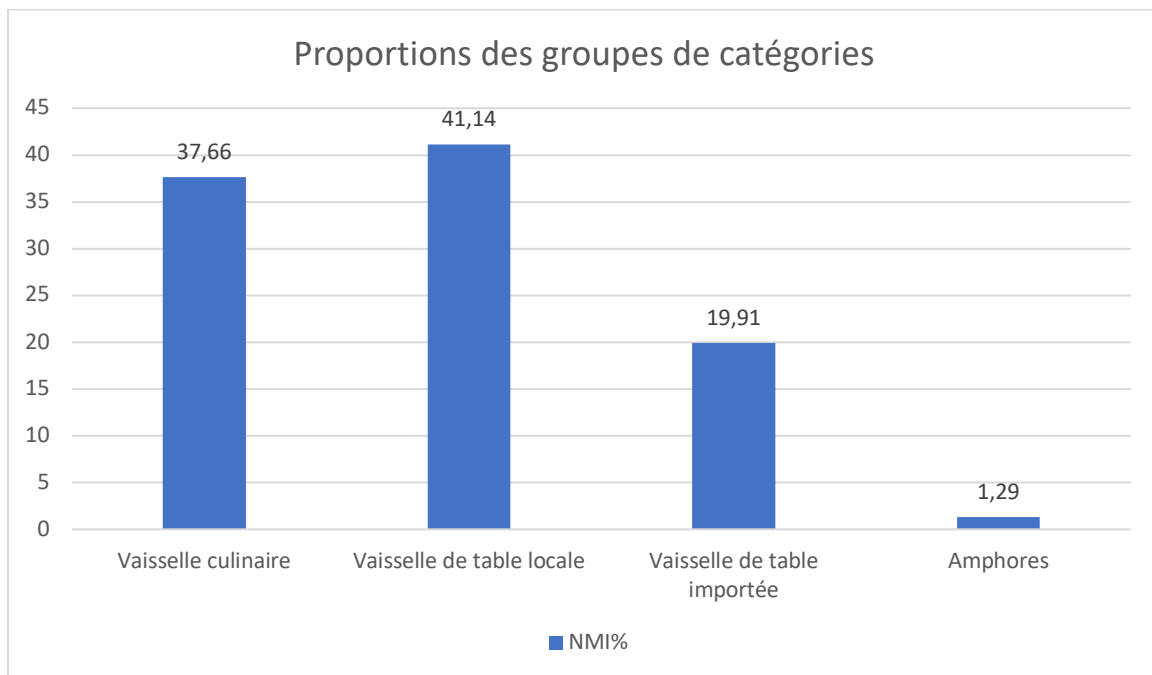
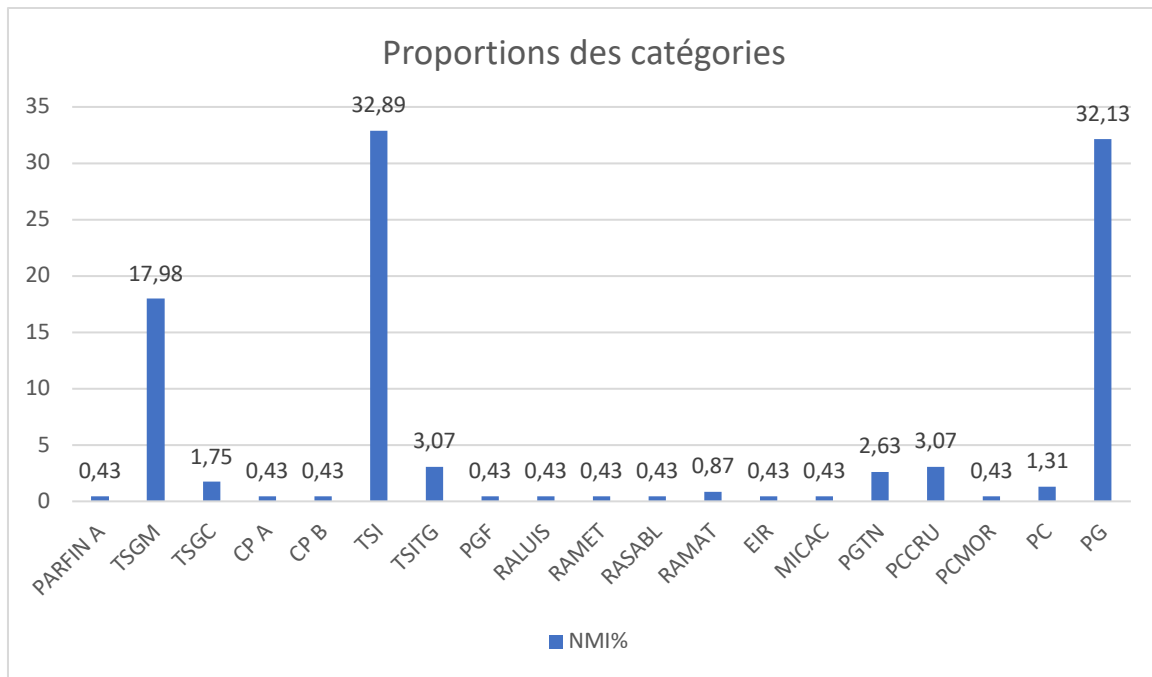
Fig.36:Local 16: atelier artisanal (boucherie, artisanat culinaire ?).

NMI	Catégories	%
1	PARFIN A	0,43
41	TSGM	17,98
4	TSGC	1,75
1	CP A	0,43
1	CP B	0,43
75	TSI	32,89
7	TSITG	3,07
1	PGF	0,43
1	RALUIS	0,43
1	RAMET	0,43
1	RASABL	0,43
2	RAMAT	0,87
1	EIR	0,43
1	MICAC	0,43
6	PGTN	2,63
7	PCCRU	3,07
1	PCMOR	0,43
3	PC	1,31
73	PG	32,13
228		100%

NMI	Catégories	%
87	Vaisselle culinaire	37,66
95	Vaisselle de table locale	41,14
46	Vaisselle de table importée	19,91
3	Amphores	1,29
231		100%

NMI	Formes	%
48	Assiettes	21,23
1	Plats	0,44
11	Ecuellen	4,86
5	Marmites	2,21
33	Coupes	14,6
1	Calices	0,44
49	Bols	21,68
4	Bols à collerette	1,76
1	Mortiers	0,44
3	Gobelets	1,32
39	Pots	17,25
5	Tonneaux	2,21
7	Cruches	3,09
1	Pichets	0,44
17	Couvercles	7,52
1	Jetons	0,44
226		100%

NMI	Fonctions	%
6	Consommation liquide individuel	2,62
55	Consommation solide+ semi-liquide ind.	24,01
13	Service liquide commun/stockage	5,67
84	Service solide+semi-liquide commun	36,68
5	Préparation	2,18
16	Cuisson	6,98
29	Stockage	12,69
18	Fermeture	7,86
3	Transport	1,31
229		100%



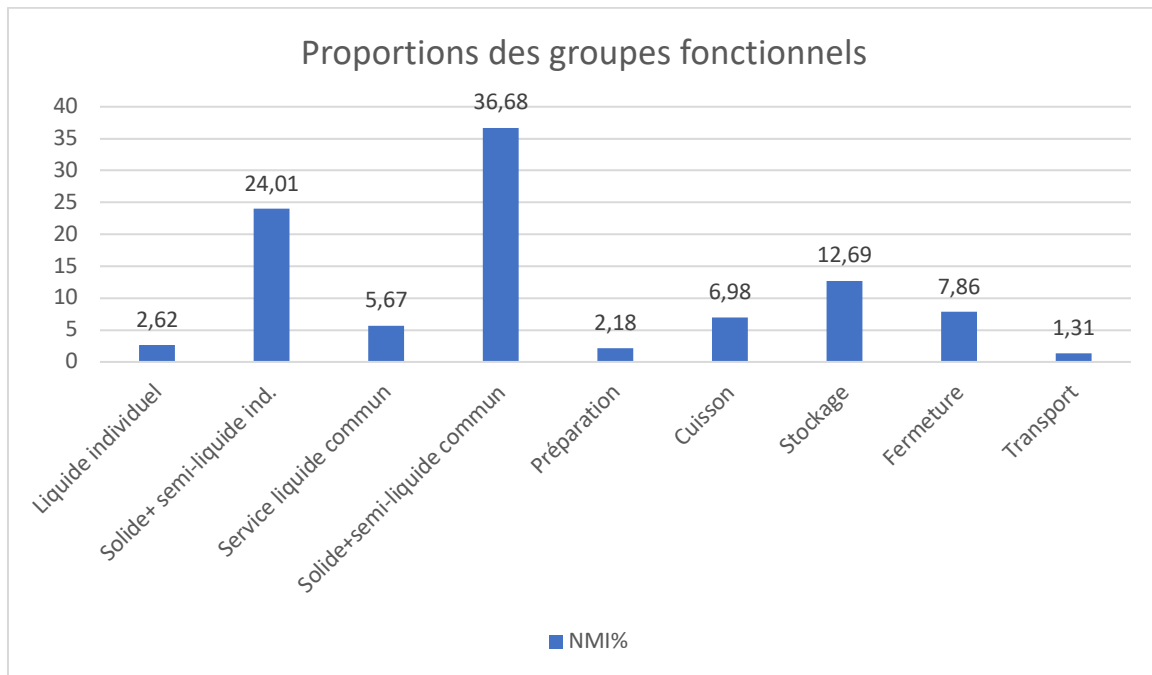
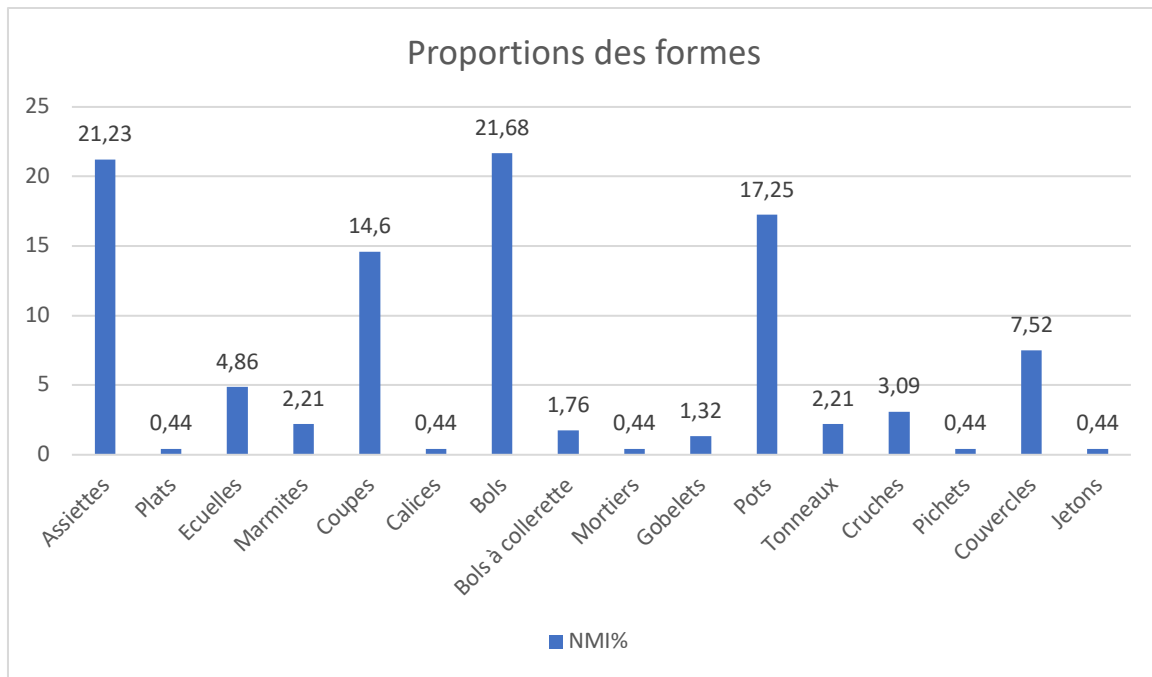


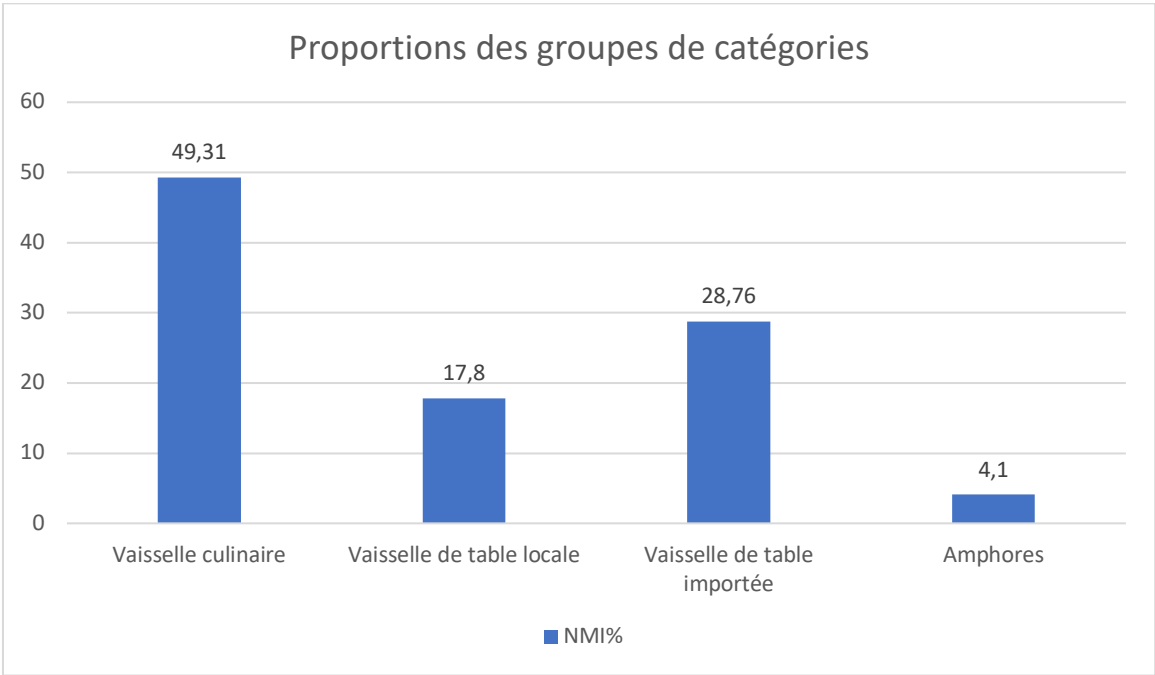
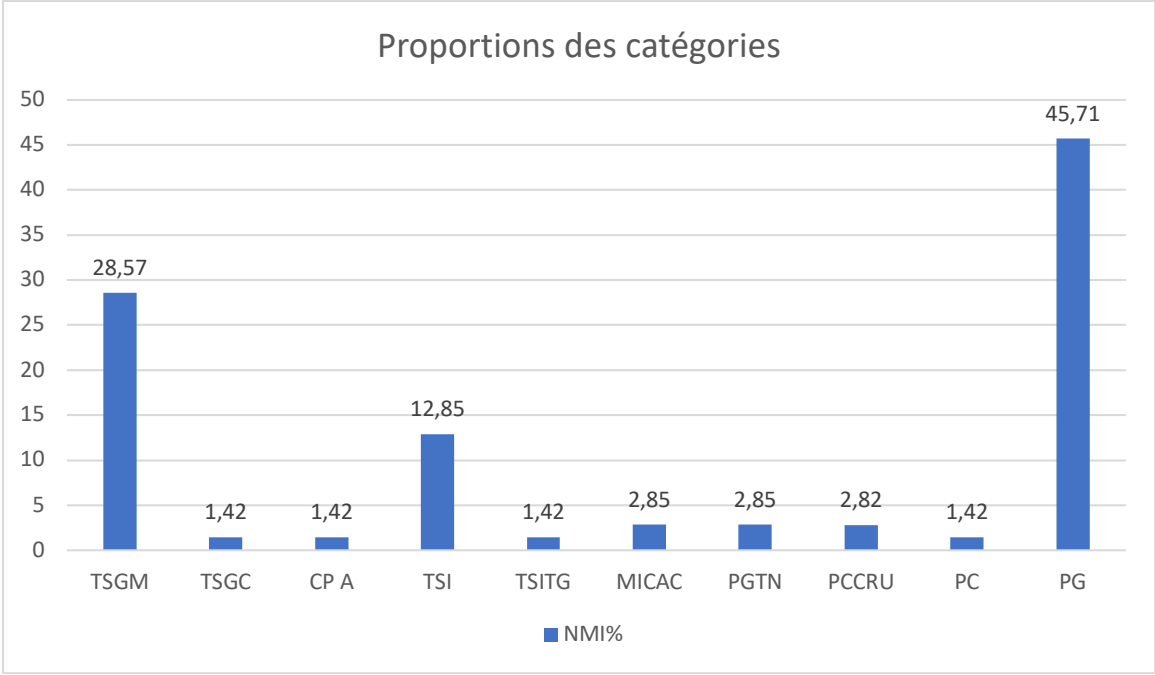
Fig.37.1:Local 17a: indéterminé.

NMI	Catégories	%
20	TSGM	28,57
1	TSGC	1,42
1	CP A	1,42
9	TSI	12,85
1	TSITG	1,42
1	MICAC	2,85
2	PGTN	2,85
2	PCCRU	2,82
1	PC	1,42
32	PG	45,71
70		100%

NMI	Catégories	%
36	Vaisselle culinaire	49,31
13	Vaisselle de table locale	17,8
21	Vaisselle de table importée	28,76
3	Amphores	4,1
73		100%

NMI	Formes	%
7	Assiettes	10,44
13	Ecuelles	19,4
5	Marmites	7,46
9	Coupes	13,43
1	Pixides	1,49
14	Bols	20,89
1	Bols à collerette	1,49
1	Gobelets	1,49
6	Pots	8,95
2	<i>Dolia</i>	2,98
2	Tonneaux	2,98
2	Cruches	2,98
4	Couvercles	5,97
67		100%

NMI	Fonctions	%
3	Consommation liquide individuel	4,28
20	Consommation solide+ semi-liquide ind.	28,57
4	Service liquide commun/stockage	5,71
20	Service solide+semi-liquide commun	28,57
2	Préparation	2,85
10	Cuisson	14,28
3	Stockage	4,28
4	Fermeture	5,71
3	Transport	4,28
1	Parure	1,42
70		100%



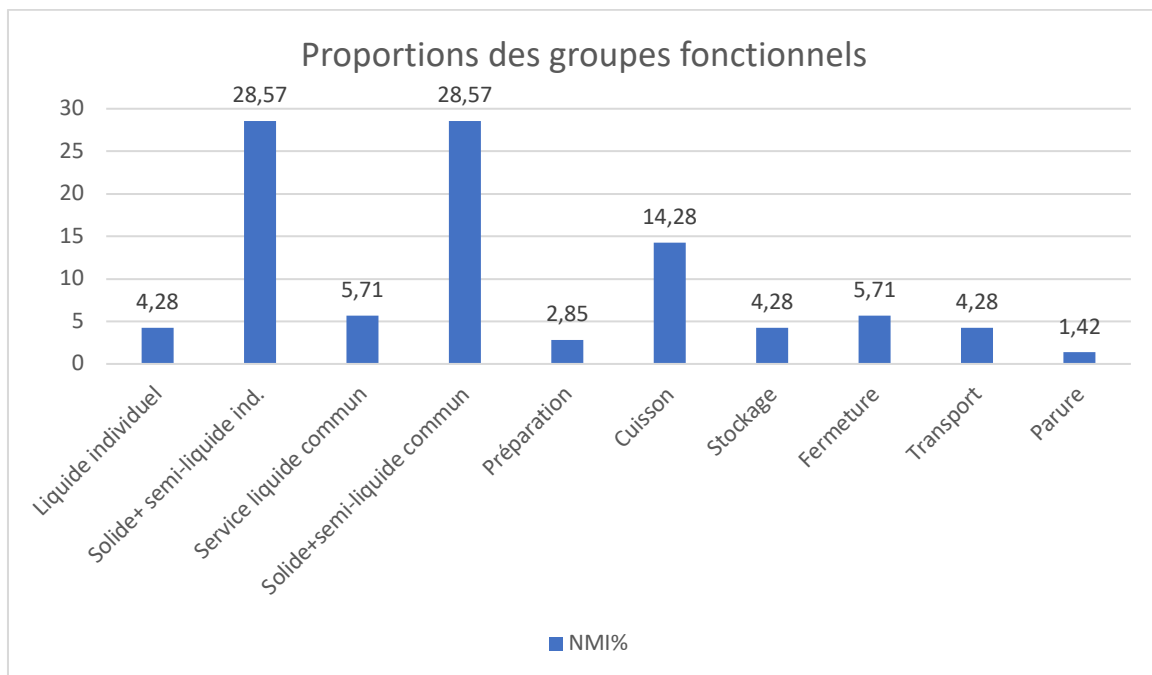
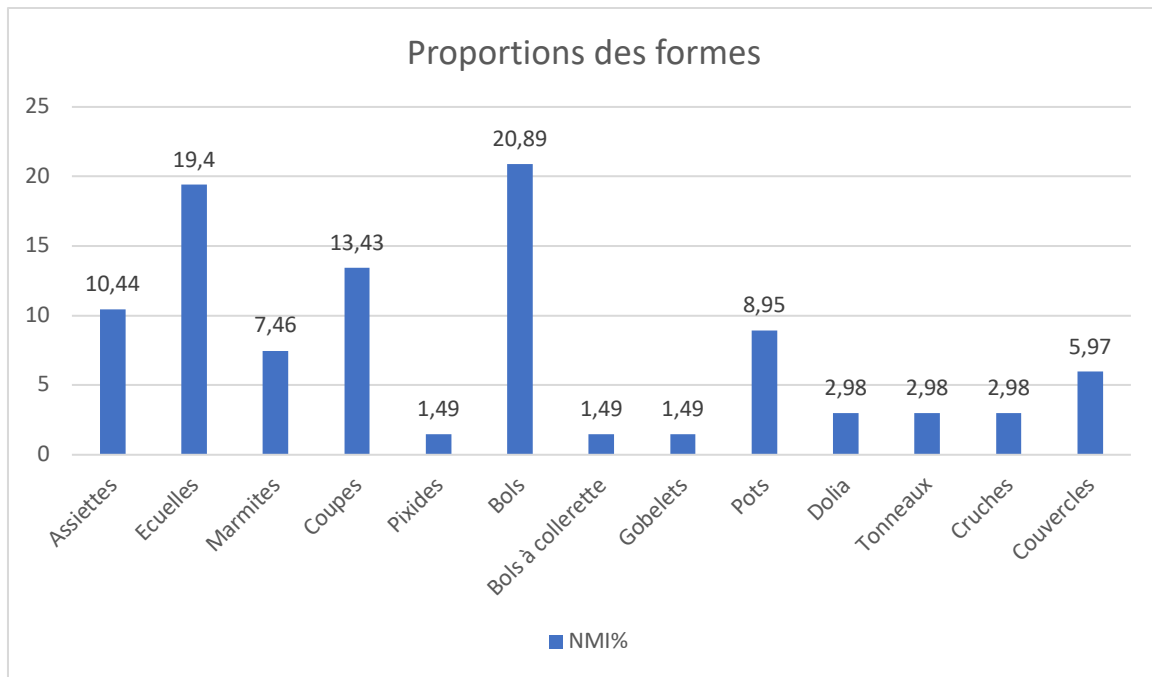


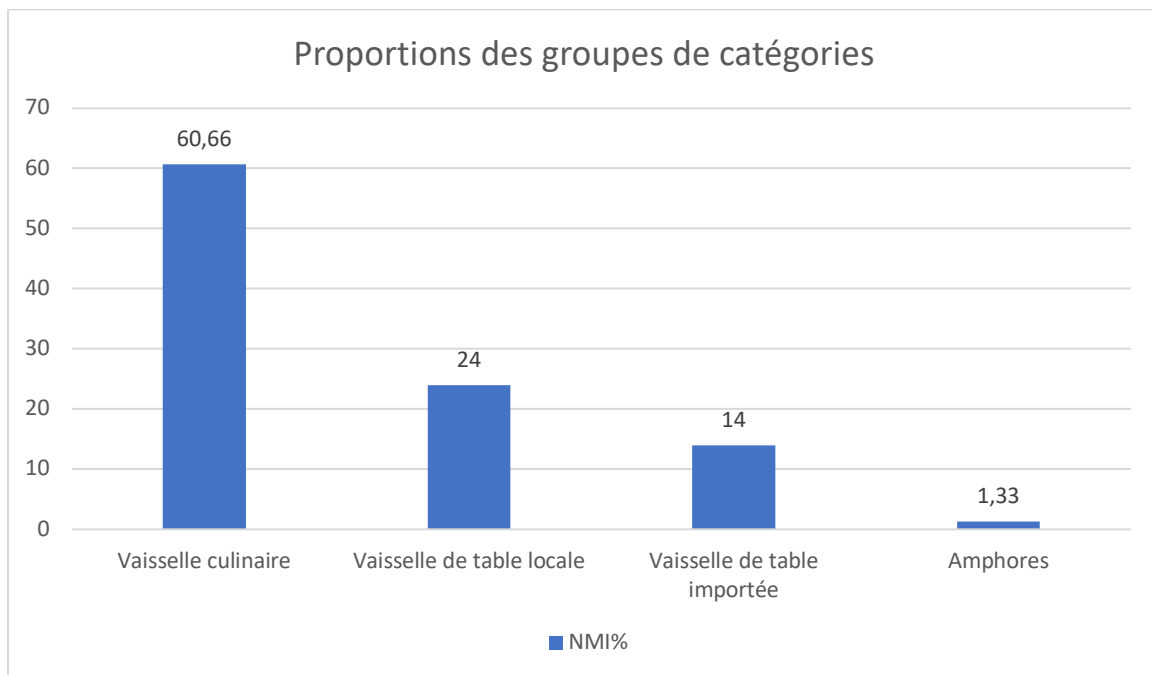
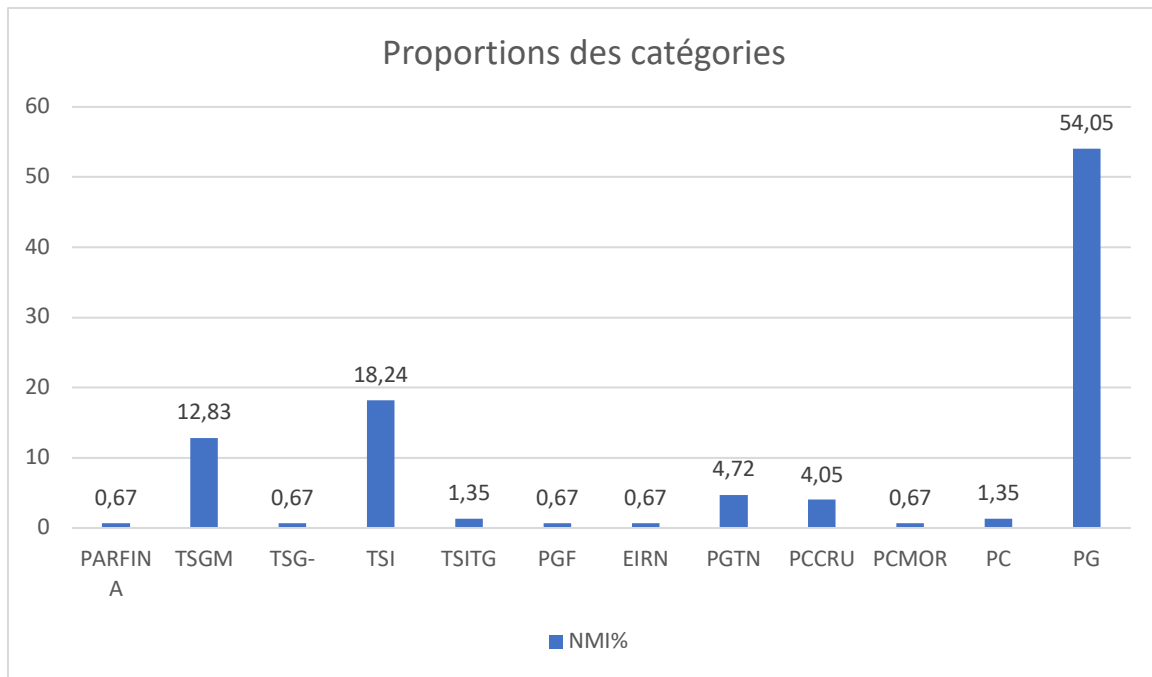
Fig.37.2: Local 17b: cuisine/stockage.

NMI	Catégories	%
1	PARFIN A	0,67
19	TSGM	12,83
1	TSG-	0,67
27	TSI	18,24
2	TSITG	1,35
1	PGF	0,67
1	EIRN	0,67
7	PGTN	4,72
6	PCCRU	4,05
1	PCMOR	0,67
2	PC	1,35
80	PG	54,05
148		100%

NMI	Catégories	%
91	Vaisselle culinaire	60,66
36	Vaisselle de table locale	24
21	Vaisselle de table importée	14
2	Amphores	1,33
150		100%

NMI	Formes	%
11	Assiettes	7,38
2	Plats	1,34
25	Ecuellen	16,77
12	Marmites	8,05
16	Coupes	10,73
20	Bols	13,42
1	Bols à collerette	0,67
1	Mortiers	0,67
3	Gobelets	2,01
31	Pots	20,8
3	<i>Dolia</i>	2,01
1	Tonneaux	0,67
6	Cruches	4,02
17	Couvercles	11,4
149		100%

NMI	Fonctions	%
5	Consommation liquide individuel	3,9
20	Consommation solide+ semi-liquide ind.	15,62
7	Service liquide commun/stockage	5,46
28	Service solide+semi-liquide commun	21,87
19	Préparation	14,84
12	Cuisson	9,37
18	Stockage	14,06
17	Fermeture	13,28
2	Transport	1,56
128		100%



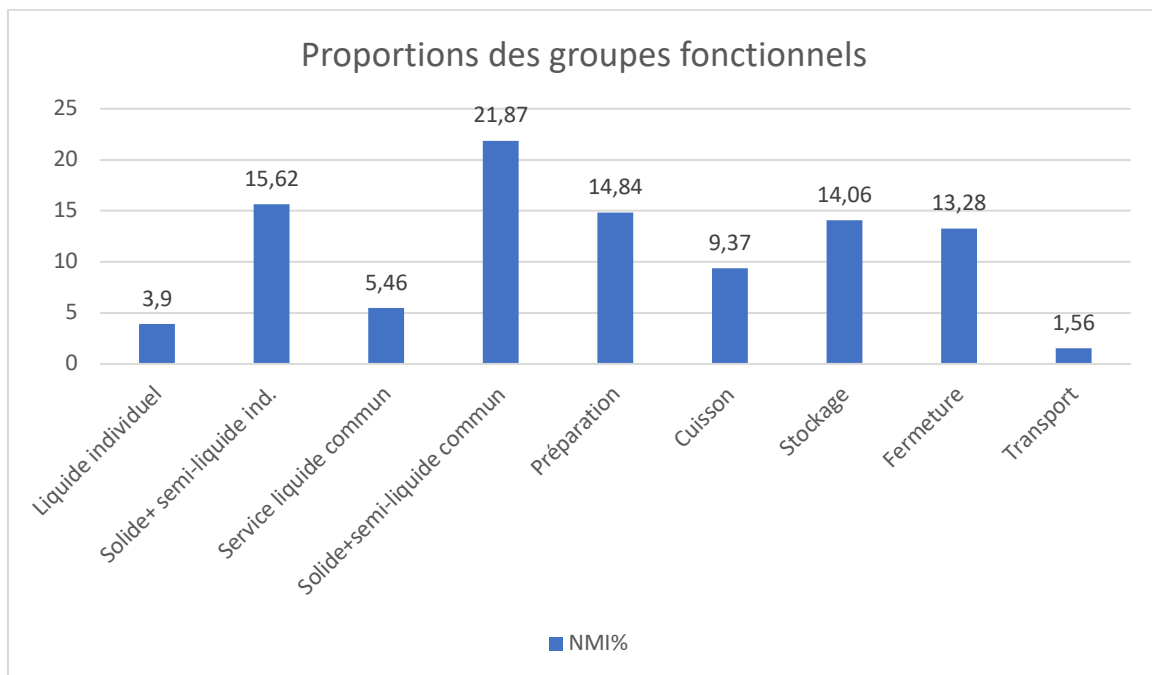
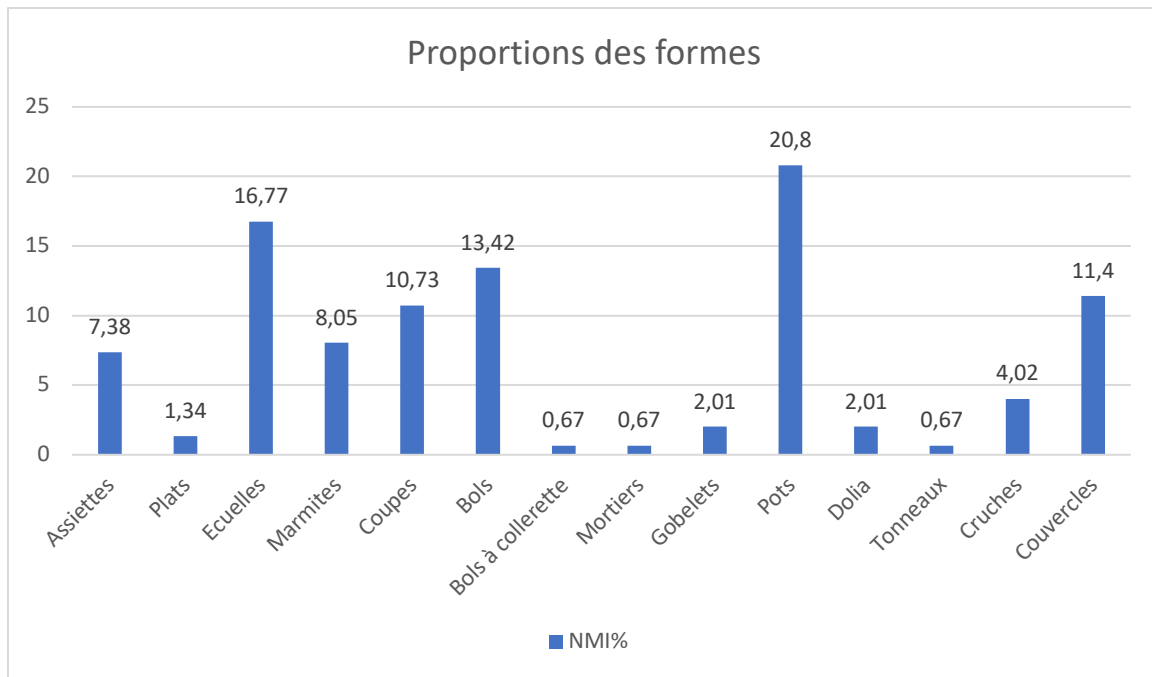


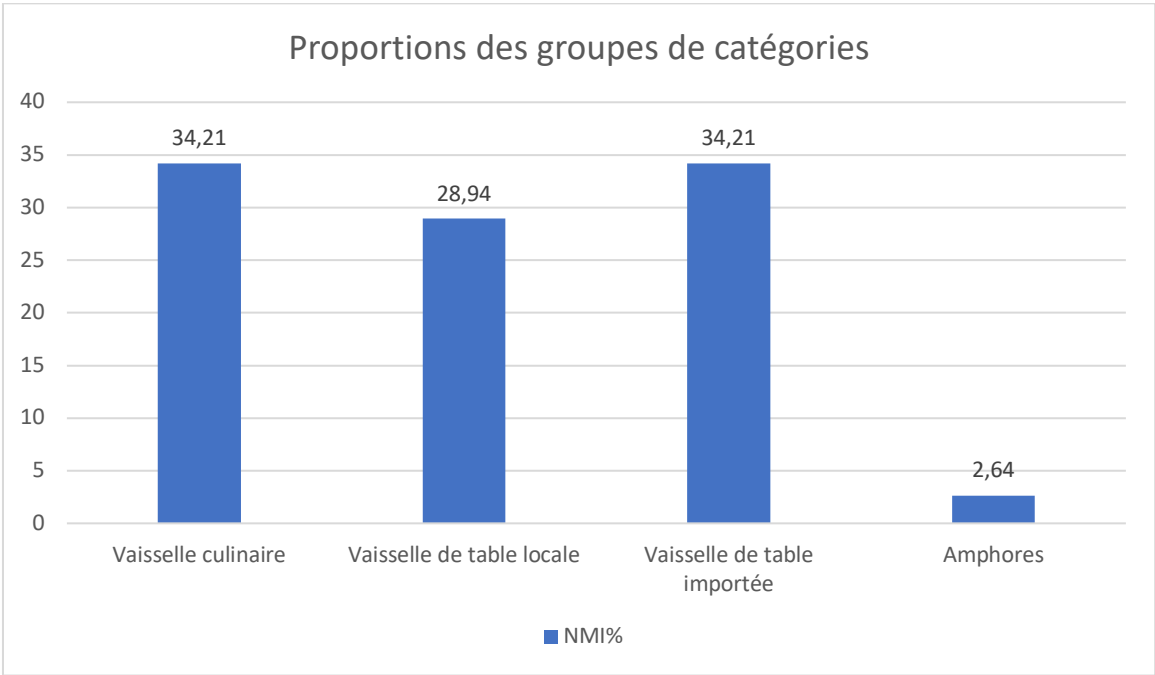
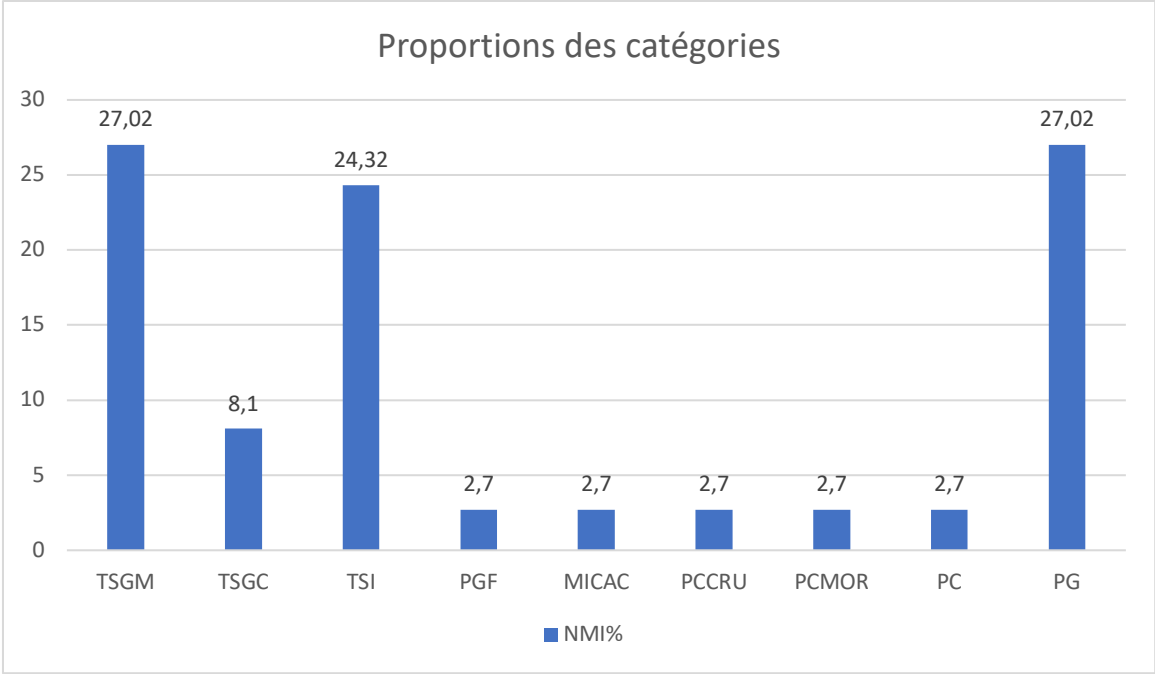
Fig.38: Local 18: pièce de séjour.

NMI	Catégories	%
10	TSGM	27,02
3	TSGC	8,1
9	TSI	24,32
1	PGF	2,7
1	MICAC	2,7
1	PCCRU	2,7
1	PCMOR	2,7
1	PC	2,7
10	PG	27,02
37		100%

NMI	Catégories	%
13	Vaisselle culinaire	34,21
11	Vaisselle de table locale	28,94
13	Vaisselle de table importée	34,21
1	Amphores	2,64
38		100%

NMI	Formes	%
7	Assiettes	21,21
3	Ecuelles	9,09
1	Marmites	3,03
1	Coupes	3,03
12	Bols	36,35
1	Bols à collerette	3,03
1	Mortiers	3,03
5	Pots	15,15
1	Cruches	3,03
1	Couvercles	3,03
33		100%

NMI	Fonctions	%
0	Consommation liquide individuel	0
12	Consommation solide+ semi-liquide ind.	35,29
1	Service liquide commun/stockage	2,94
12	Service solide+semi-liquide commun	35,29
1	Préparation	2,94
2	Cuisson	5,88
4	Stockage	11,76
1	Fermeture	2,94
1	Transport	2,94
34		100%



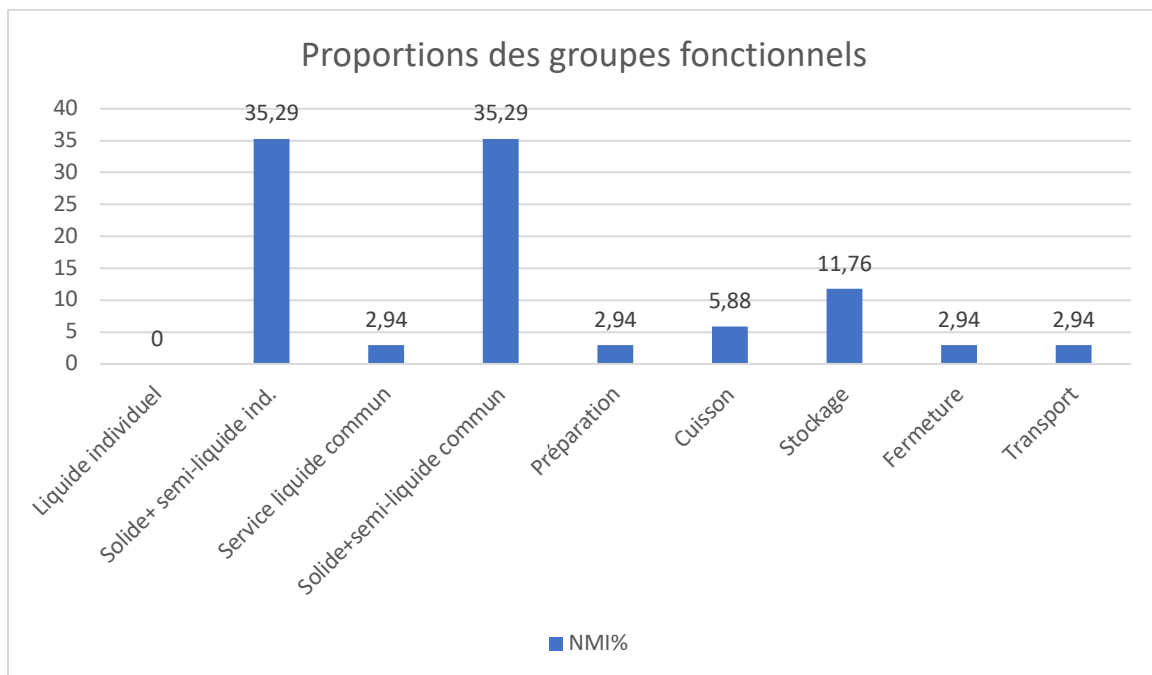
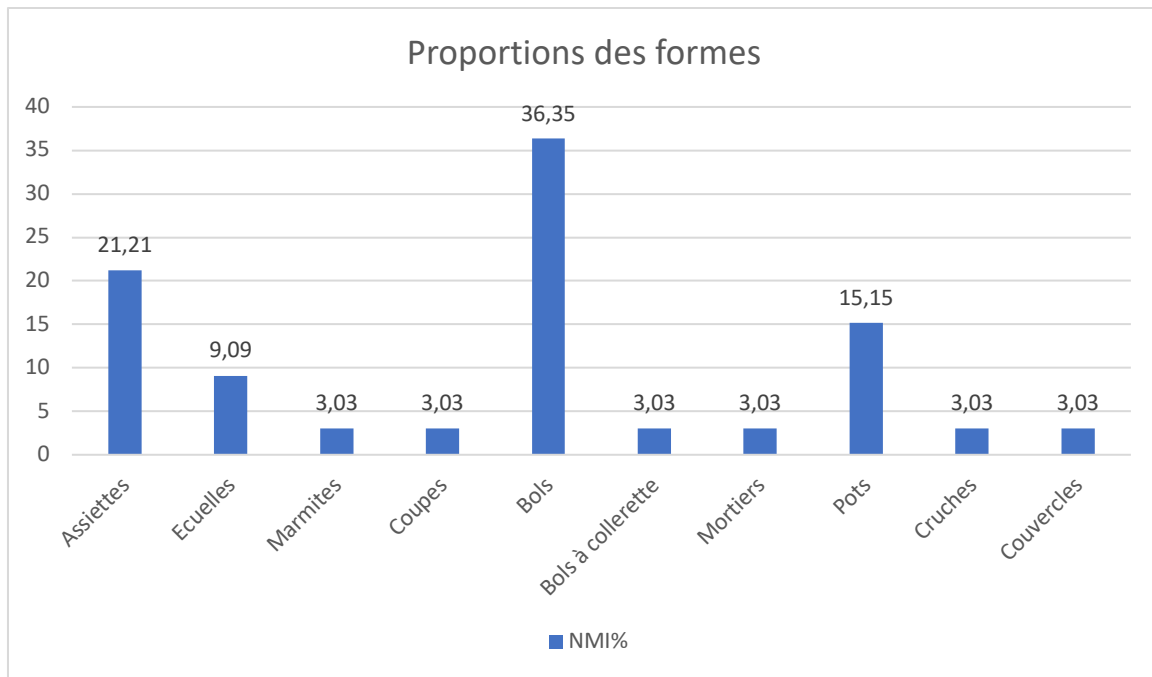


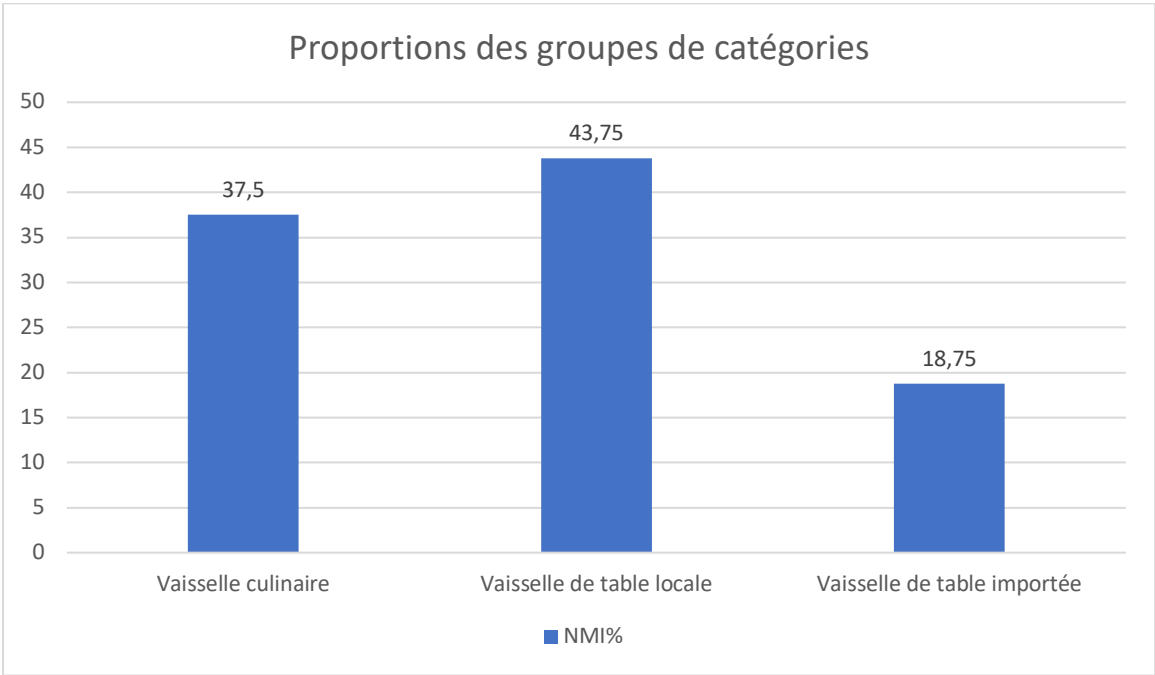
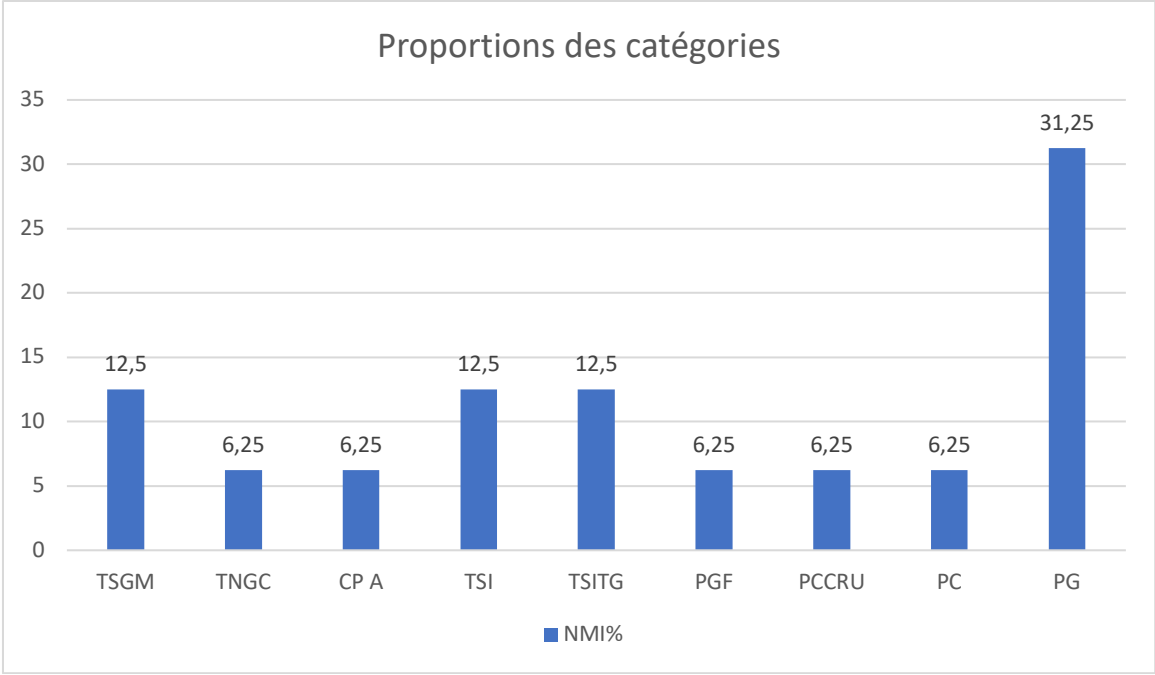
Fig.39: Local 20: indéterminé.

NMI	Catégories	%
2	TSGM	12,5
1	TNGC	6,25
1	CP A	6,25
2	TSI	12,5
2	TSITG	12,5
1	PGF	6,25
1	PCCRU	6,25
1	PC	6,25
5	PG	31,25
16		100%

NMI	Catégories	%
6	Vaisselle culinaire	37,5
7	Vaisselle de table locale	43,75
3	Vaisselle de table importée	18,75
16		100%

NMI	Formes	%
4	Assiettes	33,33
1	Ecuelles	8,33
1	Marmites	8,33
2	Bols	16,66
3	Pots	25
1	Cruches	8,33
12		100%

NMI	Fonctions	%
0	Consommation liquide individuel	0
3	Consommation solide+ semi-liquide ind.	25
1	Service liquide commun/stockage	8,33
4	Service solide+semi-liquide commun	33,33
0	Préparation	0
2	Cuisson	16,66
2	Stockage	16,66
0	Fermeture	0
0	Transport	0
12		100%



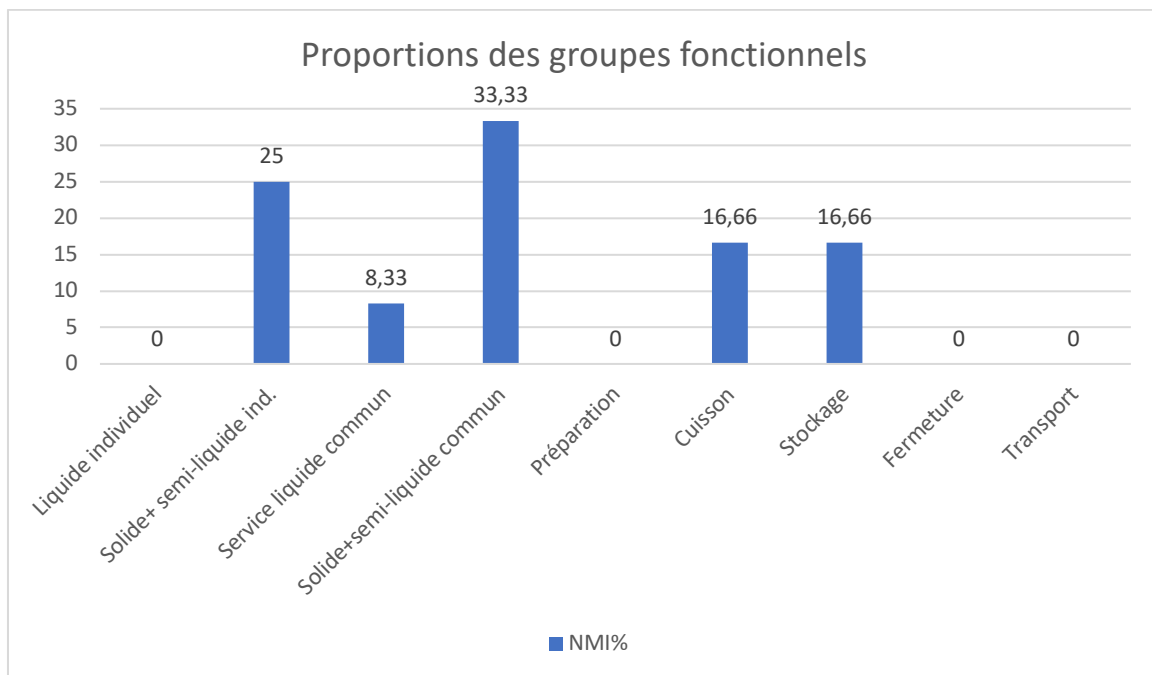
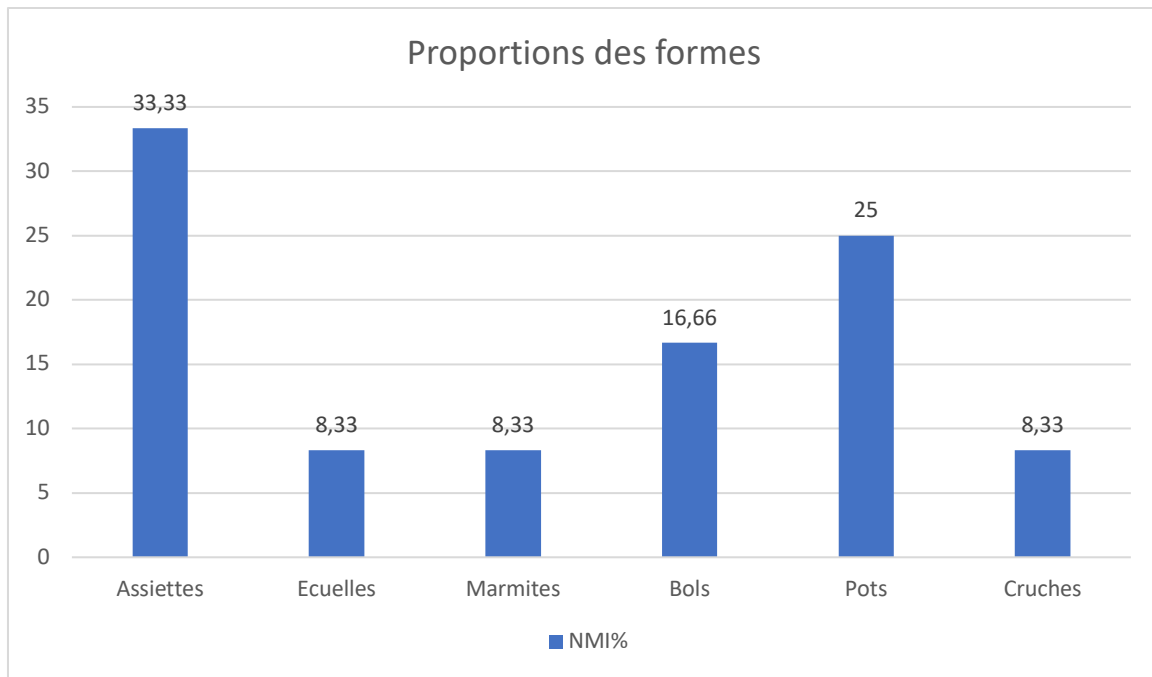


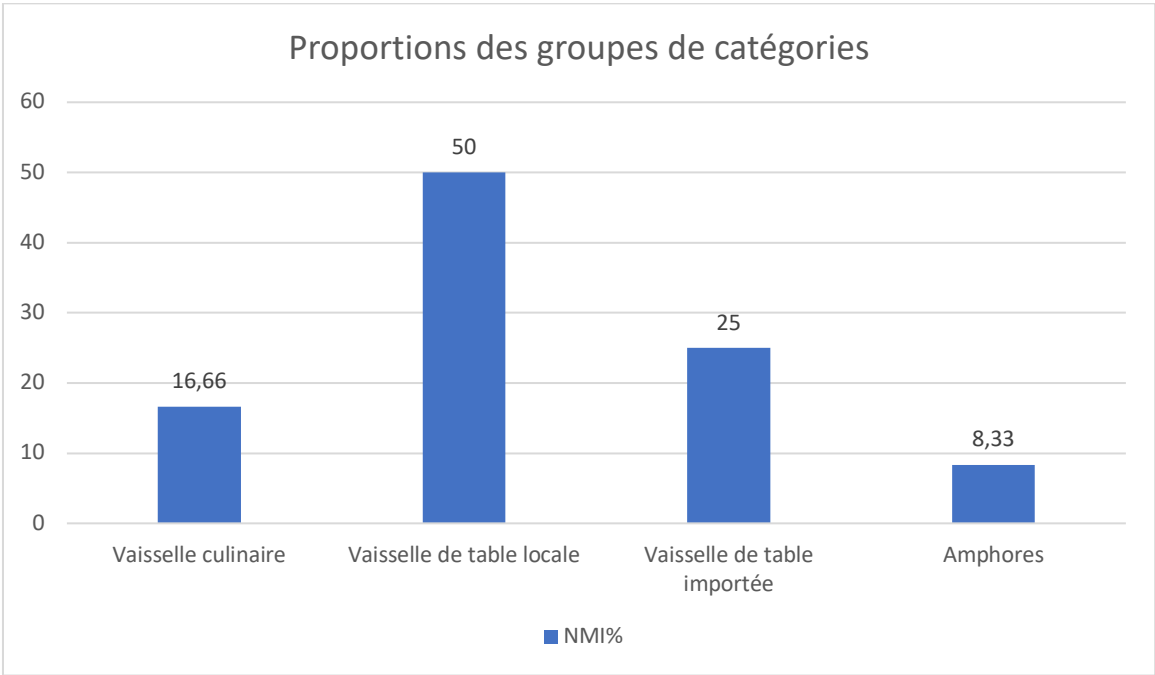
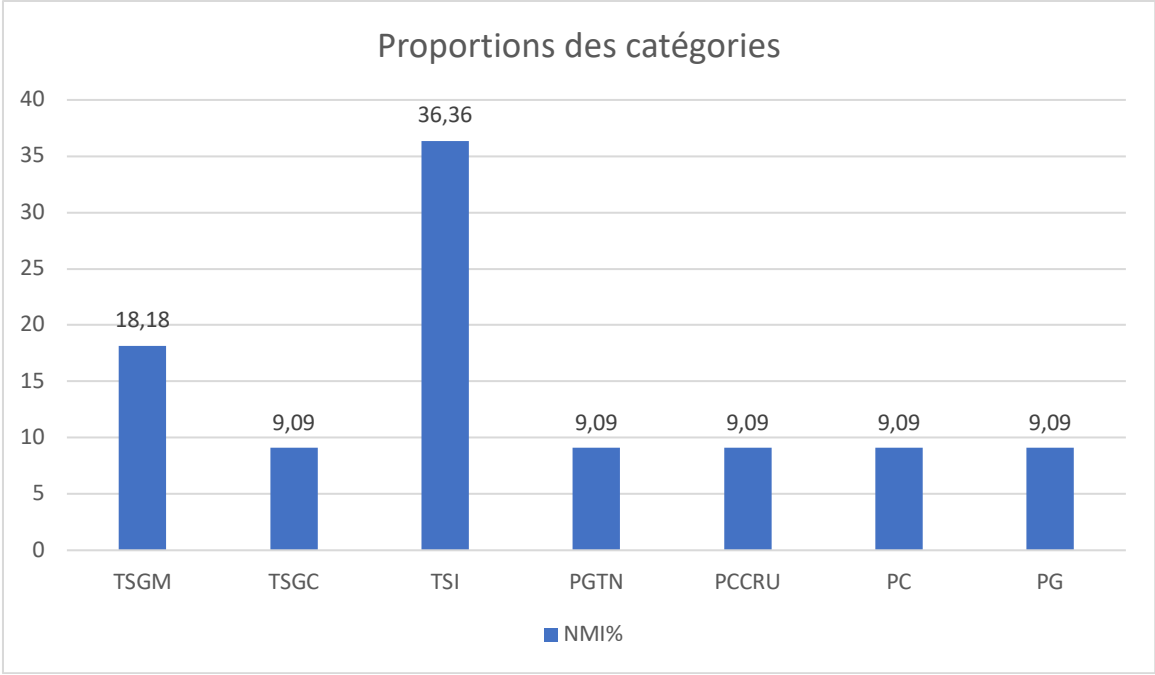
Fig.40: Local 21: échoppe, commerce alimentaire.

NMI	Catégories	%
2	TSGM	18,18
1	TSGC	9,09
4	TSI	36,36
1	PGTN	9,09
1	PCCRU	9,09
1	PC	9,09
1	PG	9,09
11		100%

NMI	Catégories	%
2	Vaisselle culinaire	16,66
6	Vaisselle de table locale	50
3	Vaisselle de table importée	25
1	Amphores	8,33
12		100%

NMI	Formes	%
1	Assiettes	12,5
1	Marmites	12,5
2	Coupes	25
3	Bols	37,5
1	Cruches	12,5
8		100%

NMI	Fonctions	%
0	Consommation liquide individuel	0
2	Consommation solide+ semi-liquide ind.	22,22
1	Service liquide commun/stockage	11,11
4	Service solide+semi-liquide commun	44,44
0	Préparation	0
1	Cuisson	11,11
0	Stockage	0
0	Fermeture	0
1	Transport	11,11
9		100%



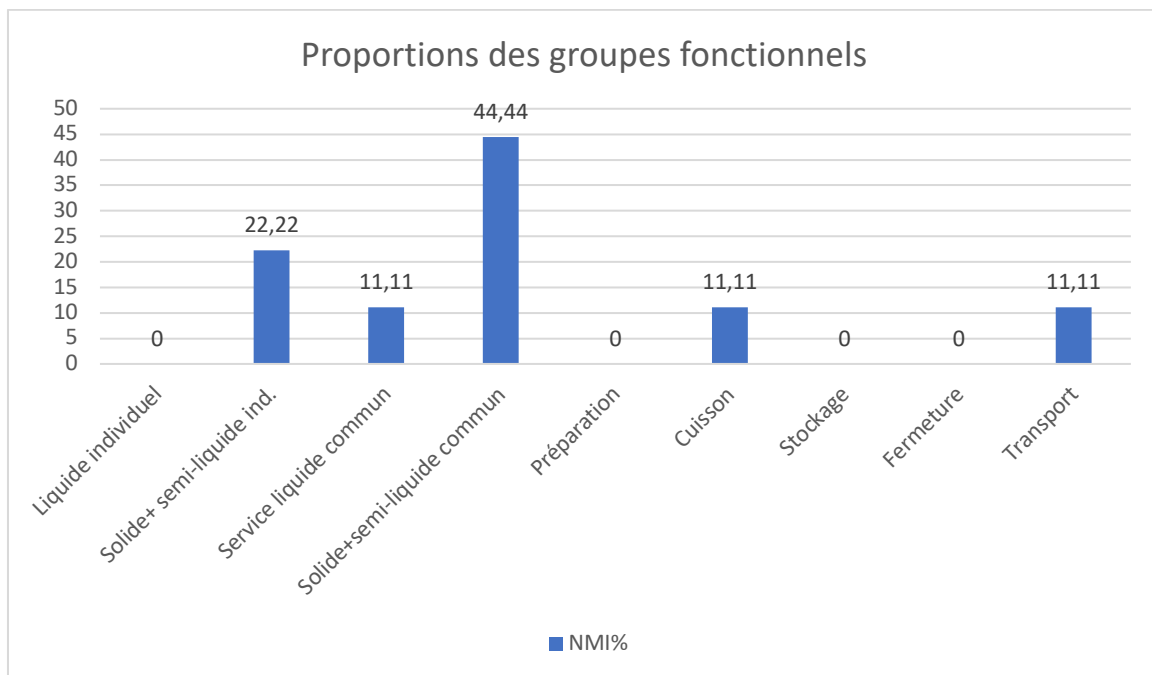
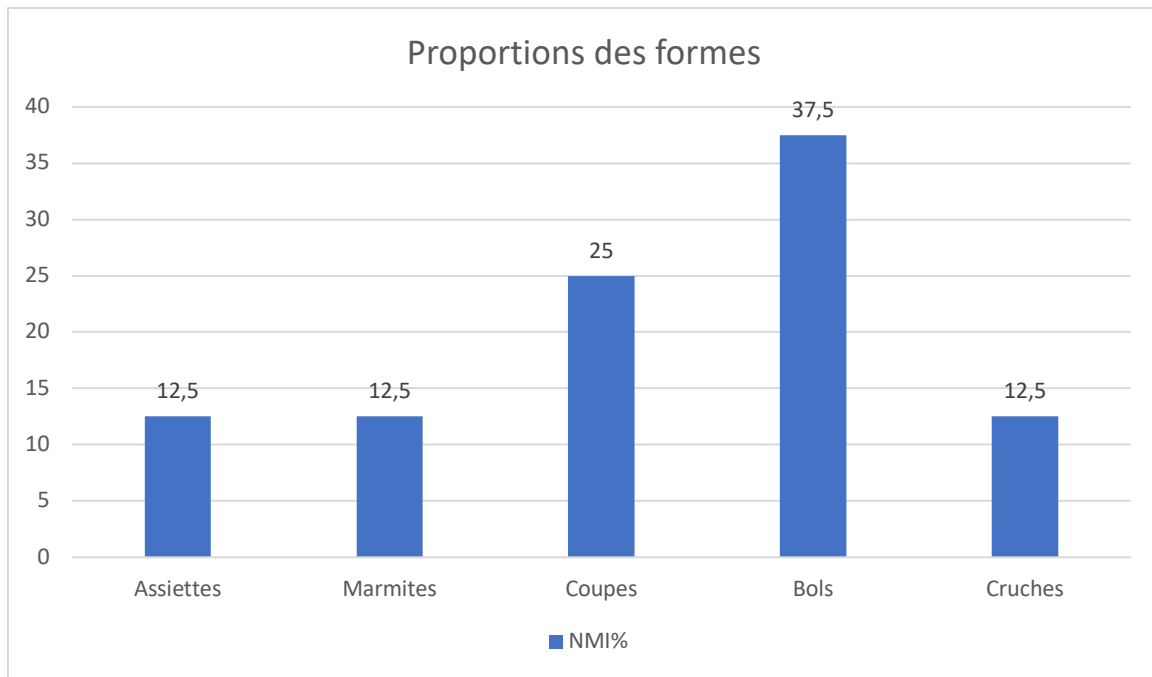


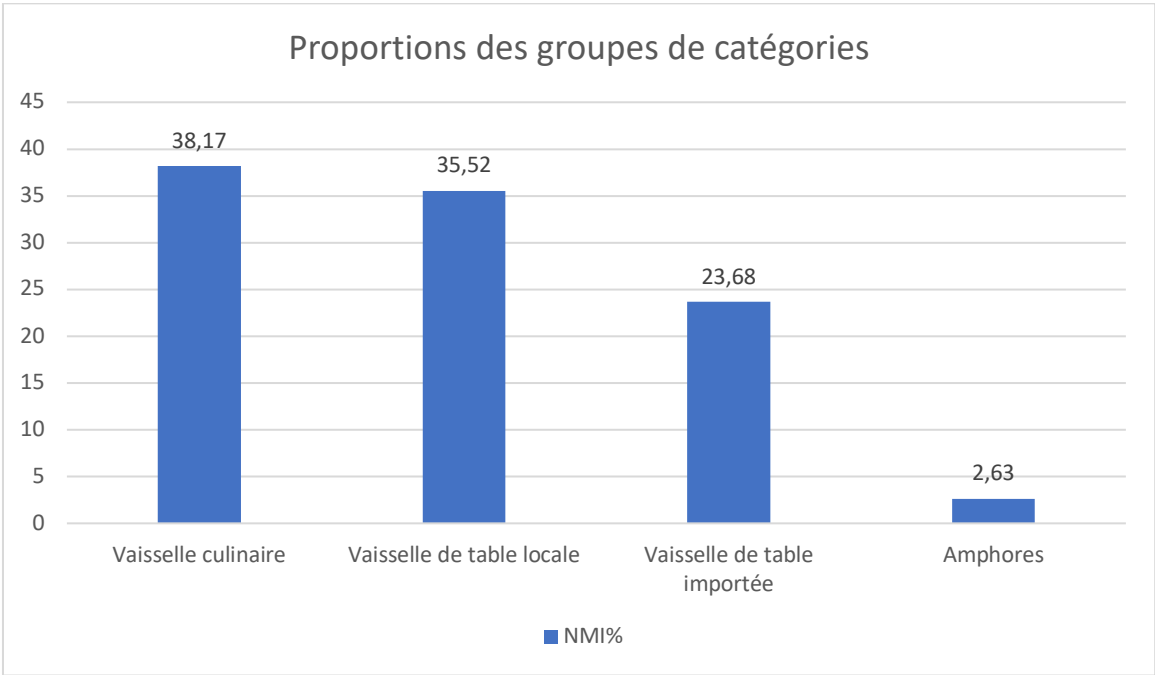
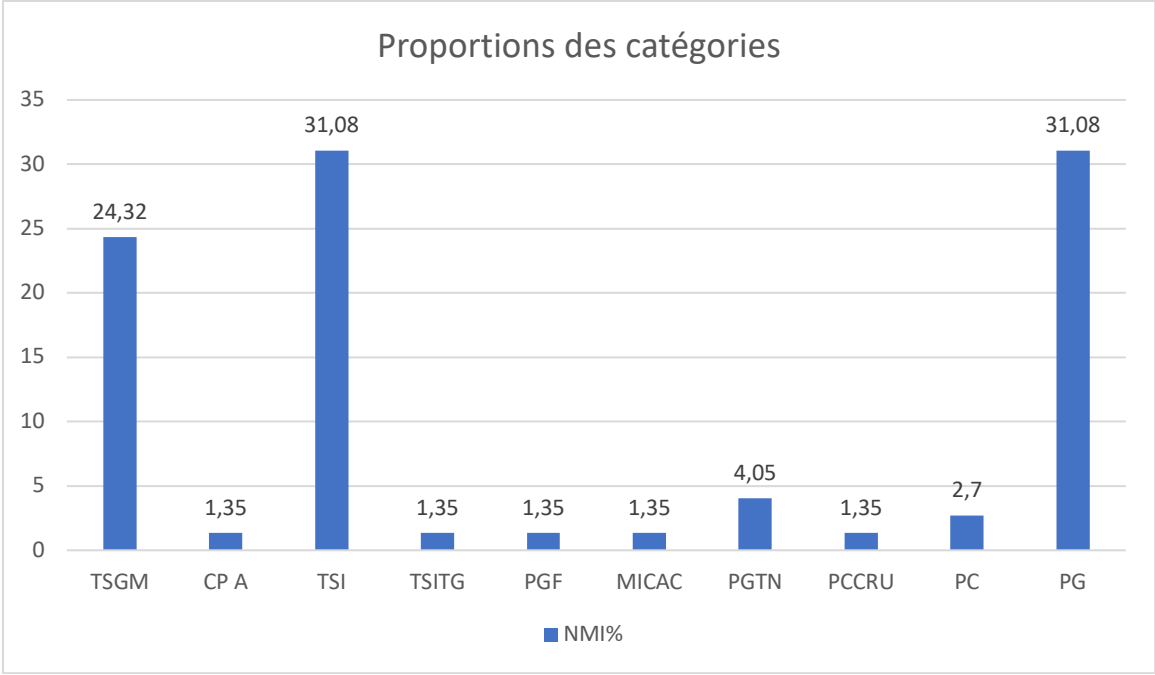
Fig.41: Local 22: cour.

NMI	Catégories	%
18	TSGM	24,32
1	CP A	1,35
23	TSI	31,08
1	TSITG	1,35
1	PGF	1,35
1	MICAC	1,35
3	PGTN	4,05
1	PCCRU	1,35
2	PC	2,7
23	PG	31,08
74		100%

NMI	Catégories	%
29	Vaisselle culinaire	38,17
27	Vaisselle de table locale	35,52
18	Vaisselle de table importée	23,68
2	Amphores	2,63

NMI	Formes	%
15	Assiettes	19,7
8	Ecuelles	10,52
4	Marmites	5,26
9	Coupes	11,84
19	Bols	25
14	Pots	18,42
1	<i>Dolia</i>	1,31
2	Tonneaux	2,63
1	Cruches	1,31
3	Couvercles	3,94
76		100%

NMI	Fonctions	%
0	Consommation liquide individuel	0
25	Consommation solide+ semi-liquide ind.	32,05
3	Service liquide commun/stockage	3,84
26	Service solide+semi-liquide commun	33,36
0	Préparation	0
10	Cuisson	12,82
9	Stockage	11,53
3	Fermeture	3,84
2	Transport	2,56
78		100%



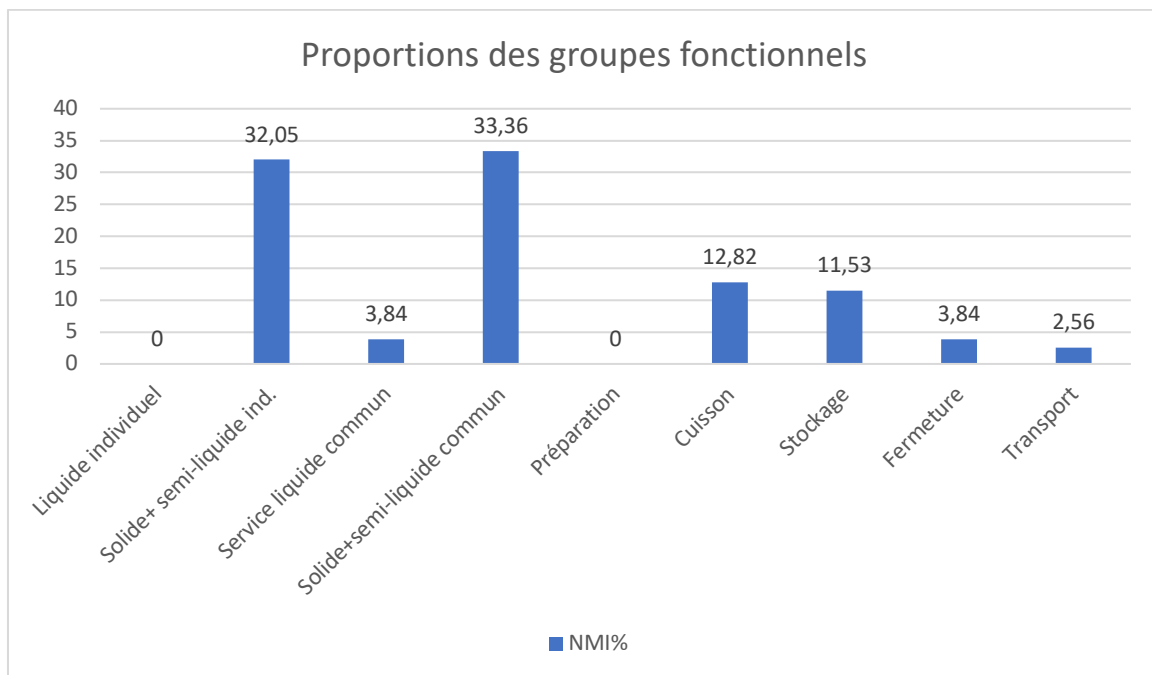
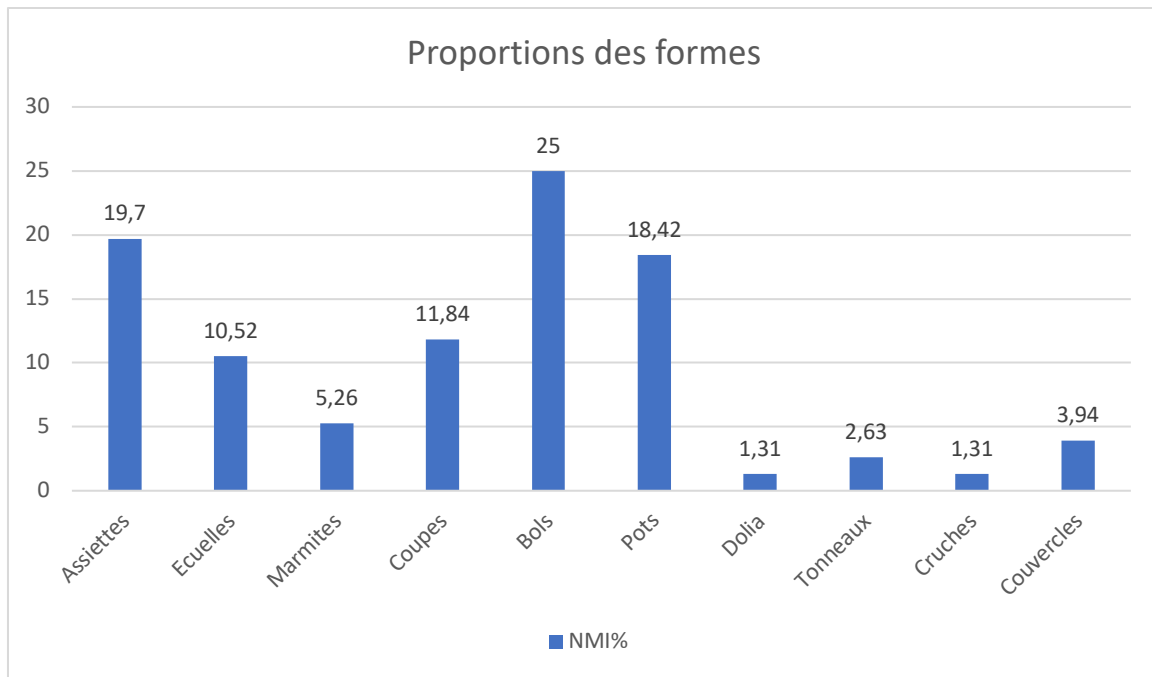


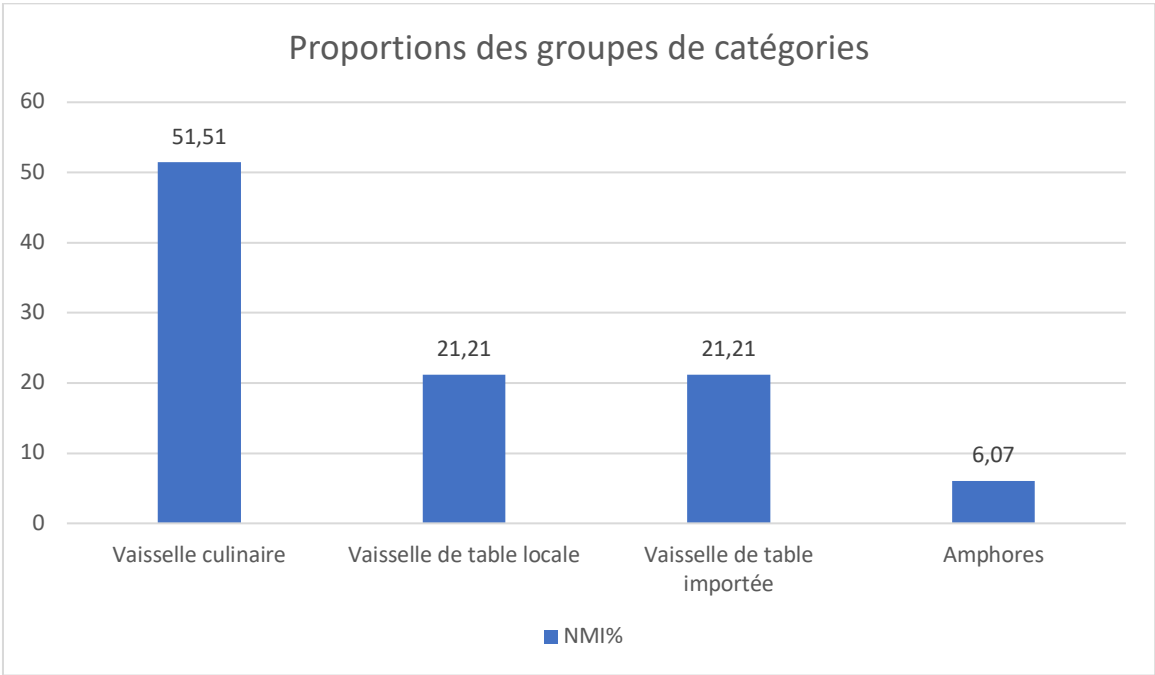
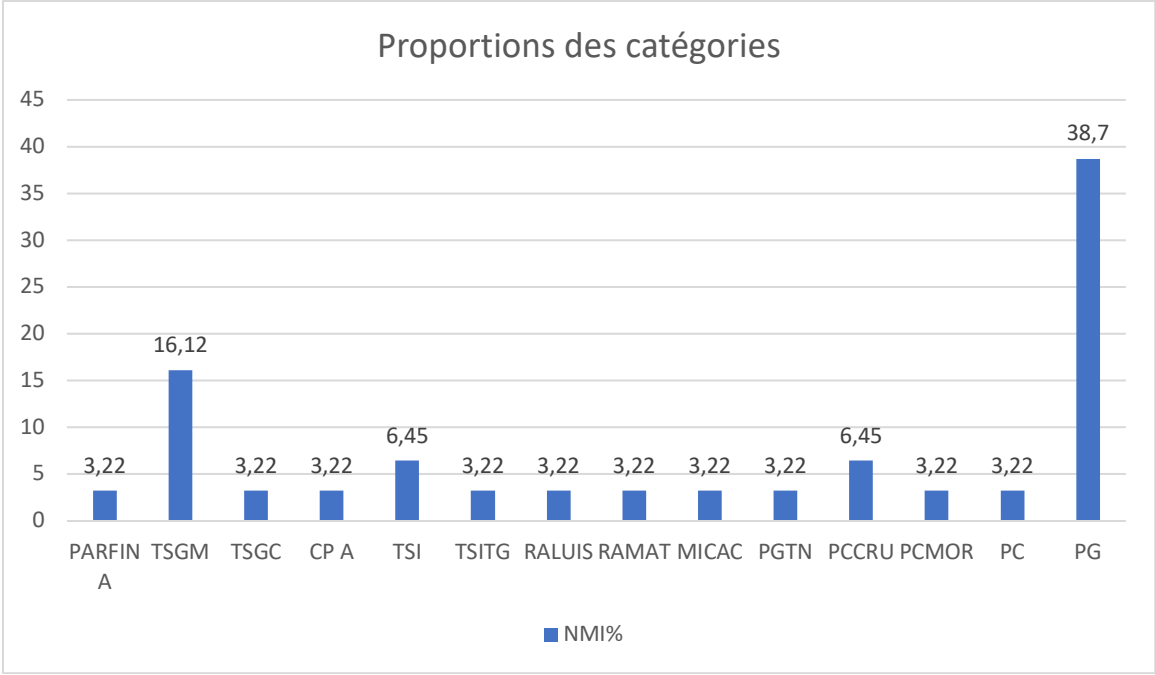
Fig.42: Local 24: pièce de séjour.

NMI	Catégories	%
1	PARFIN A	3,22
5	TSGM	16,12
1	TSGC	3,22
1	CP A	3,22
2	TSI	6,45
1	TSITG	3,22
1	RALUIS	3,22
1	RAMAT	3,22
1	MICAC	3,22
1	PGTN	3,22
2	PCCRU	6,45
1	PCMOR	3,22
1	PC	3,22
12	PG	38,7
31		100%

NMI	Catégories	%
17	Vaisselle culinaire	51,51
7	Vaisselle de table locale	21,21
7	Vaisselle de table importée	21,21
2	Amphores	6,07
33		100%

NMI	Formes	%
2	Assiettes	8,69
4	Ecuelles	17,39
3	Coupes	13,04
2	Bols	8,69
1	Mortiers	4,34
1	Gobelets	4,34
3	Pots	13,04
1	<i>Dolia</i>	4,34
2	Cruches	8,69
4	Couvercles	17,39
23		100%

NMI	Fonctions	%
1	Consommation liquide individuel	4
6	Consommation solide+ semi-liquide ind.	24
2	Service liquide commun/stockage	8
5	Service solide+semi-liquide commun	20
1	Préparation	4
0	Cuisson	0
4	Stockage	16
4	Fermeture	16
2	Transport	8
25		100%



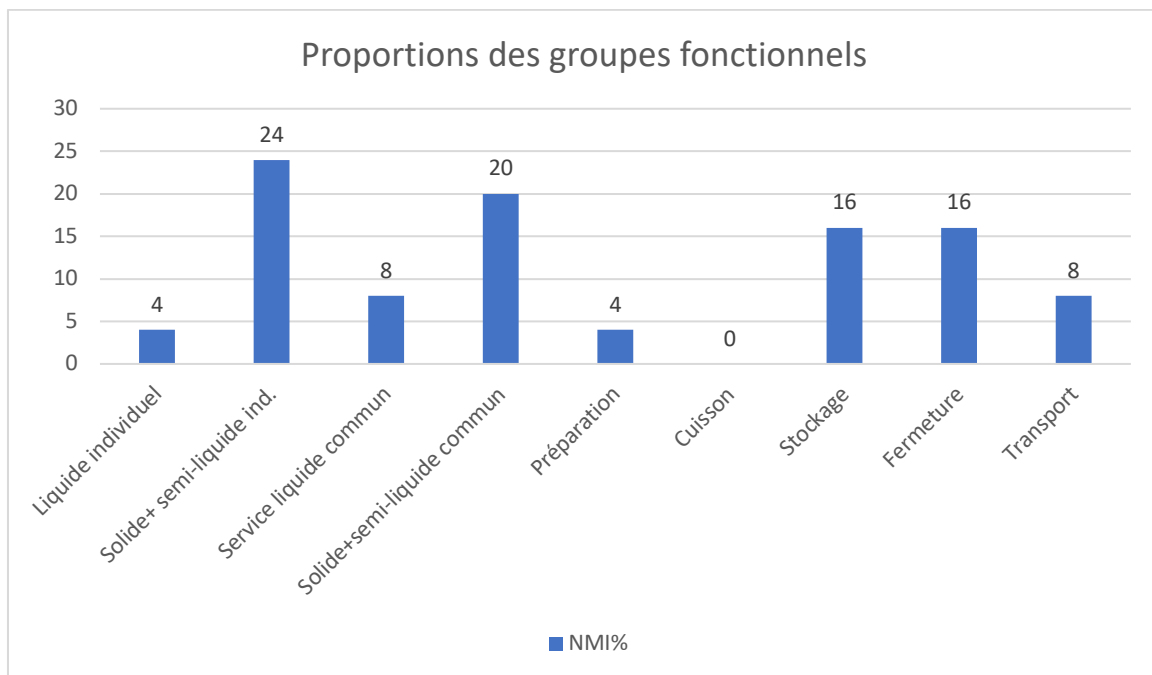
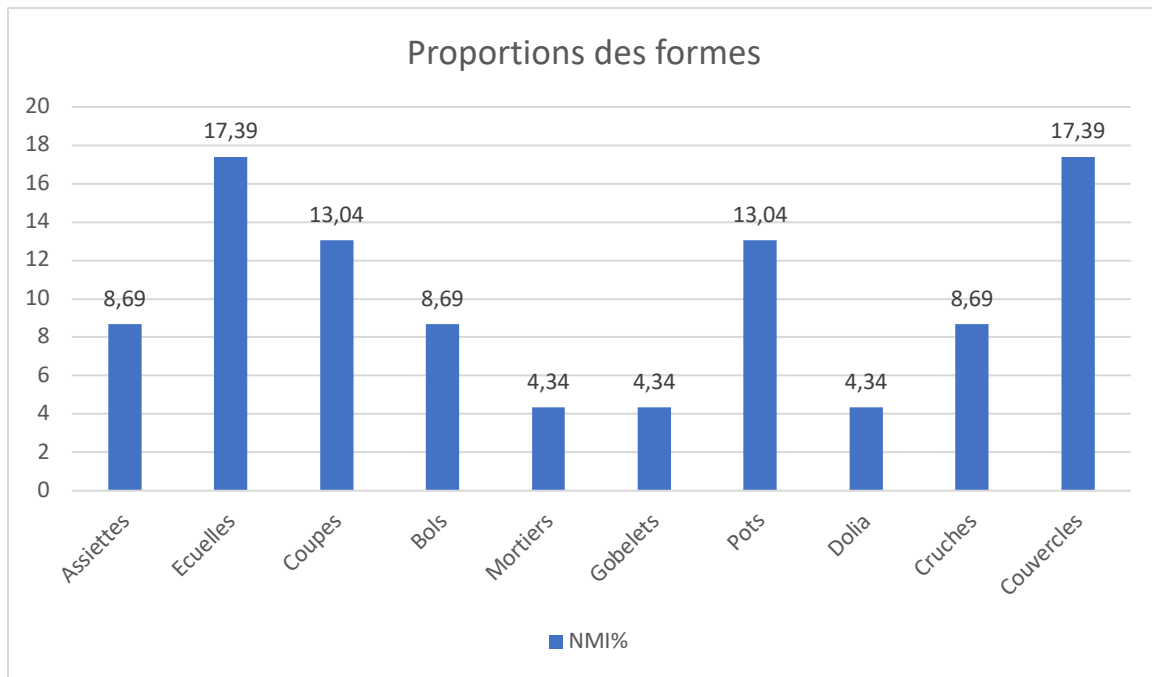


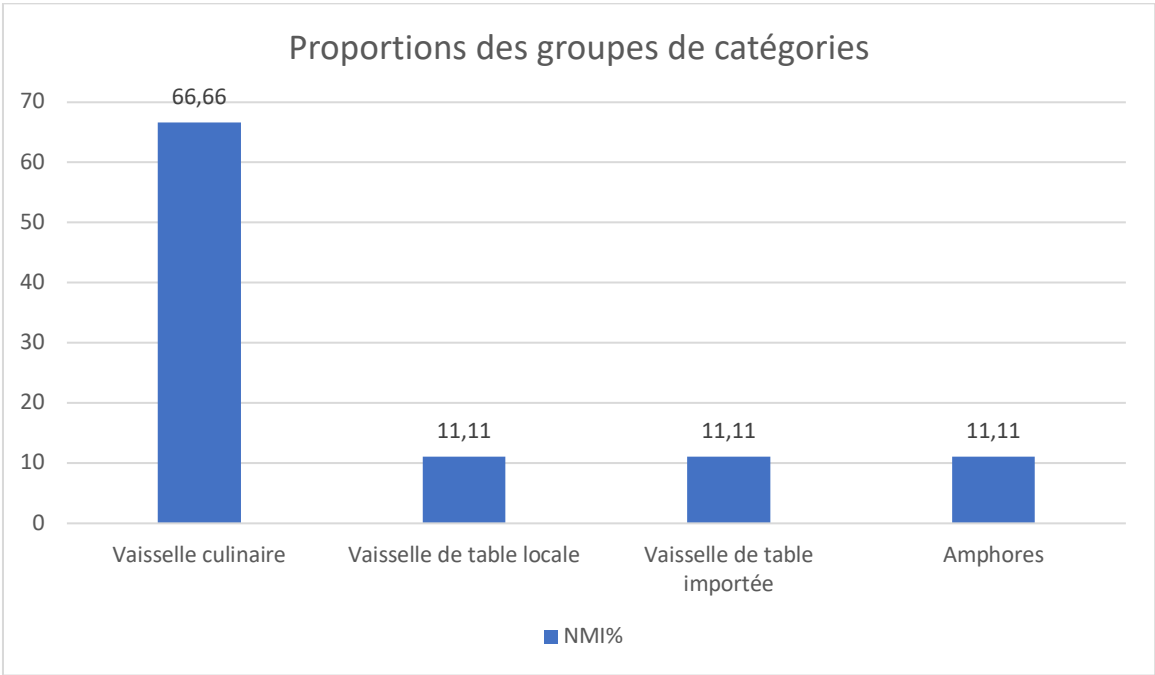
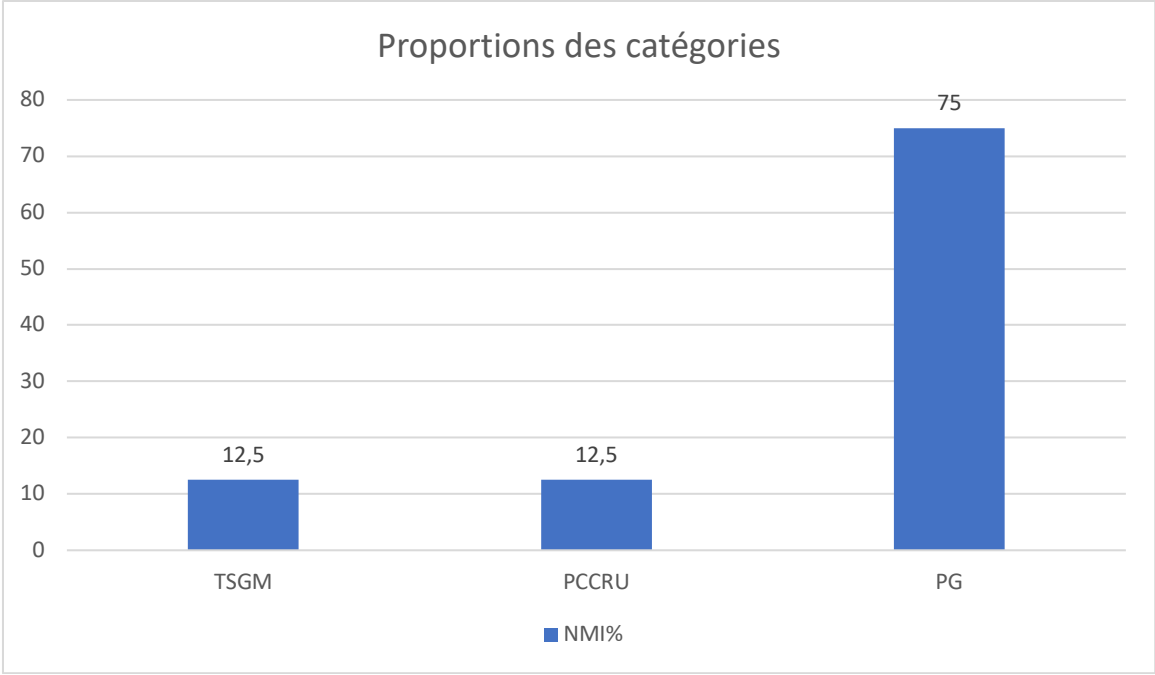
Fig.43: Local 26: indéterminé.

NMI	Catégories	%
1	TSGM	12,5
1	PCCRU	12,5
6	PG	75
8		100%

NMI	Catégories	%
6	Vaisselle culinaire	66,66
1	Vaisselle de table locale	11,11
1	Vaisselle de table importée	11,11
1	Amphores	11,11
9		100%

NMI	Formes	%
3	Ecuelles	33,33
2	Marmites	22,22
1	Coupes	11,11
1	Pots	11,11
1	Cruches	11,11
1	Couvercles	11,11
9		100%

NMI	Fonctions	%
0	Consommation liquide individuel	0
3	Consommation solide+ semi-liquide ind.	30
1	Service liquide commun/stockage	10
1	Service solide+semi-liquide commun	10
0	Préparation	0
2	Cuisson	20
1	Stockage	10
1	Fermeture	10
1	Transport	10
10		100%



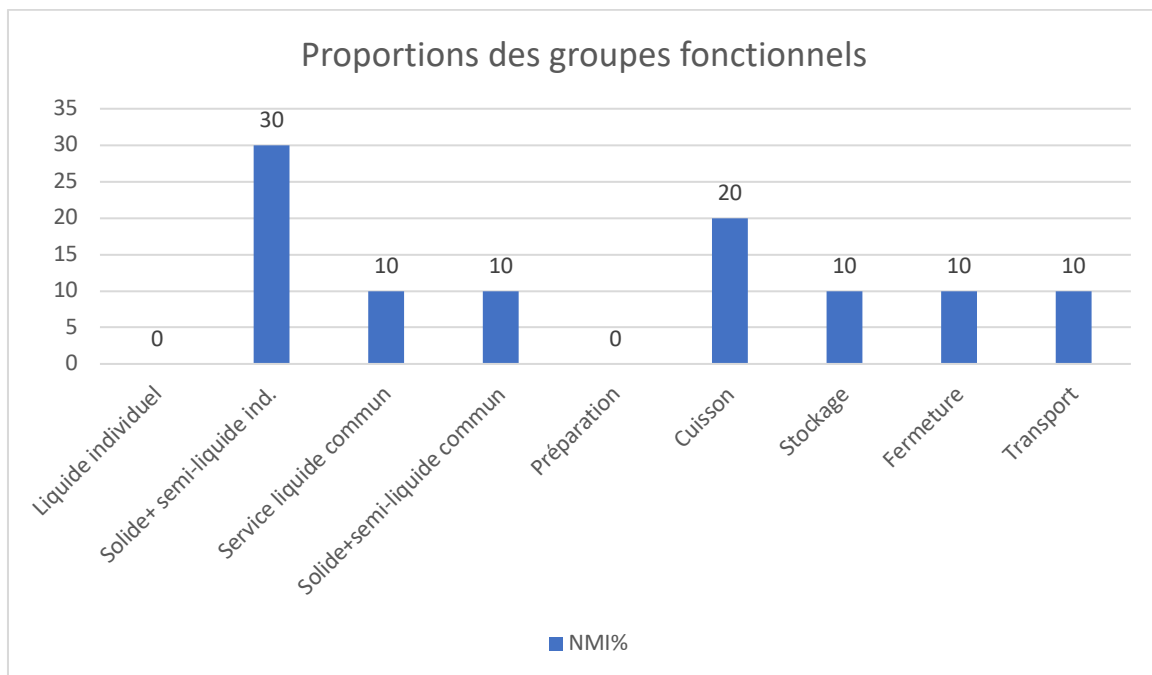
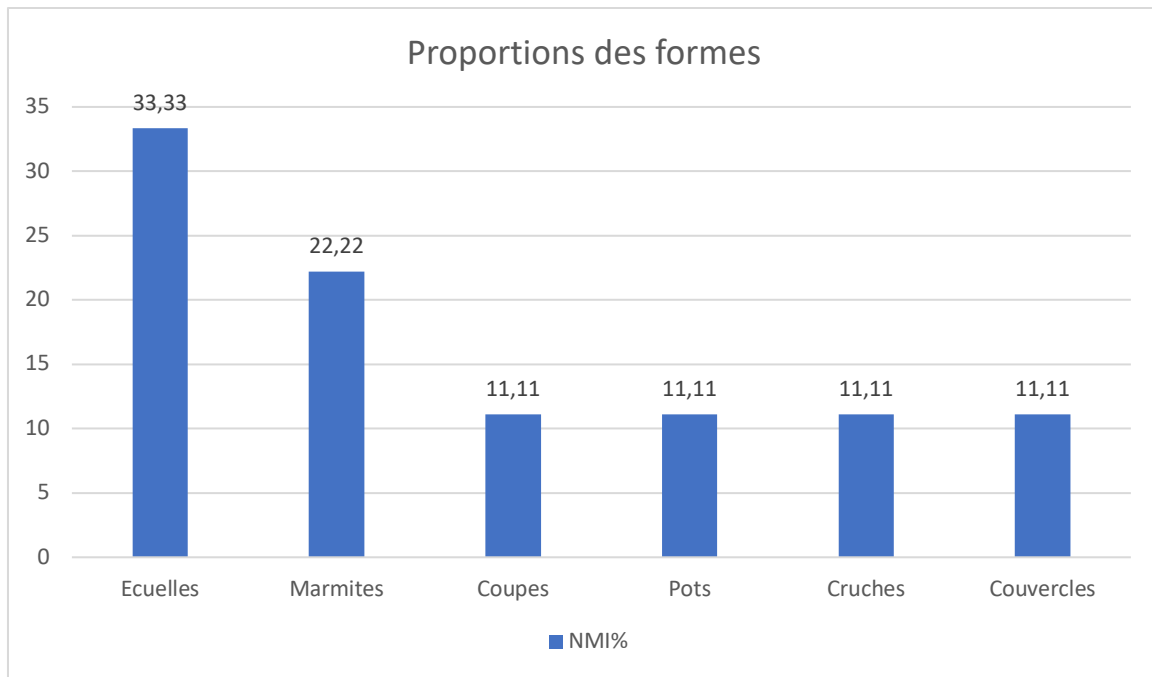
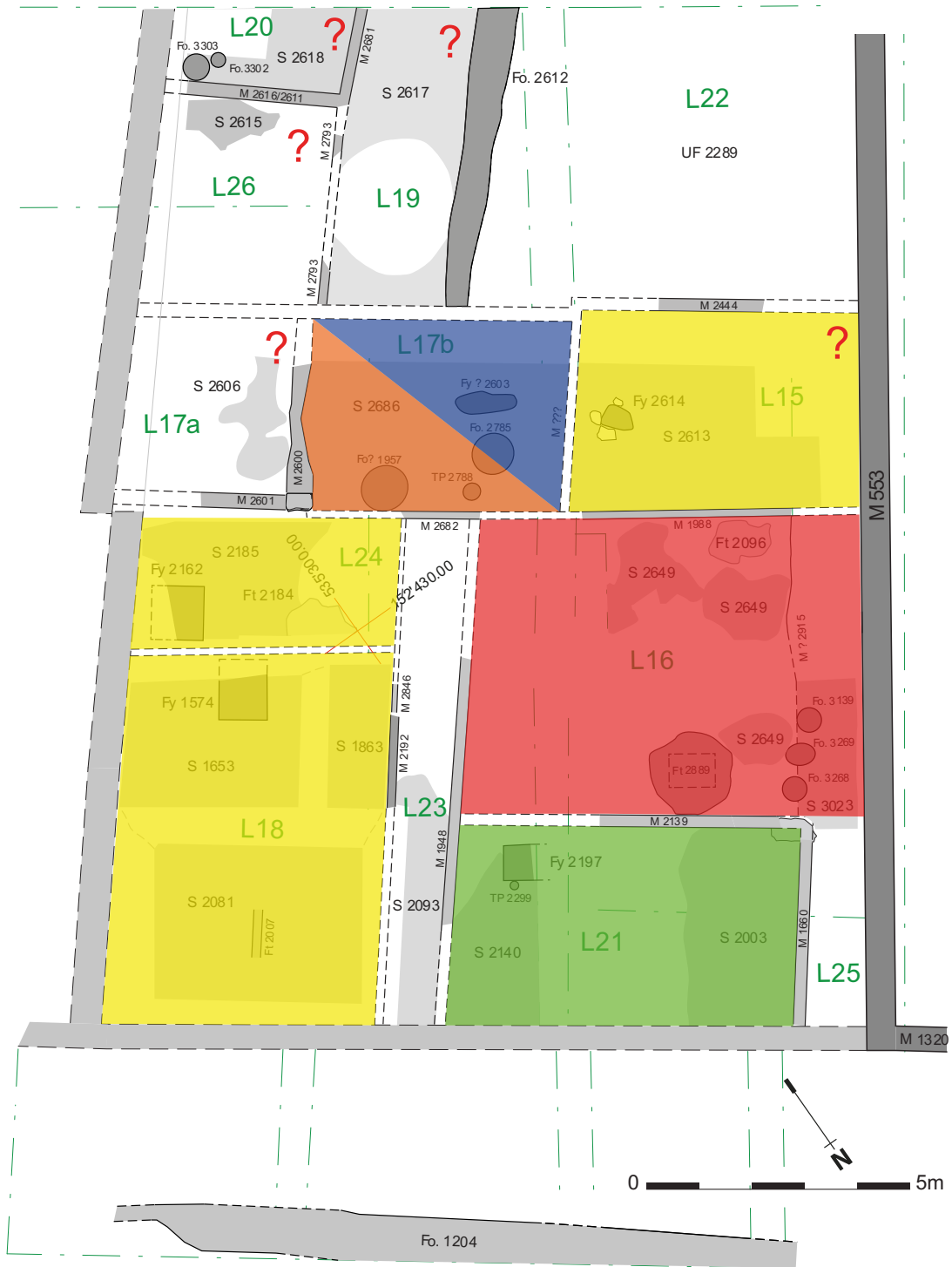


Fig.44: Proposition d'attribution fonctionnelle des locaux de la période D-2.



- | | |
|--|---|
| Séjour (domestique) | Stockage |
| Cuisine (domestique) | Echoppe (commerce alimentaire ?) |
| Atelier artisanal (boucherie ? artisanat culinaire ?) | Cours, couloirs |

4.2.3. Période D-3 (180 ap. J.-C.)

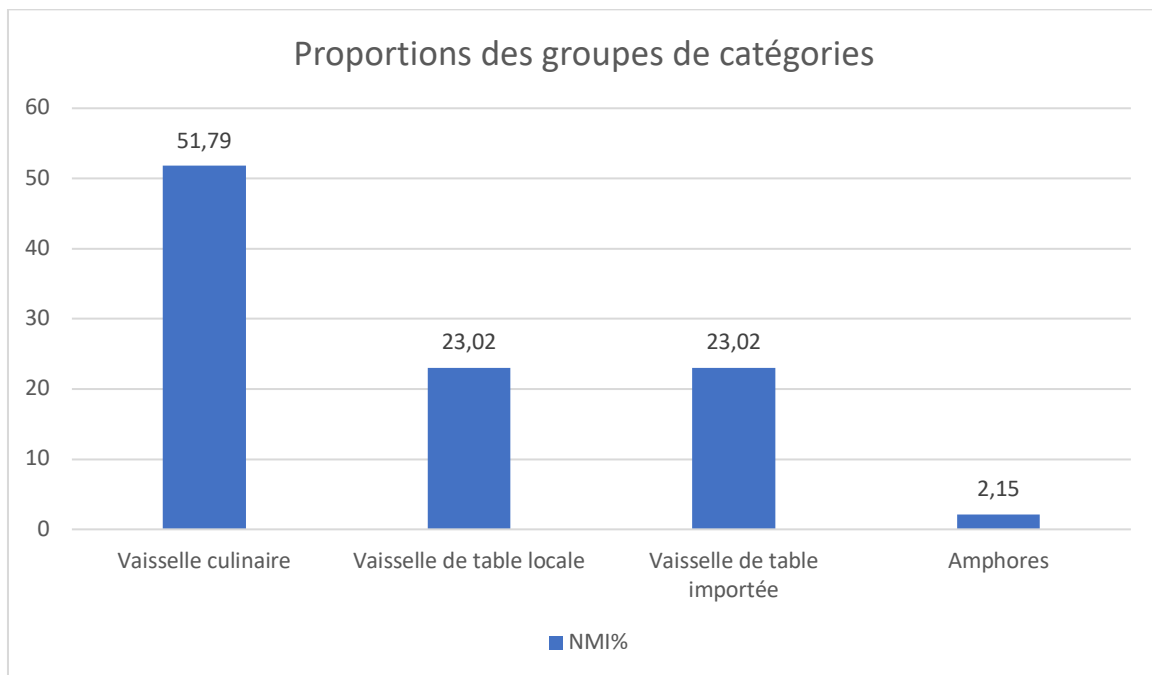
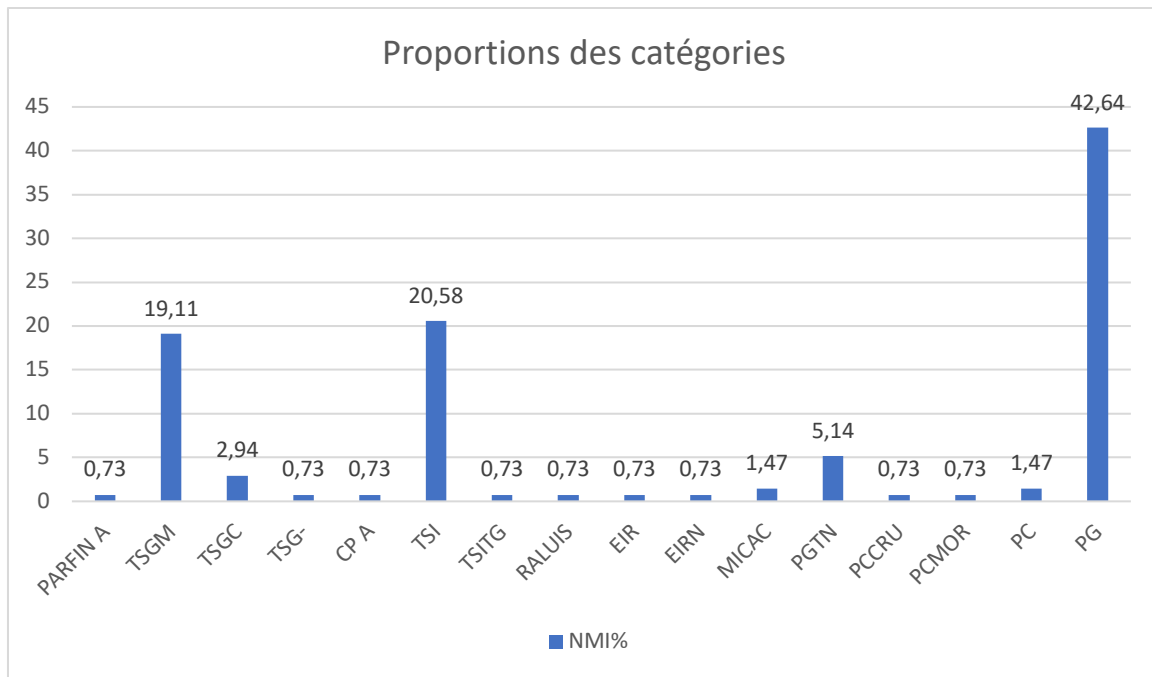
Fig. 45: Local 16: atelier artisanal (boucherie, artisanat culinaire ?).

NMI	Catégories	%
1	PARFIN A	0,73
26	TSGM	19,11
4	TSGC	2,94
1	TSG-	0,73
1	CP A	0,73
28	TSI	20,58
1	TSITG	0,73
1	RALUIS	0,73
1	EIR	0,73
1	EIRN	0,73
2	MICAC	1,47
7	PGTN	5,14
1	PCCRU	0,73
1	PCMOR	0,73
2	PC	1,47
58	PG	42,64
136		100%

NMI	Catégories	%
72	Vaisselle culinaire	51,79
32	Vaisselle de table locale	23,02
32	Vaisselle de table importée	23,02
3	Amphores	2,15
139		100%

NMI	Formes	%
24	Assiettes	17,64
2	Plats	1,47
26	Ecuellen	19,11
1	Marmites	0,73
12	Coupes	8,82
24	Bols	17,68
1	Bols à collerette	0,73
1	Mortiers	0,73
3	Gobelets	2,2
21	Pots	15,44
1	Cruches	0,73
19	Couvercles	13,97
1	Jetons	0,73
136		100%

NMI	Fonctions	%
3	Consommation liquide individuel	2,23
47	Consommation solide+ semi-liquide ind.	35,07
1	Service liquide commun/stockage	0,74
40	Service solide+semi-liquide commun	29,85
1	Préparation	0,74
10	Cuisson	7,46
14	Stockage	10,44
15	Fermeture	11,19
3	Transport	2,23
134		100%



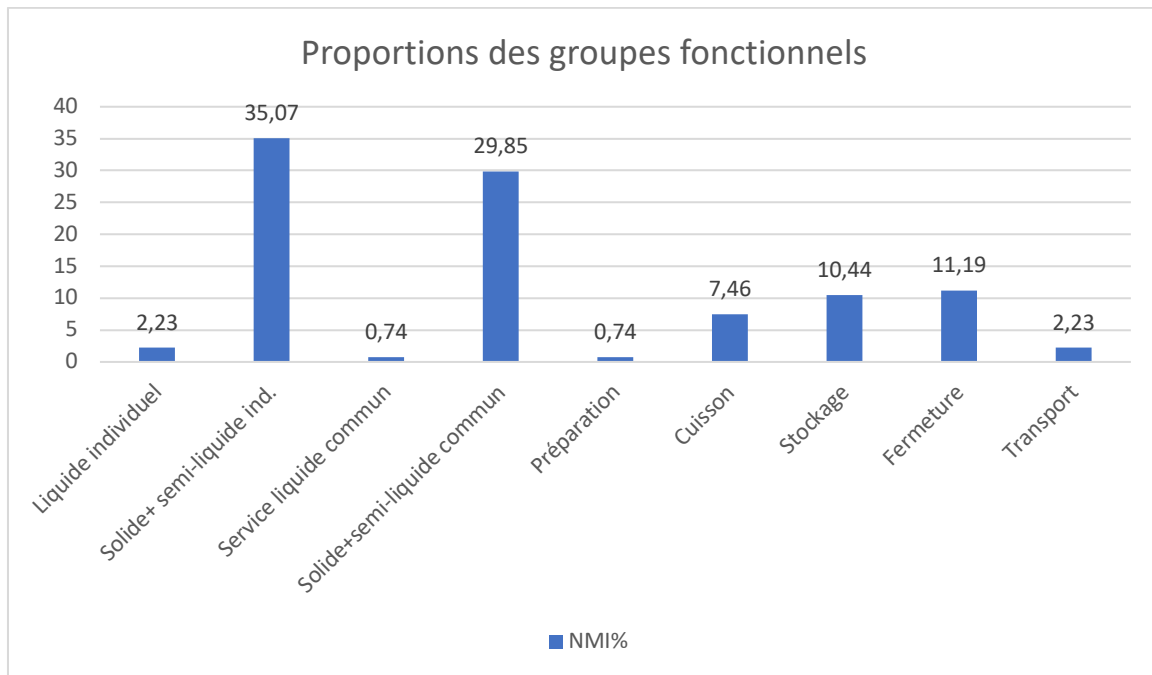
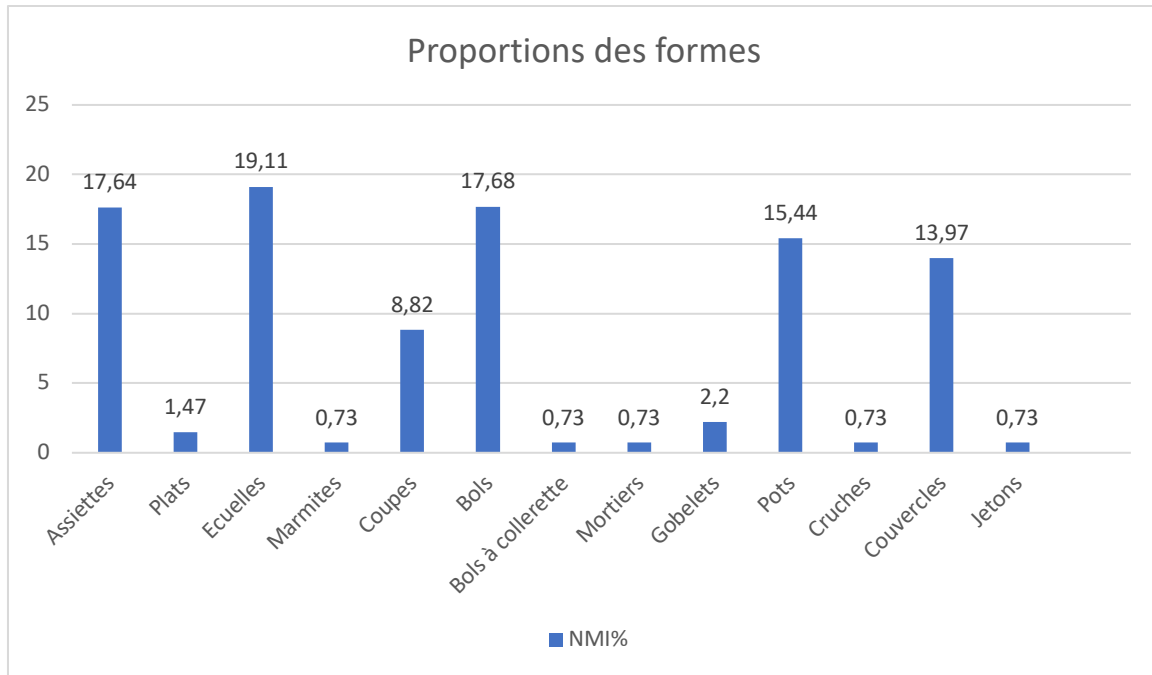


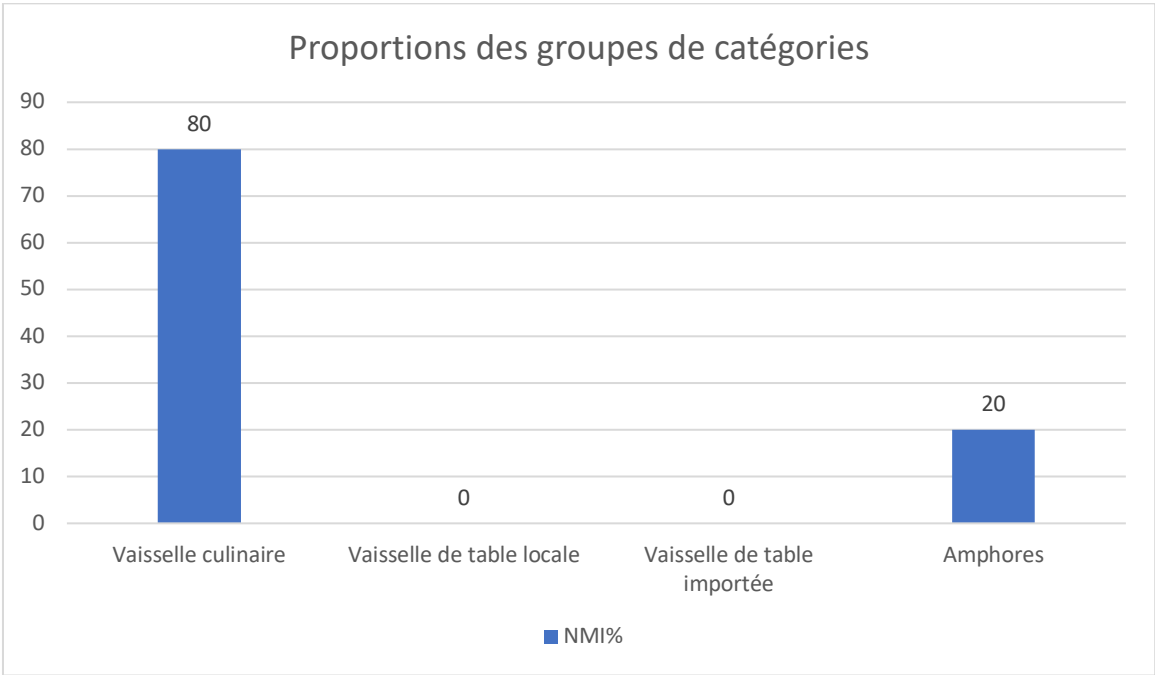
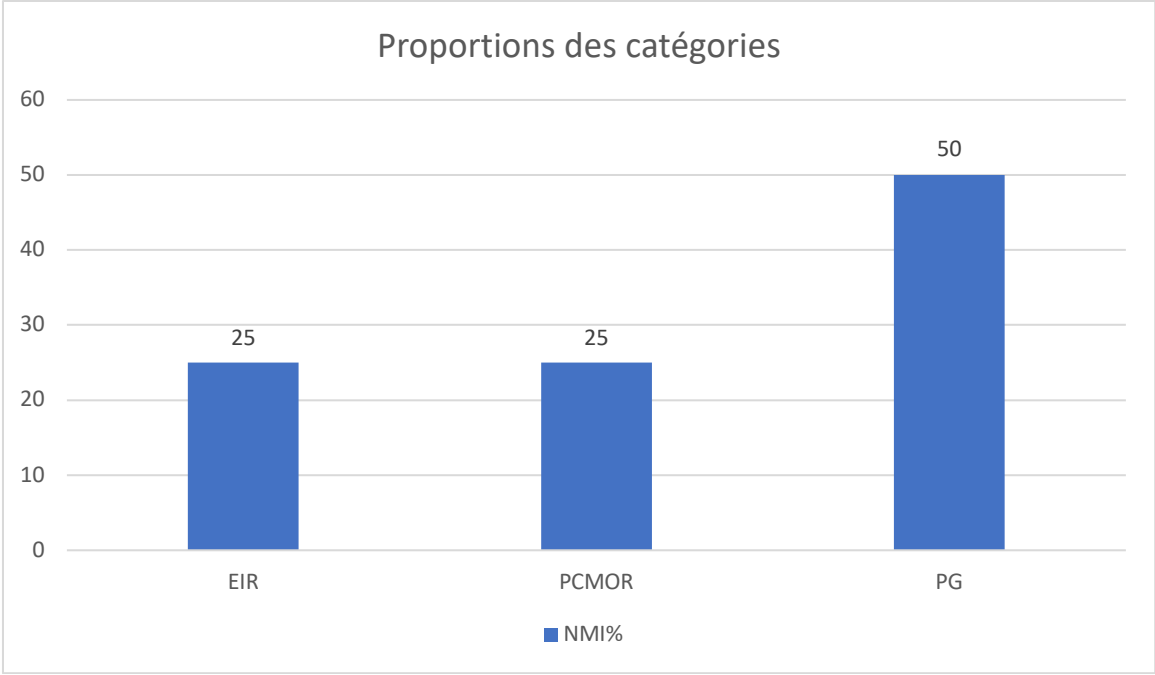
Fig. 46: Local 17a et local 24: indéterminé (stockage ?).

NMI	Catégories	%
1	EIR	25
1	PCMOR	25
2	PG	50
4		100%

NMI	Catégories	%
4	Vaisselle culinaire	80
0	Vaisselle de table locale	0
0	Vaisselle de table importée	0
1	Amphores	20
5		100%

NMI	Formes	%
1	Plats	25
1	Ecuelles	25
1	Mortiers	25
1	Pots	25
4		100%

NMI	Fonctions	%
0	Consommation liquide individuel	0
1	Consommation solide+ semi-liquide ind.	25
0	Service liquide commun/stockage	0
0	Service solide+semi-liquide commun	0
1	Préparation	25
1	Cuisson	25
0	Stockage	0
0	Fermeture	0
1	Transport	25
4		100%



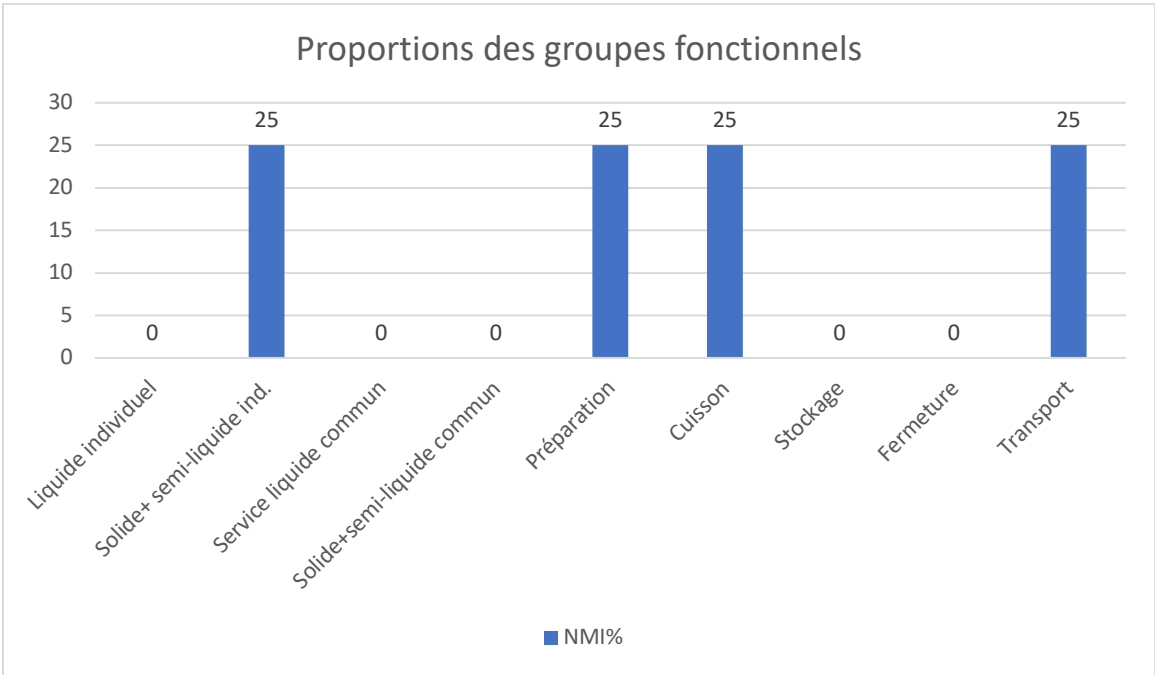
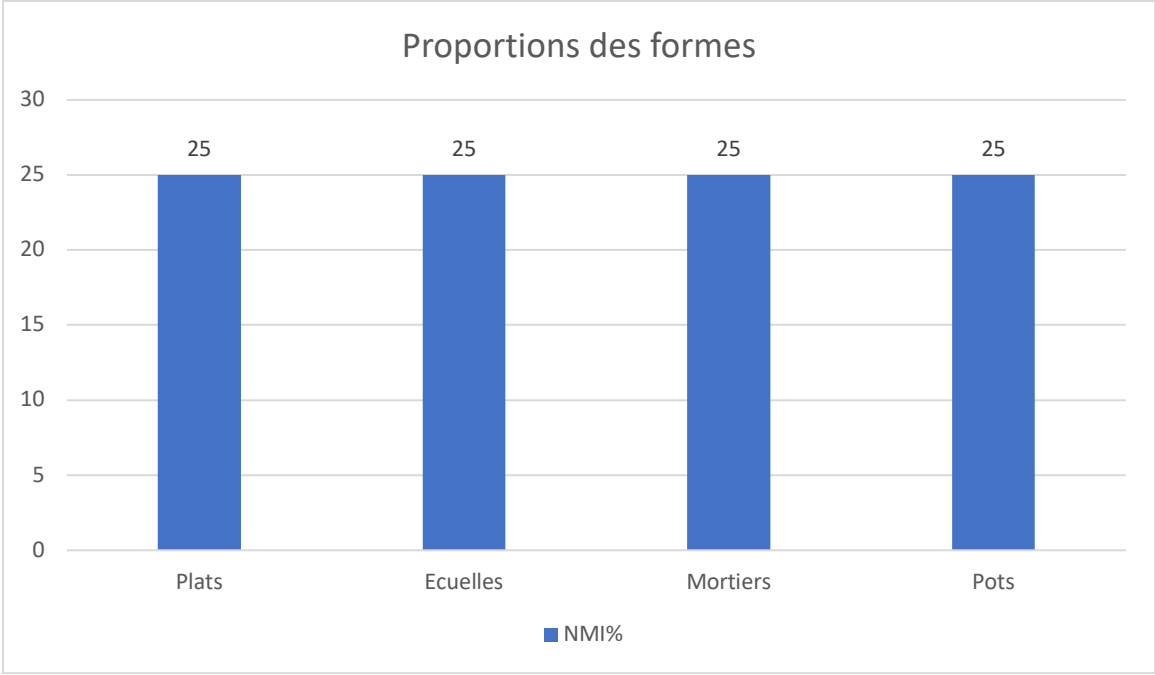


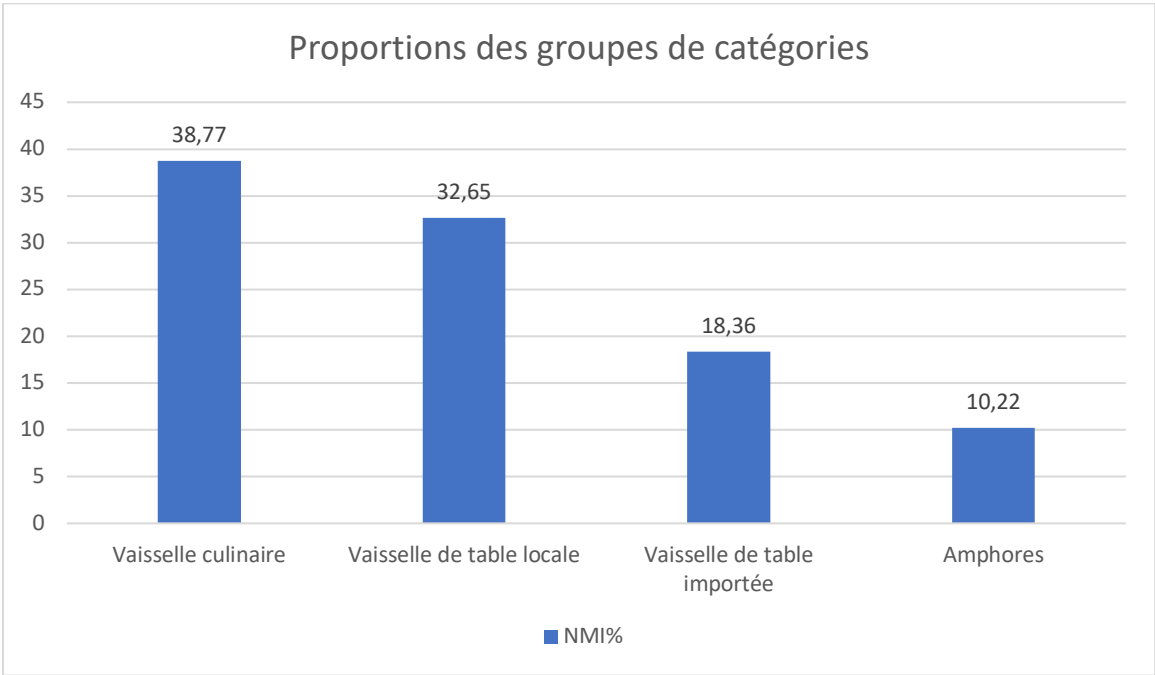
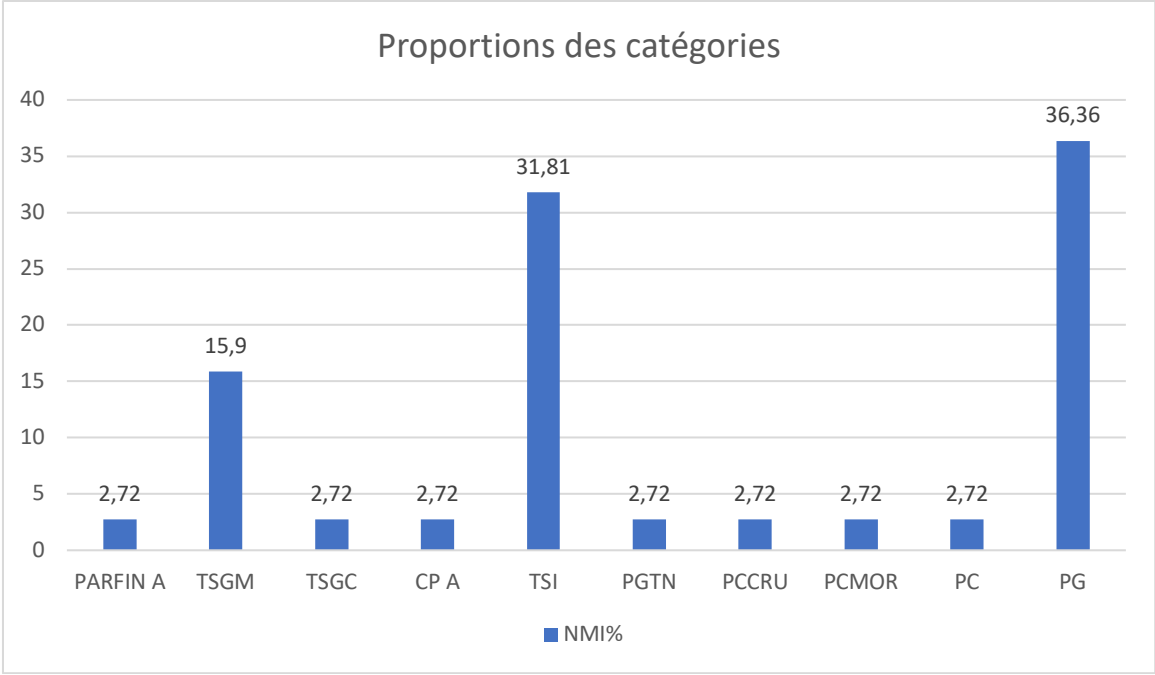
Fig. 47: Local 17b: atelier artisanal (boucherie, artisanat culinaire ?).

NMI	Catégories	%
1	PARFIN A	2,72
7	TSGM	15,9
1	TSGC	2,72
1	CP A	2,72
14	TSI	31,81
1	PGTN	2,72
1	PCCRU	2,72
1	PCMOR	2,72
1	PC	2,72
16	PG	36,36
44		100%

NMI	Catégories	%
19	Vaisselle culinaire	38,77
16	Vaisselle de table locale	32,65
9	Vaisselle de table importée	18,36
5	Amphores	10,22
49		100%

NMI	Formes	%
6	Assiettes	14,28
4	Ecuelles	9,52
2	Coupes	4,76
14	Bols	33,33
1	Mortiers	2,38
1	Gobelets	2,38
11	Pots	26,19
1	<i>Dolia</i>	2,38
1	Cruches	2,38
1	Bouilloires	2,38
42		100%

NMI	Fonctions	%
1	Consommation liquide individuel	2,17
15	Consommation solide+ semi-liquide ind.	32,8
1	Service liquide commun/stockage	2,17
10	Service solide+semi-liquide commun	21,75
1	Préparation	2,17
9	Cuisson	19,56
4	Stockage	8,69
0	Fermeture	0
5	Transport	10,87
46		100%



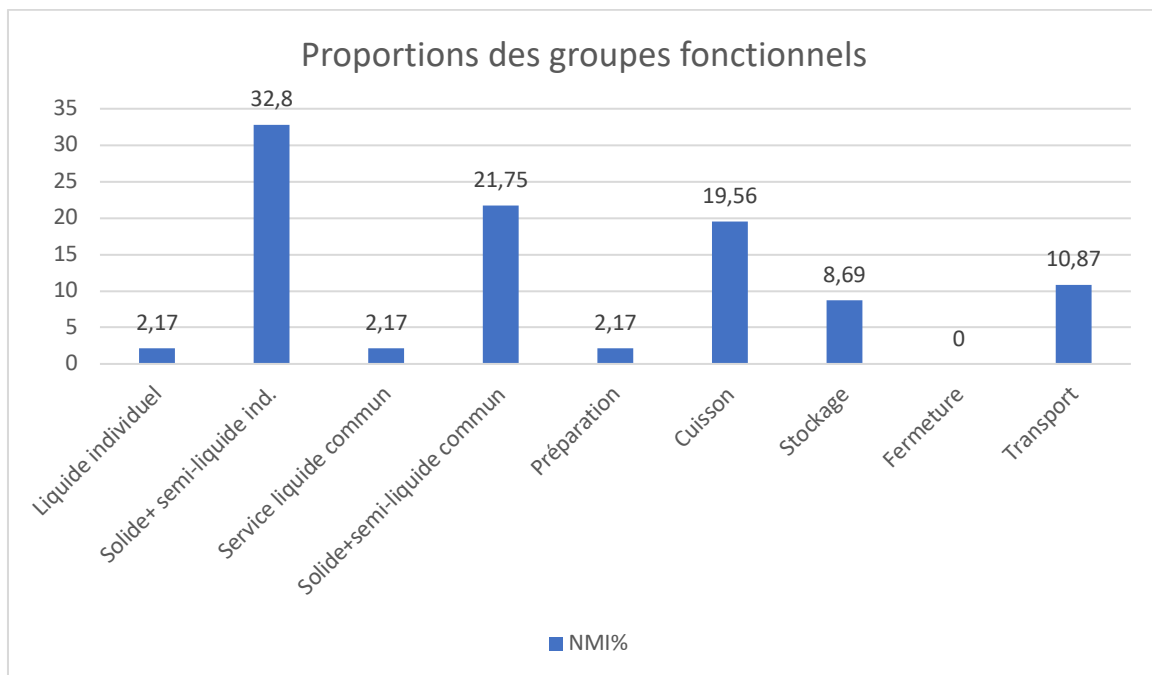
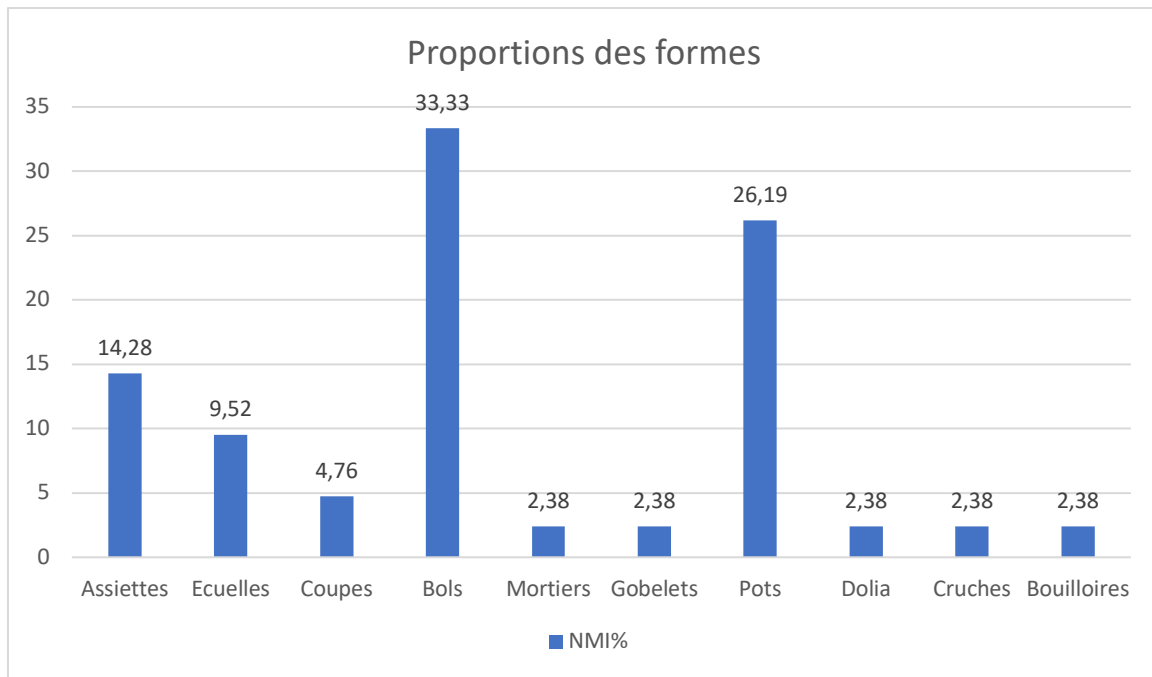


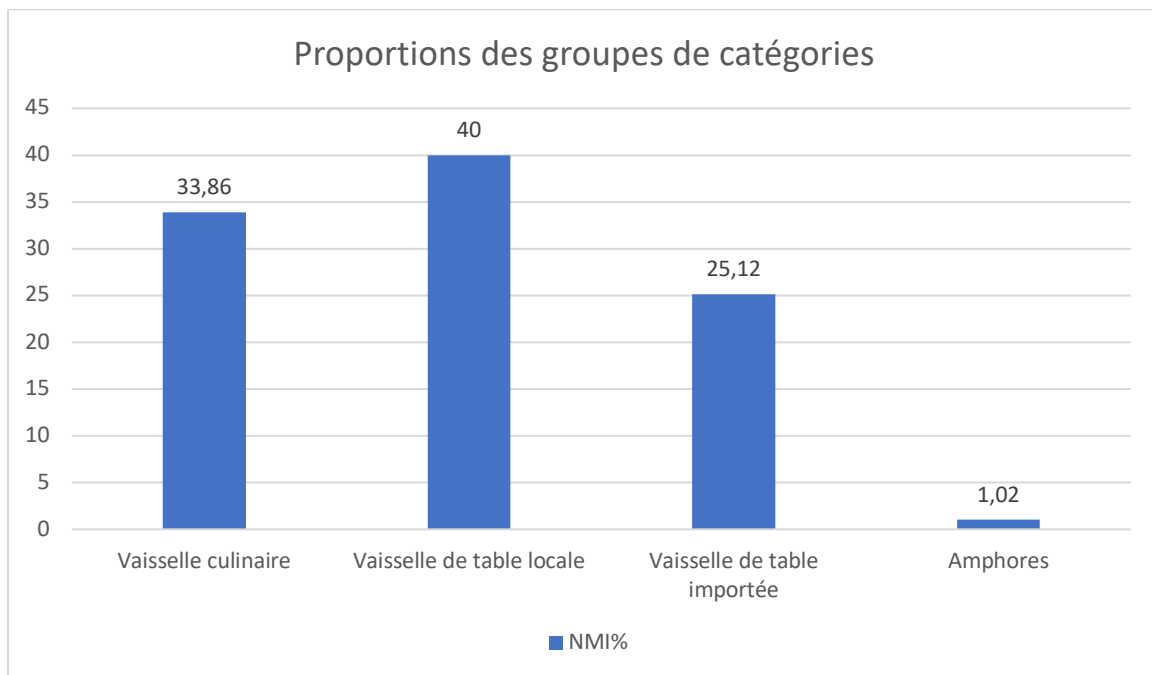
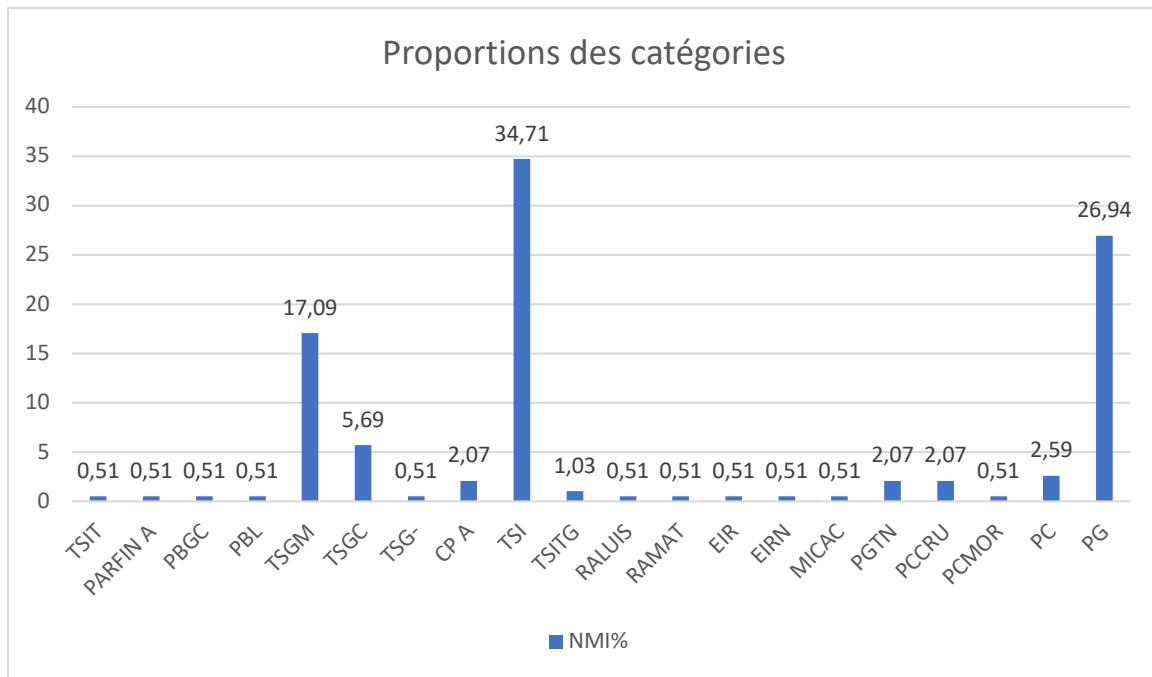
Fig. 48: Local 18: atelier artisanal (forge).

NMI	Catégories	%
1	TSIT	0,51
1	PARFIN A	0,51
1	PBGC	0,51
1	PBL	0,51
33	TSGM	17,09
11	TSGC	5,69
1	TSG-	0,51
4	CP A	2,07
67	TSI	34,71
2	TSITG	1,03
1	RALUIS	0,51
1	RAMAT	0,51
1	EIR	0,51
1	EIRN	0,51
1	MICAC	0,51
4	PGTN	2,07
4	PCCRU	2,07
1	PCMOR	0,51
5	PC	2,59
52	PG	26,94
193		100%

NMI	Catégories	%
66	Vaisselle culinaire	33,86
78	Vaisselle de table locale	40
49	Vaisselle de table importée	25,12
2	Amphores	1,02
195		100%

NMI	Formes	%
36	Assiettes	20,68
3	Plats	1,72
9	Ecuellen	5,17
2	Marmites	1,14
16	Coupes	9,19
50	Bols	28,73
1	Bols à marli	0,57
2	Bols à collerette	1,14
1	Mortiers	0,57
25	Pots	14,36
3	Tonneaux	1,72
1	Bouteilles	0,57
4	Cruches	2,29
1	Pichets	0,57
21	Couvercles	12,06
175		100%

NMI	Fonctions	%
2	Consommation liquide individuel	1,15
52	Consommation solide+ semi-liquide ind.	30,05
6	Service liquide commun/stockage	3,46
61	Service solide+semi-liquide commun	35,26
1	Préparation	0,57
14	Cuisson	8,09
14	Stockage	8,09
21	Fermeture	12,13
2	Transport	1,15
173		100%



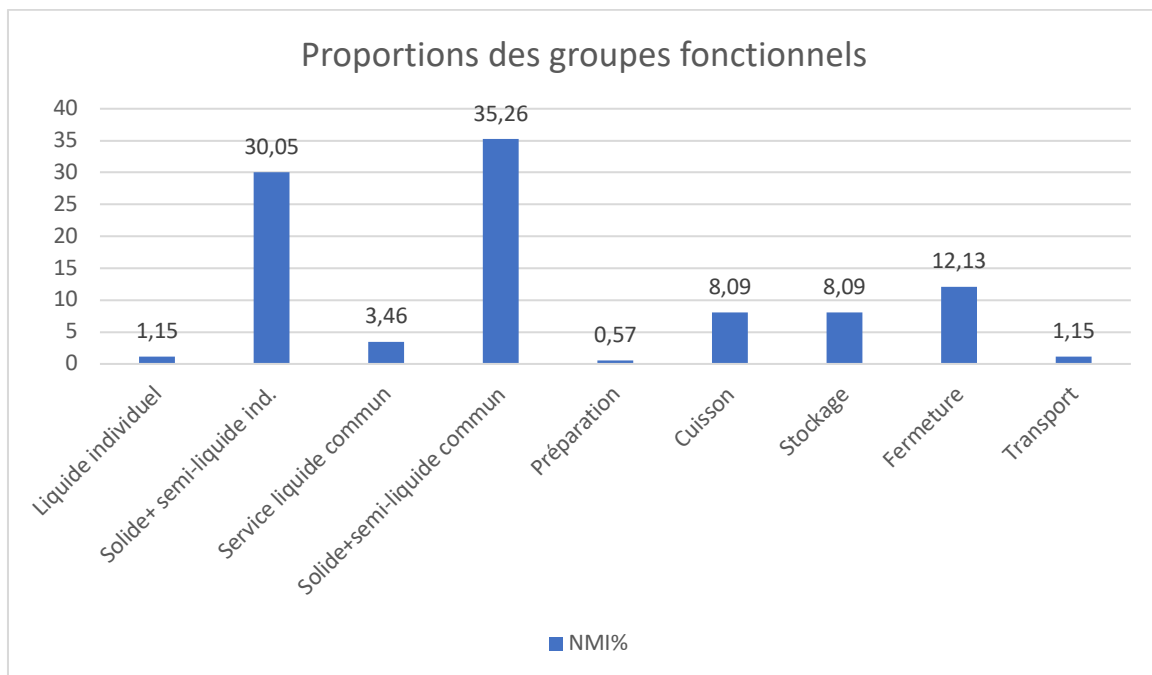
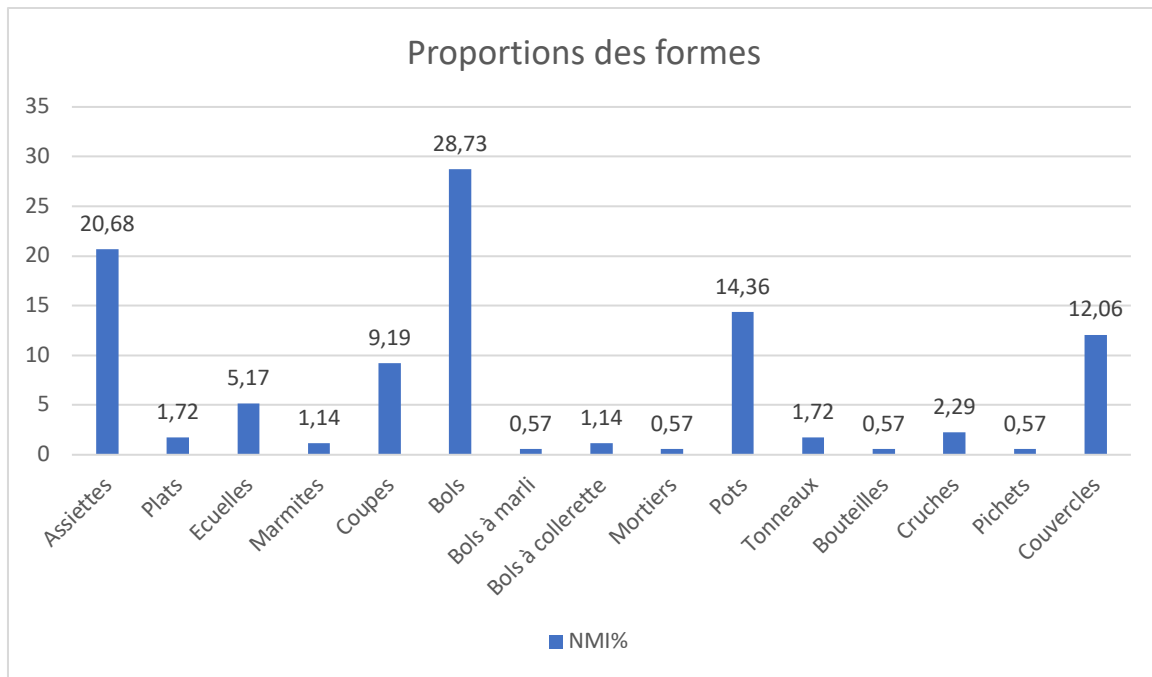


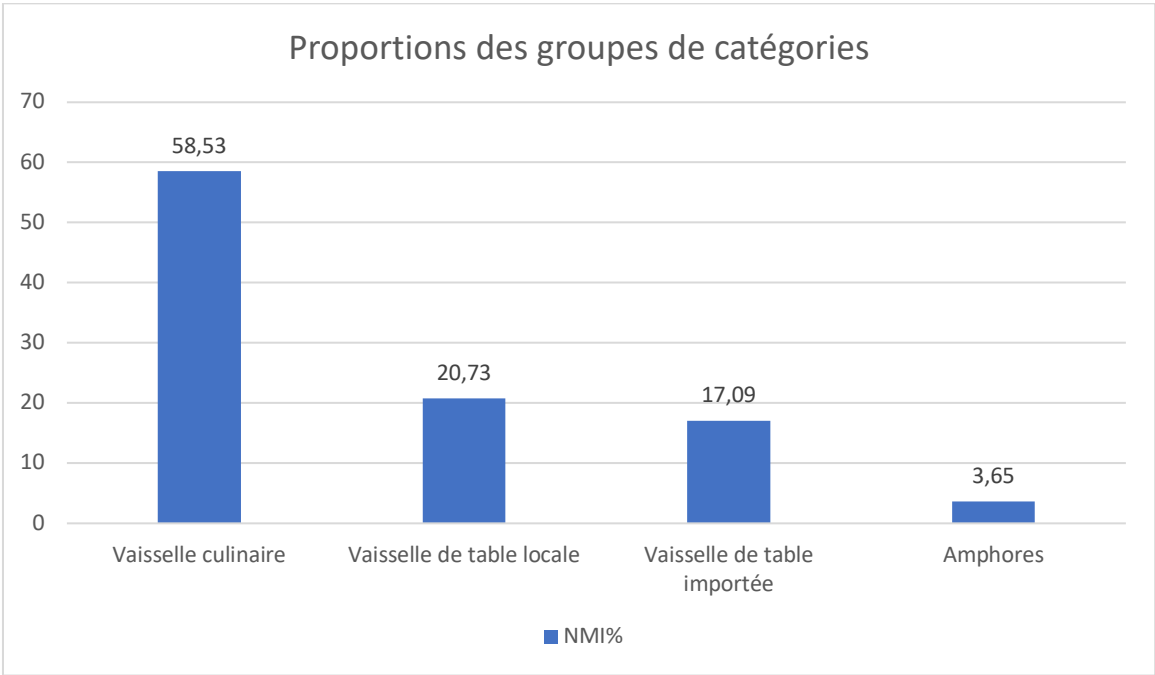
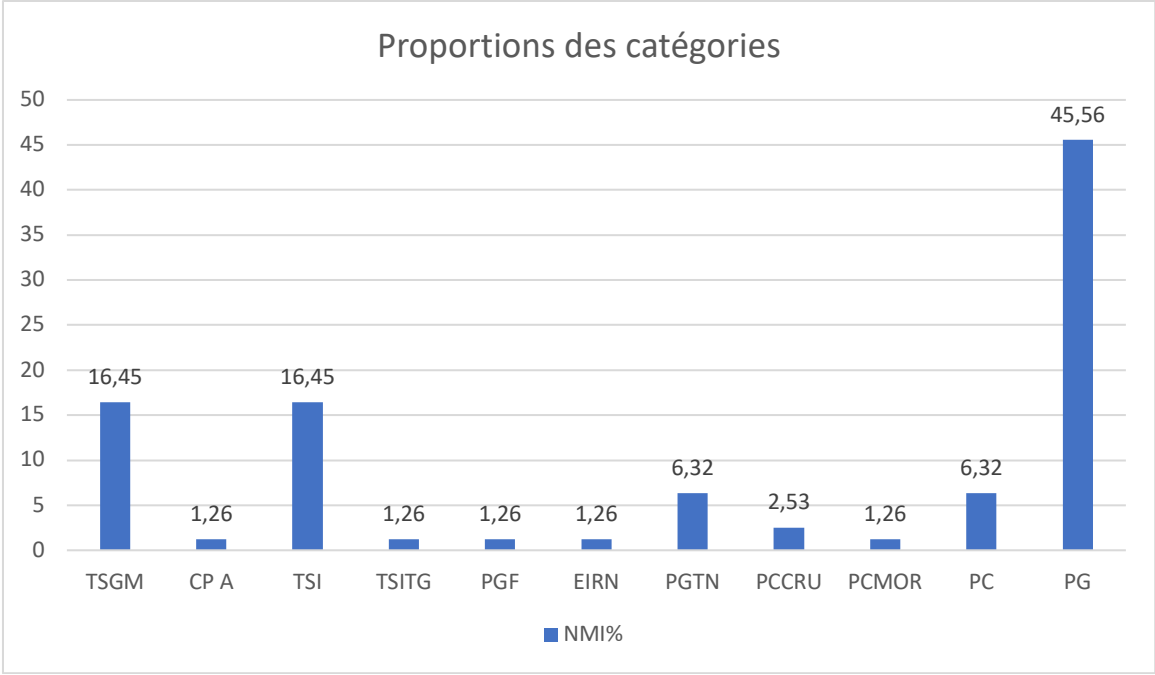
Fig. 49: Local 19: indéterminé.

NMI	Catégories	%
13	TSGM	16,45
1	CP A	1,26
13	TSI	16,45
1	TSITG	1,26
1	PGF	1,26
1	EIRN	1,26
5	PGTN	6,32
2	PCCRU	2,53
1	PCMOR	1,26
5	PC	6,32
36	PG	45,56
79		100%

NMI	Catégories	%
48	Vaisselle culinaire	58,53
17	Vaisselle de table locale	20,73
14	Vaisselle de table importée	17,09
3	Amphores	3,65
82		100%

NMI	Formes	%
10	Assiettes	12,98
2	Plats	2,59
20	Ecuelles	22,97
5	Marmites	6,49
9	Coupes	11,68
7	Bols	9,09
1	Bols à collerette	1,29
1	Mortiers	1,29
13	Pots	16,88
1	<i>Dolia</i>	1,29
1	Pichets	1,29
2	Cruches	2,59
5	Couvercles	6,49
77		100%

NMI	Fonctions	%
2	Consommation liquide individuel	2,46
25	Consommation solide+ semi-liquide ind.	30,86
3	Service liquide commun/stockage	3,7
20	Service solide+semi-liquide commun	24,69
2	Préparation	2,46
7	Cuisson	8,64
14	Stockage	17,28
5	Fermeture	6,17
3	Transport	3,7
81		100%



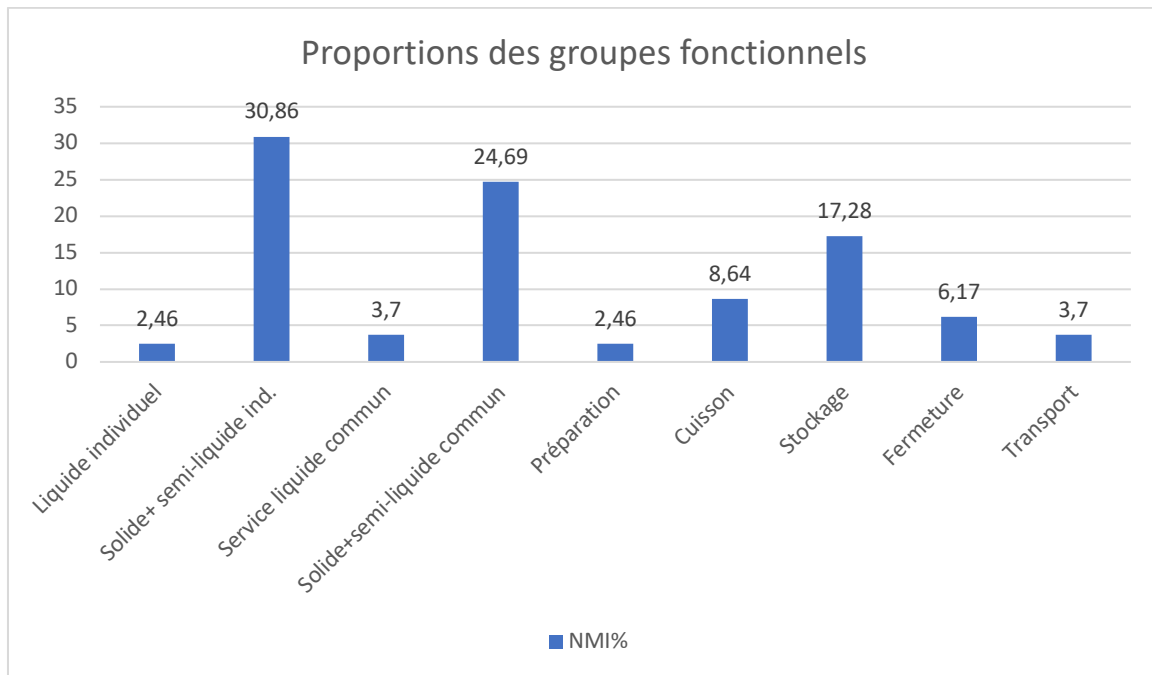
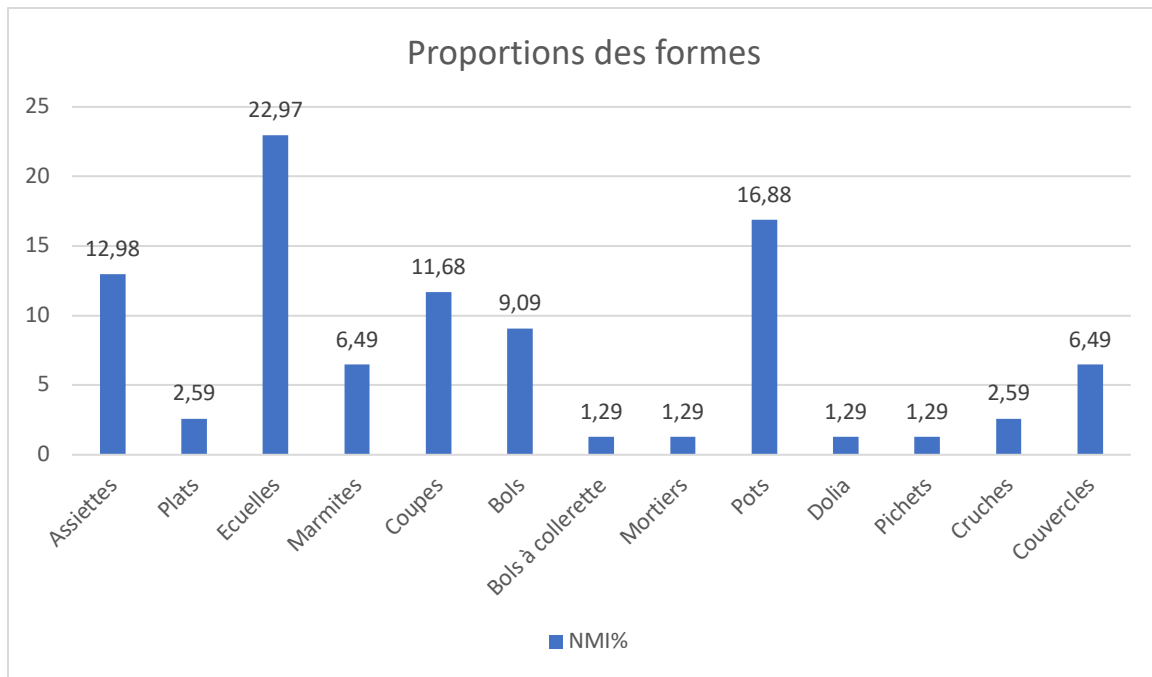


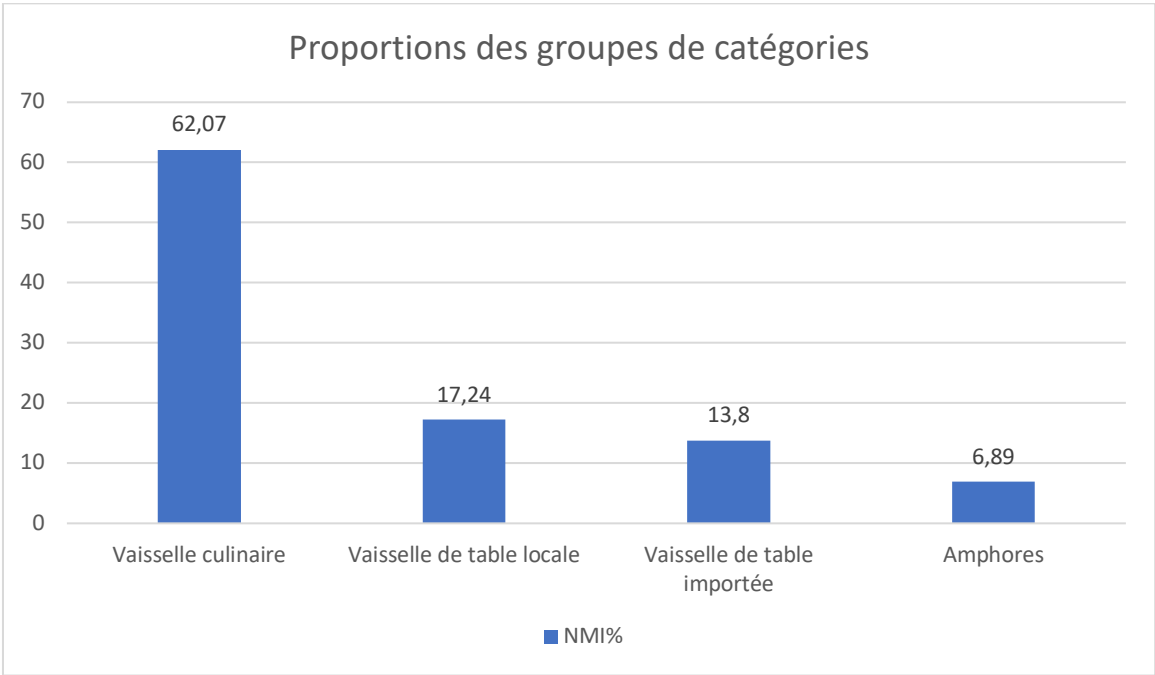
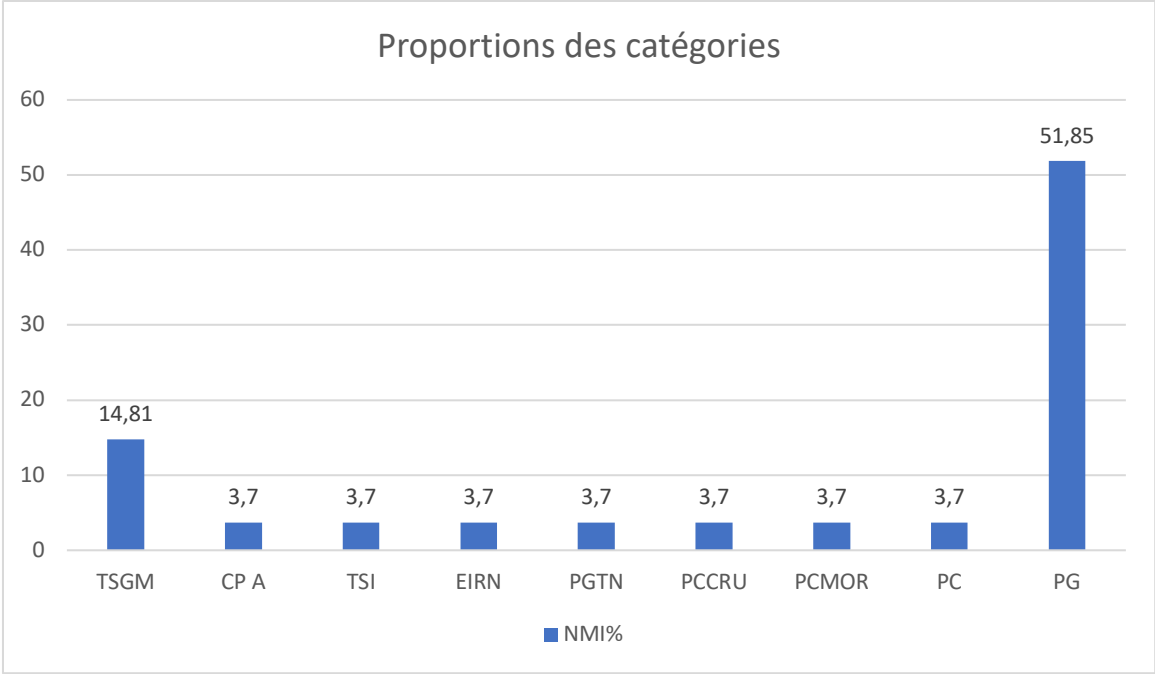
Fig. 50: Local 20: indéterminé (cuisine ?).

NMI	Catégories	%
4	TSGM	14,81
1	CP A	3,7
1	TSI	3,7
1	EIRN	3,7
1	PGTN	3,7
3	PCCRU	3,7
1	PCMOR	3,7
1	PC	3,7
14	PG	51,85
27		100%

NMI	Catégories	%
18	Vaisselle culinaire	62,07
5	Vaisselle de table locale	17,24
4	Vaisselle de table importée	13,8
2	Amphores	6,89
29		100%

NMI	Formes	%
2	Assiettes	8,33
1	Plats	4,16
5	Ecuelles	20,83
4	Marmites	16,66
1	Coupes	4,16
2	Bols	8,33
1	Mortiers	4,16
4	Pots	16,66
3	Cruches	12,55
1	Couvercles	4,16
24		100%

NMI	Fonctions	%
0	Consommation liquide individuel	0
6	Consommation solide+ semi-liquide ind.	23,07
3	Service liquide commun/stockage	11,53
4	Service solide+semi-liquide commun	15,38
1	Préparation	3,84
8	Cuisson	30,76
1	Stockage	3,84
1	Fermeture	3,84
2	Transport	7,69
26		100%



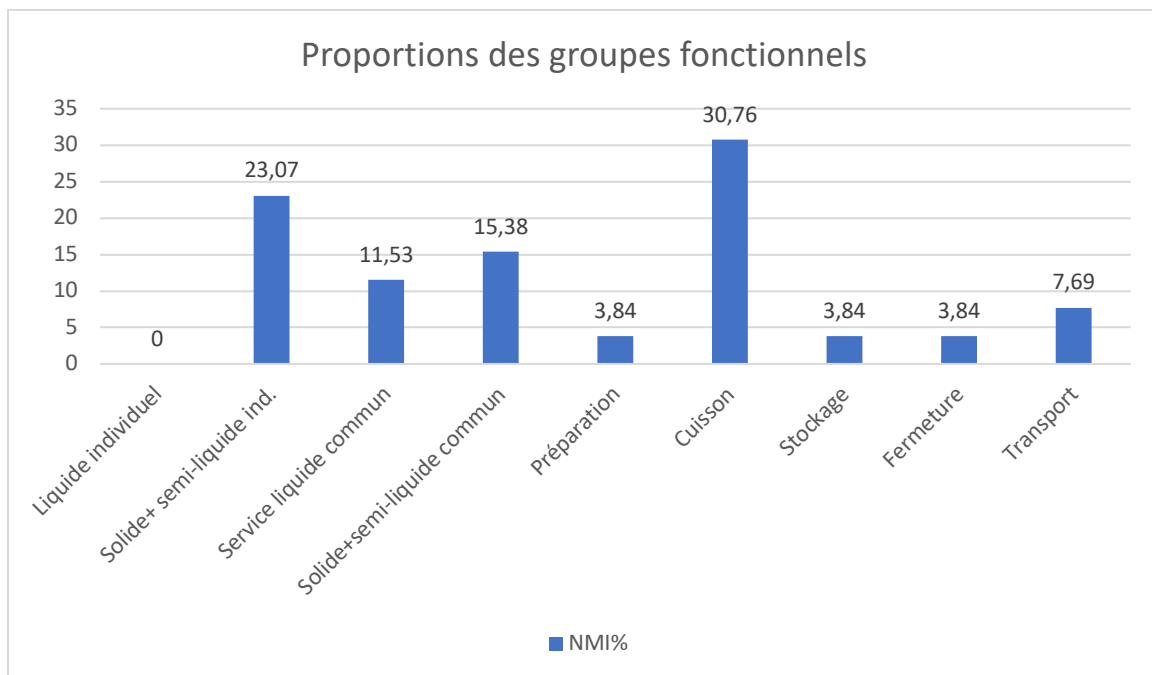
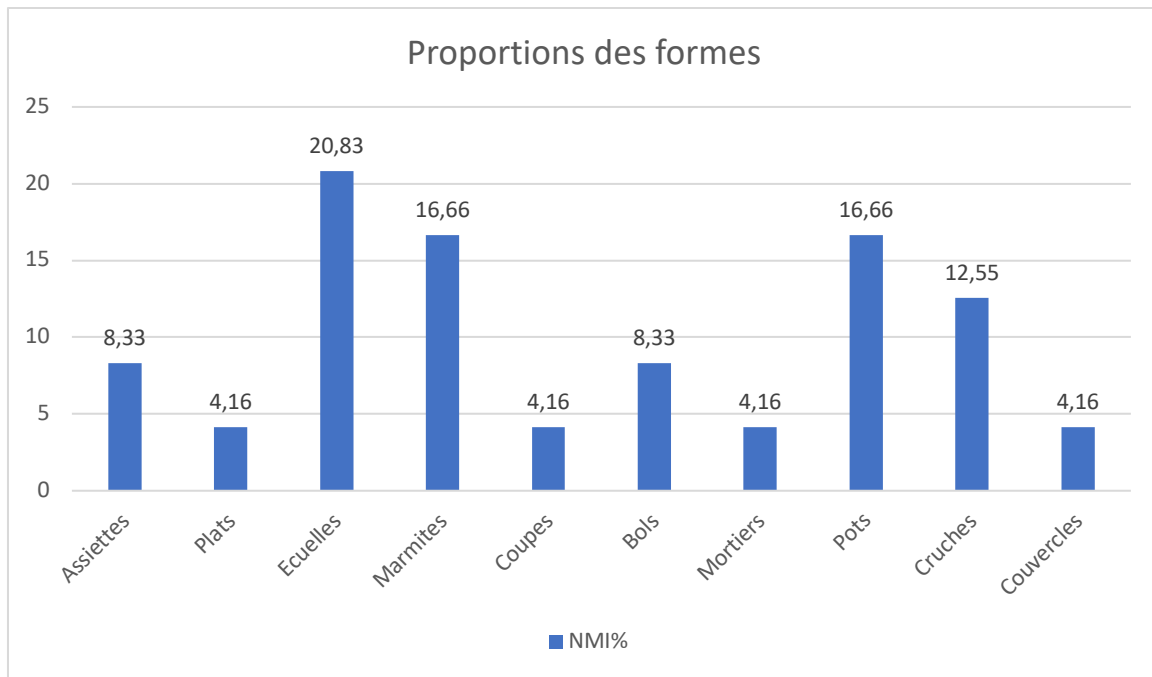


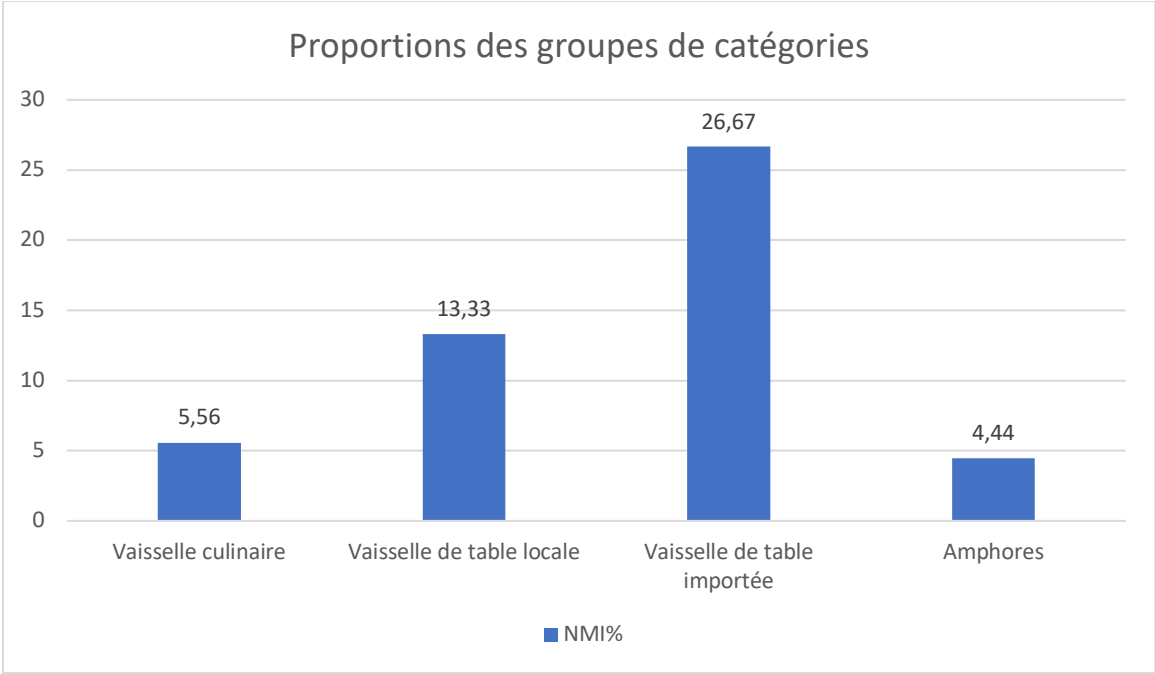
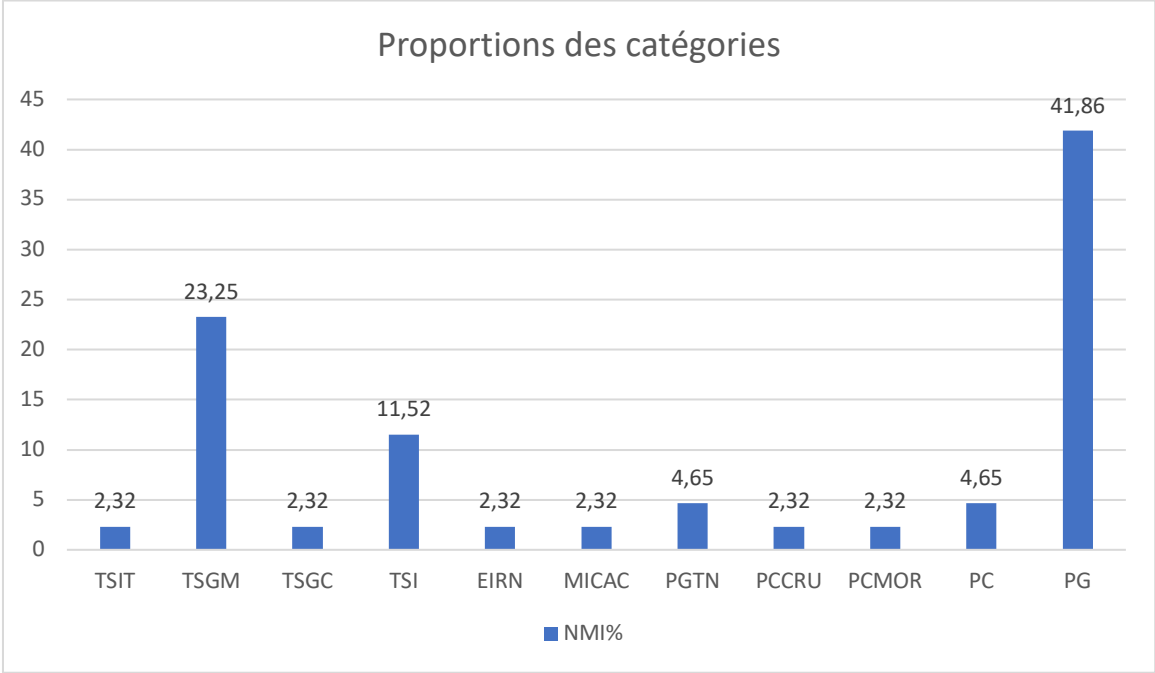
Fig. 51: Local 21: échoppe/commerce alimentaire.

NMI	Catégories	%
1	TSIT	2,32
10	TSGM	23,25
1	TSGC	2,32
5	TSI	11,52
1	EIRN	2,32
1	MICAC	2,32
2	PGTN	4,65
1	PCCRU	2,32
1	PCMOR	2,32
2	PC	4,65
18	PG	41,86
43		100%

NMI	Catégories	%
25	Vaisselle culinaire	5,56
6	Vaisselle de table locale	13,33
12	Vaisselle de table importée	26,67
2	Amphores	4,44
45		100%

NMI	Formes	%
9	Assiettes	21,42
1	Plats	2,38
6	Ecuelles	14,28
2	Marmites	4,76
2	Coupes	4,76
5	Bols	11,9
1	Mortiers	2,38
9	Pots	21,42
1	Pots à provision	2,38
1	Tonneaux	2,38
1	Cruches	2,38
4	Couvercles	9,52
42		100%

NMI	Fonctions	%
0	Consommation liquide individuel	0
9	Consommation solide+ semi-liquide ind.	20,45
2	Service liquide commun/stockage	4,54
13	Service solide+semi-liquide commun	29,54
1	Préparation	2,27
9	Cuisson	20,45
4	Stockage	9,09
4	Fermeture	9,09
2	Transport	4,54
44		100%



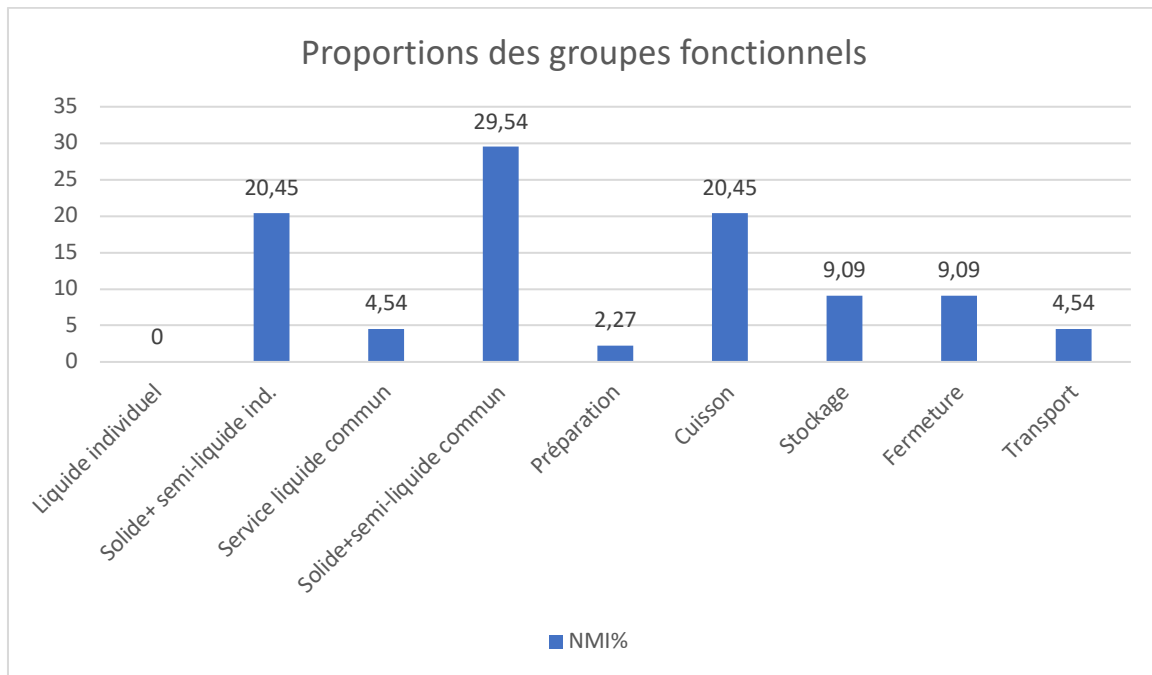
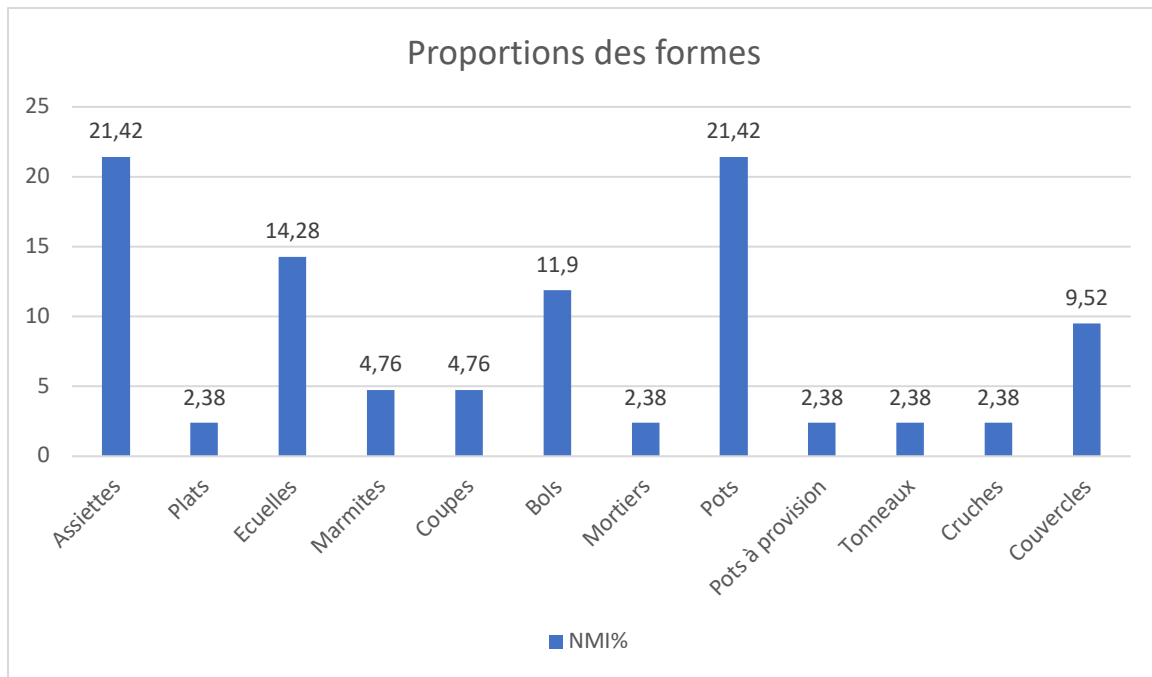


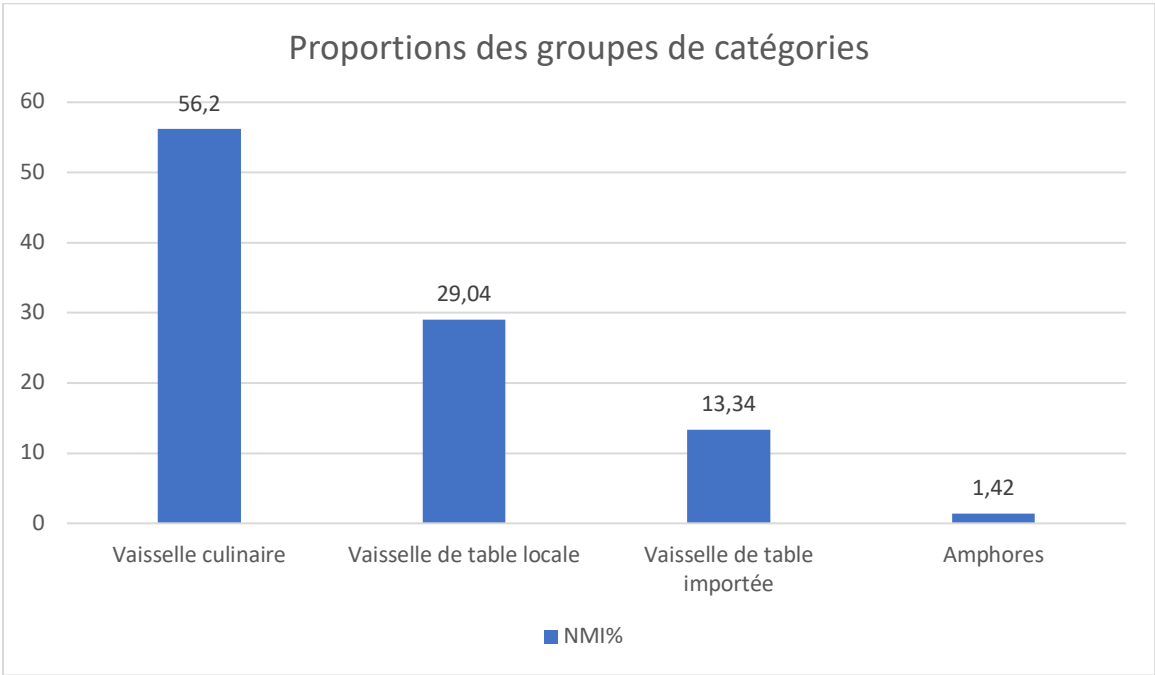
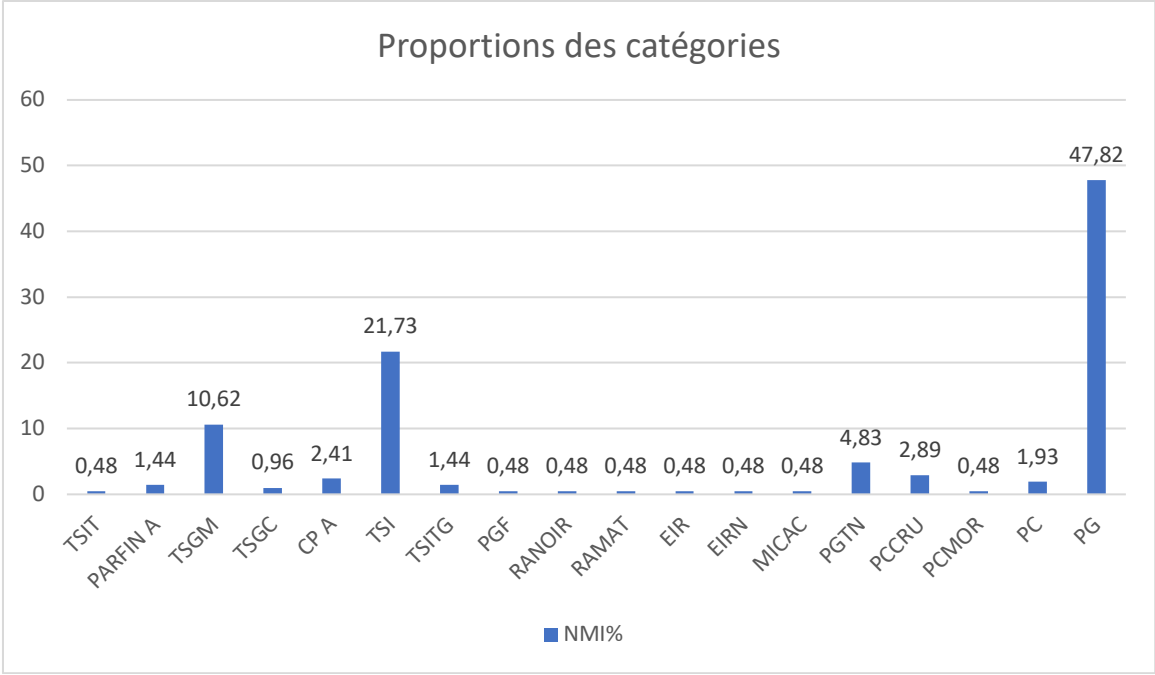
Fig. 52: Local 22: cour.

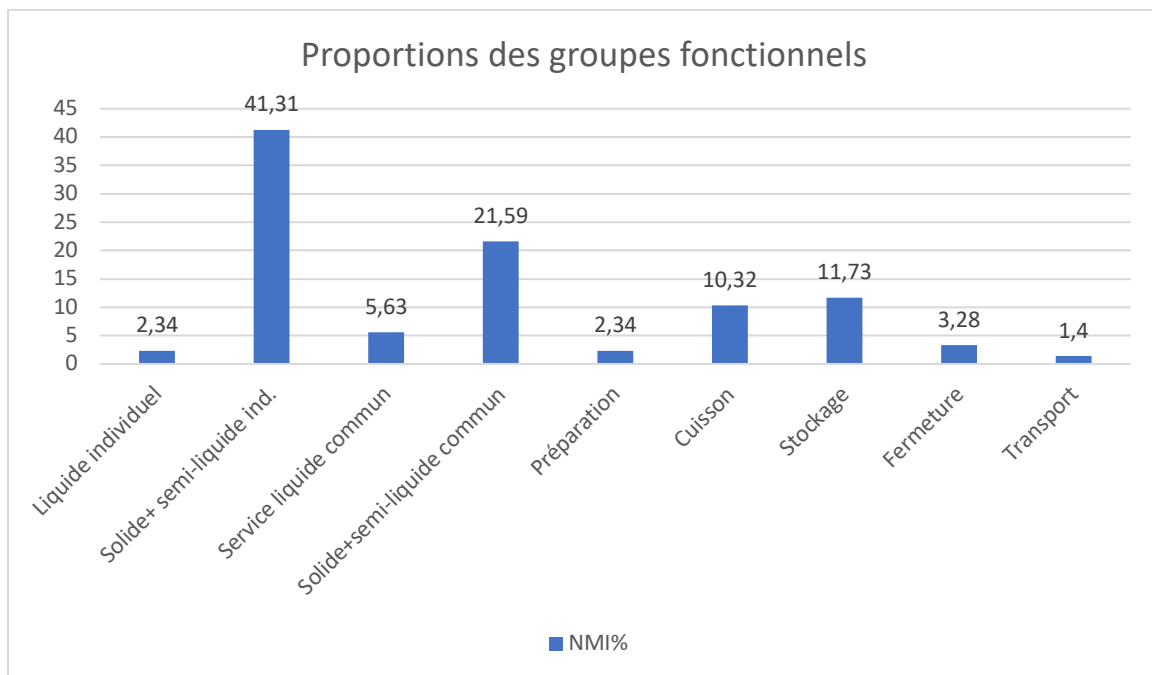
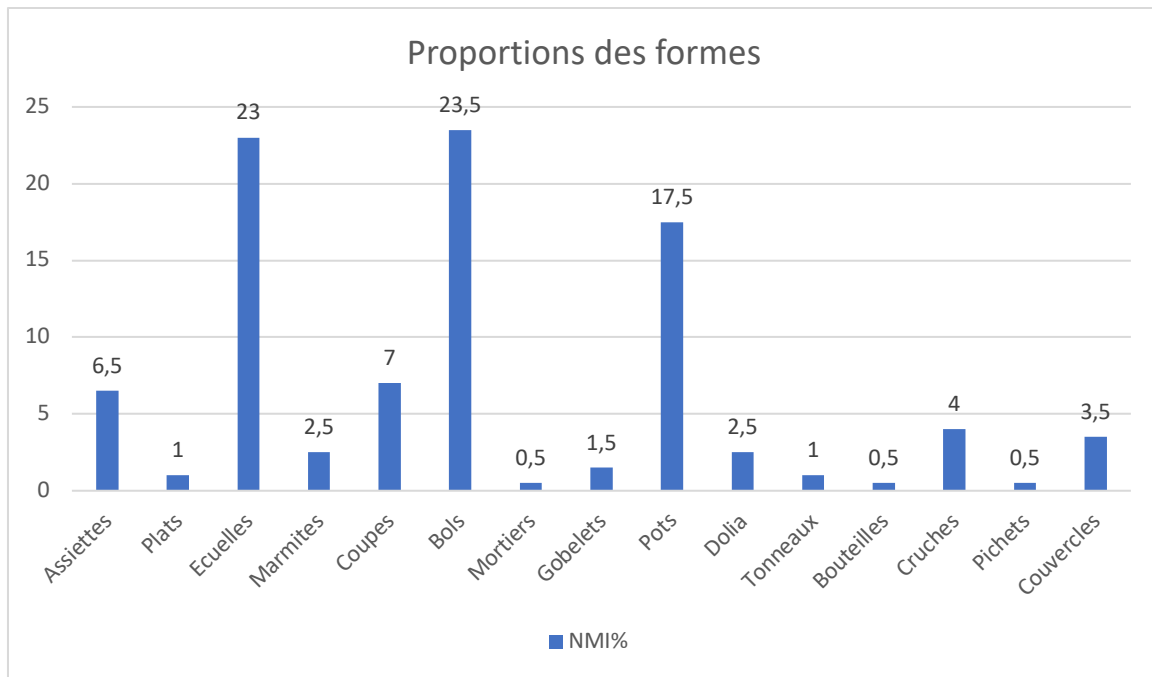
NMI	Catégories	%
1	TSIT	0,48
3	PARFIN A	1,44
22	TSGM	10,62
2	TSGC	0,96
5	CP A	2,41
45	TSI	21,73
3	TSITG	1,44
1	PGF	0,48
1	RANOIR	0,48
1	RAMAT	0,48
1	EIR	0,48
1	EIRN	0,48
1	MICAC	0,48
10	PGTN	4,83
6	PCCRU	2,89
1	PCMOR	0,48
4	PC	1,93
99	PG	47,82
207		100%

NMI	Catégories	%
118	Vaisselle culinaire	56,2
61	Vaisselle de table locale	29,04
28	Vaisselle de table importée	13,34
3	Amphores	1,42
210		100%

NMI	Formes	%
23	Assiettes	6,5
2	Plats	1
46	Ecuelles	23
5	Marmites	2,5
14	Coupes	7
47	Bols	23,5
1	Mortiers	0,5
3	Gobelets	1,5
35	Pots	17,5
5	<i>Dolia</i>	2,5
2	Tonneaux	1
1	Bouteilles	0,5
8	Cruches	4
1	Pichets	0,5
7	Couvercles	3,5
200		100%

NMI	Fonctions	%
5	Consommation liquide individuel	2,34
88	Consommation solide+ semi-liquide ind.	41,31
12	Service liquide commun/stockage	5,63
46	Service solide+semi-liquide commun	21,59
5	Préparation	2,34
22	Cuisson	10,32
25	Stockage	11,73
7	Fermeture	3,28
3	Transport	1,4
213		100%





4.2.4. Période C-1 (180 ap. J.-C.)

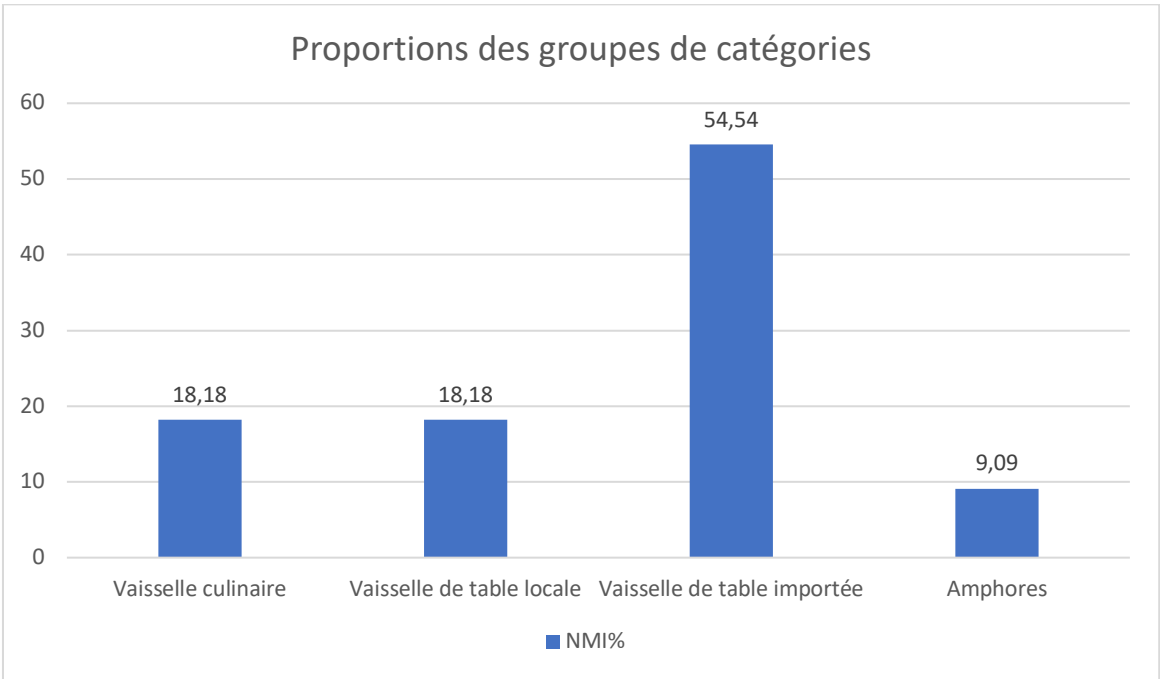
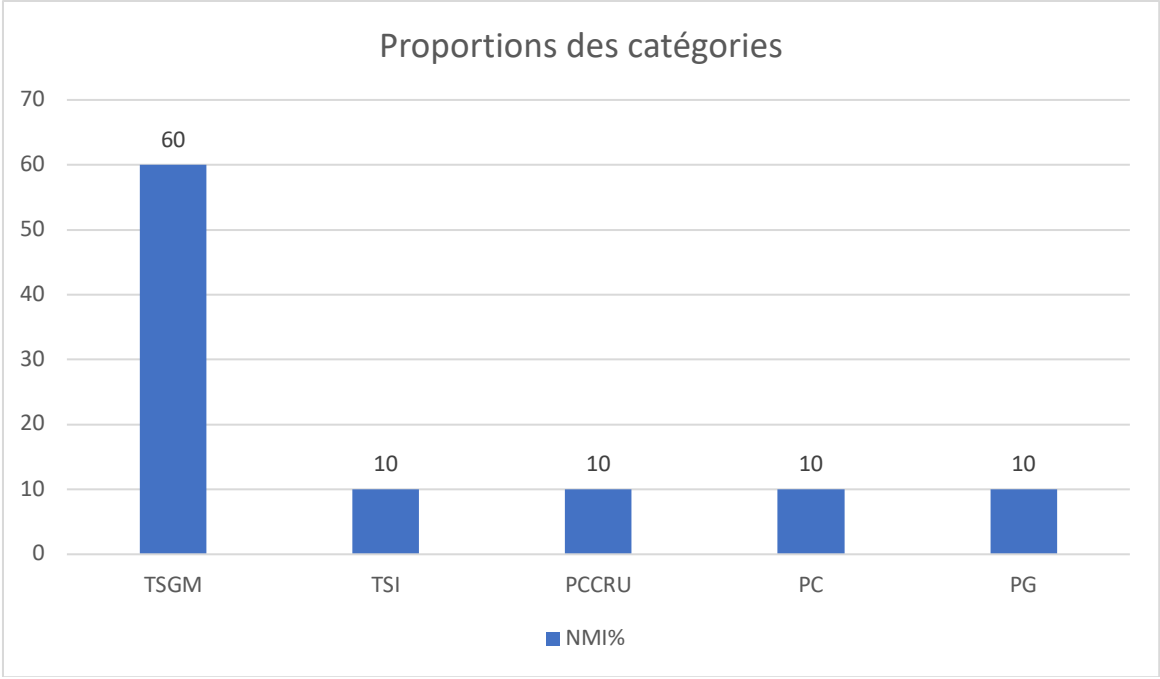
Fig. 54: Local 3: stockage ?

NMI	Catégories	%
6	TSGM	60
1	TSI	10
1	PCCRU	10
1	PC	10
1	PG	10
10		100%

NMI	Catégories	%
2	Vaisselle culinaire	18,18
2	Vaisselle de table locale	18,18
6	Vaisselle de table importée	54,54
1	Amphores	9,09
11		100%

NMI	Formes	%
2	Assiettes	22,22
1	Ecuelles	11,11
3	Coupes	33,33
2	Bols	22,22
1	Cruches	11,11
9		100%

NMI	Fonctions	%
3	Consommation liquide individuel	30
2	Consommation solide+ semi-liquide ind.	20
1	Service liquide commun/stockage	10
3	Service solide+semi-liquide commun	30
0	Préparation	0
0	Cuisson	0
0	Stockage	0
0	Fermeture	0
1	Transport	10
10		100%



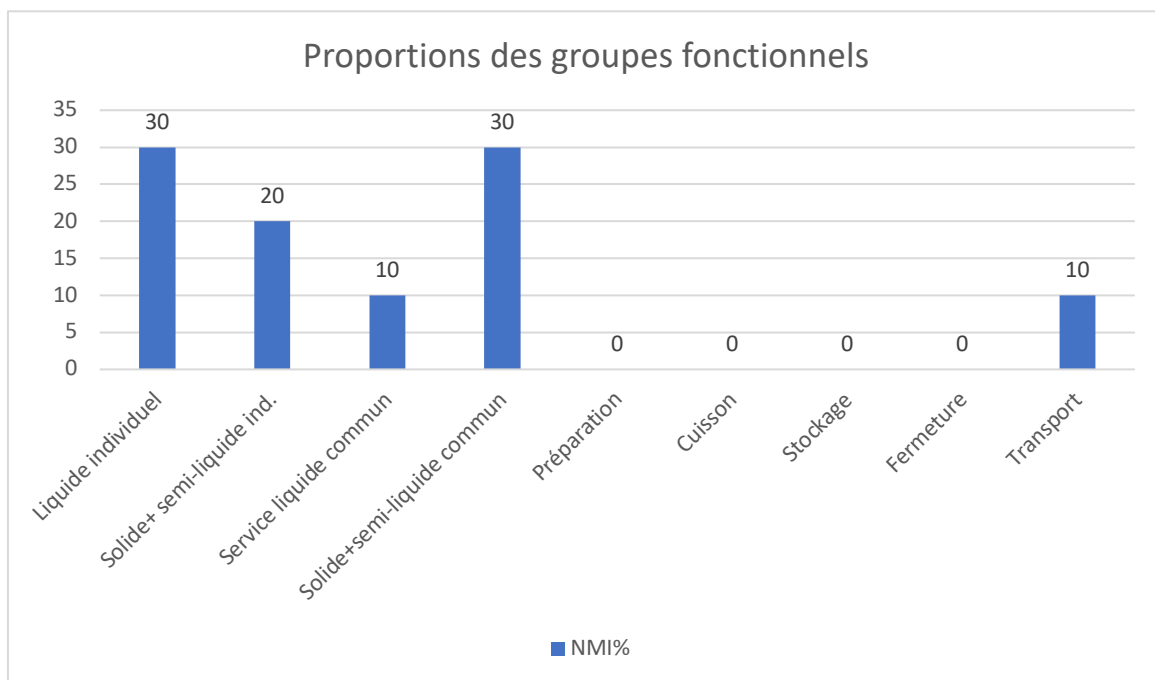
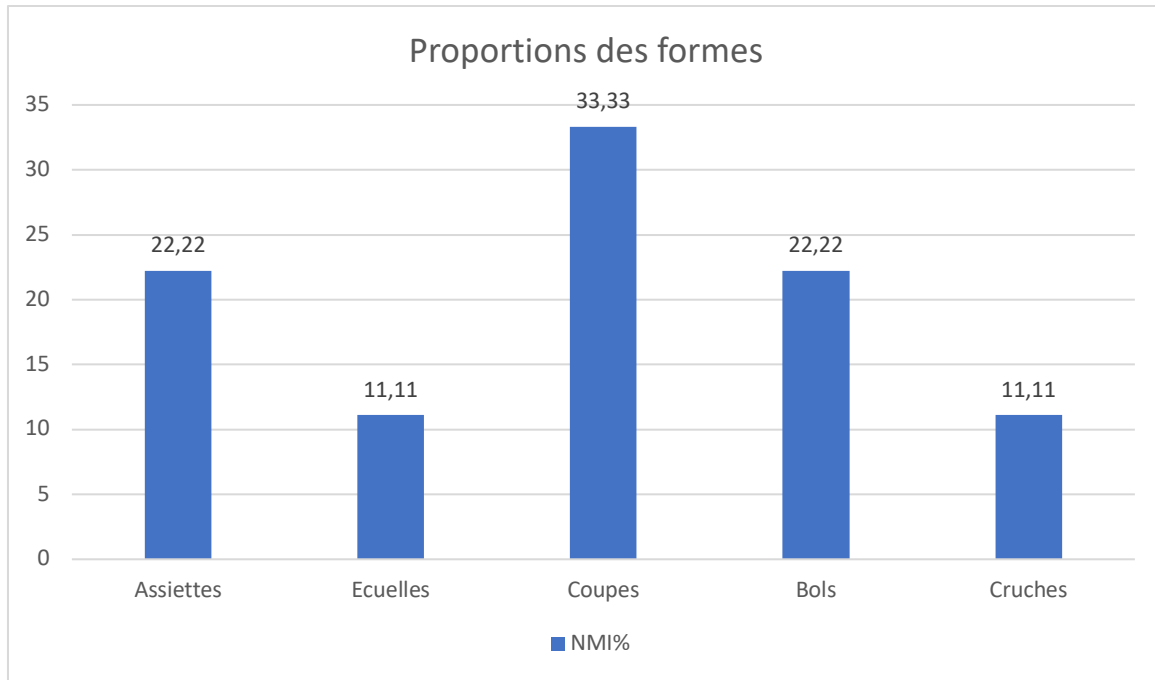


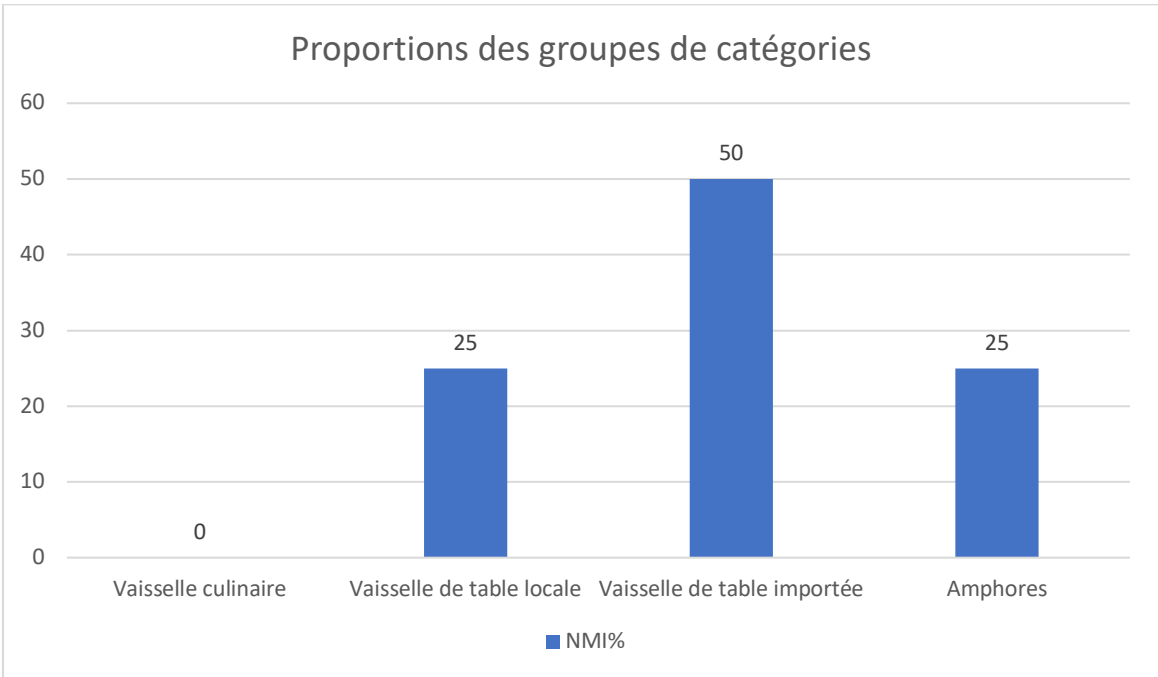
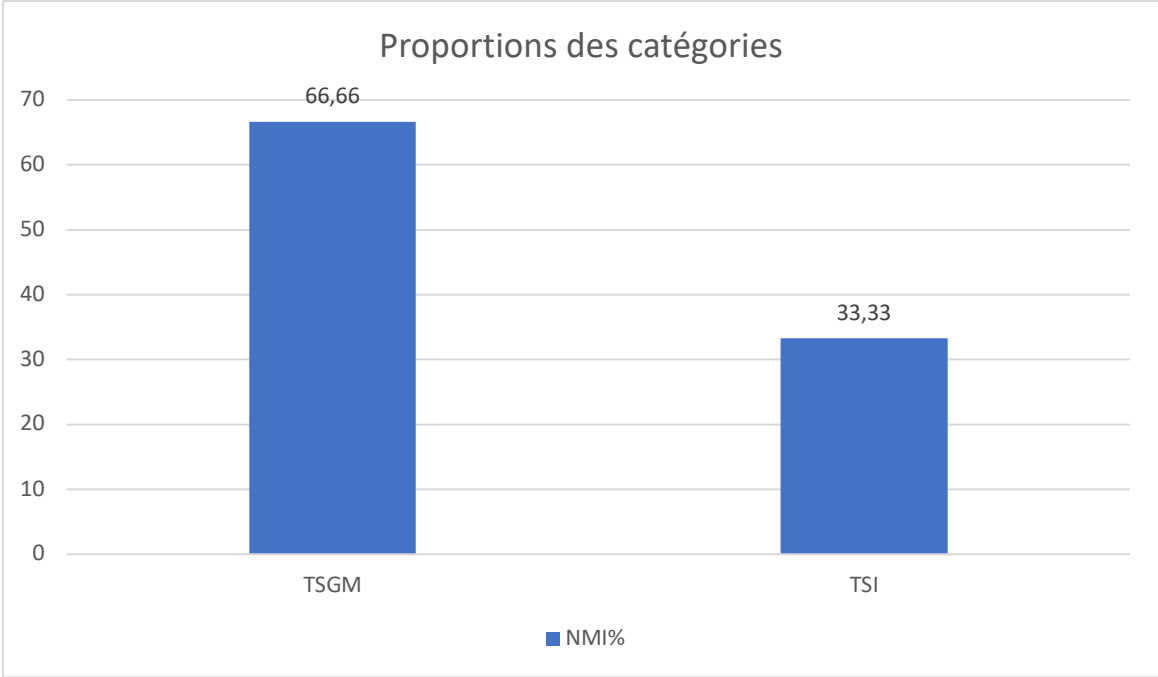
Fig. 55: Local 5: indéterminé.

NMI	Catégories	%
2	TSGM	66,66
1	TSI	33,33
3		100%

NMI	Catégories	%
0	Vaisselle culinaire	0
1	Vaisselle de table locale	25
2	Vaisselle de table importée	50
1	Amphores	25
4		100%

NMI	Formes	%
1	Assiettes	50
1	Bols	50
2		100%

NMI	Fonctions	%
0	Consommation liquide individuel	0
0	Consommation solide+ semi-liquide ind.	0
0	Service liquide commun/stockage	0
2	Service solide+semi-liquide commun	66,66
0	Préparation	0
0	Cuisson	0
0	Stockage	0
0	Fermeture	0
1	Transport	33,33
3		100%



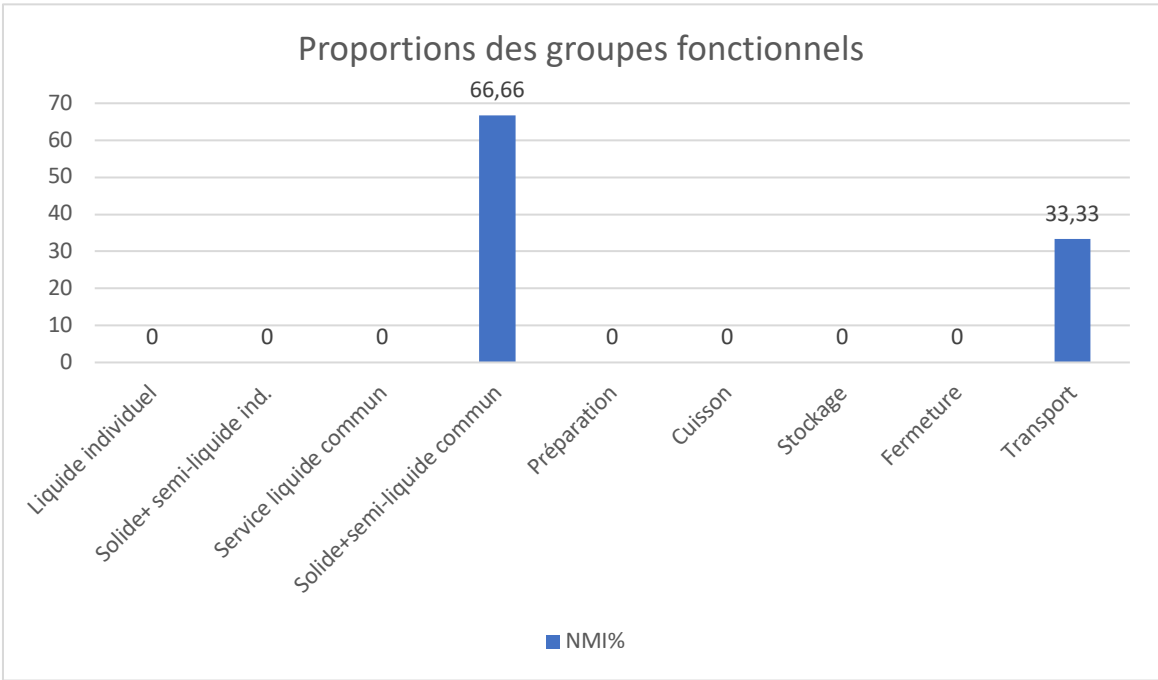
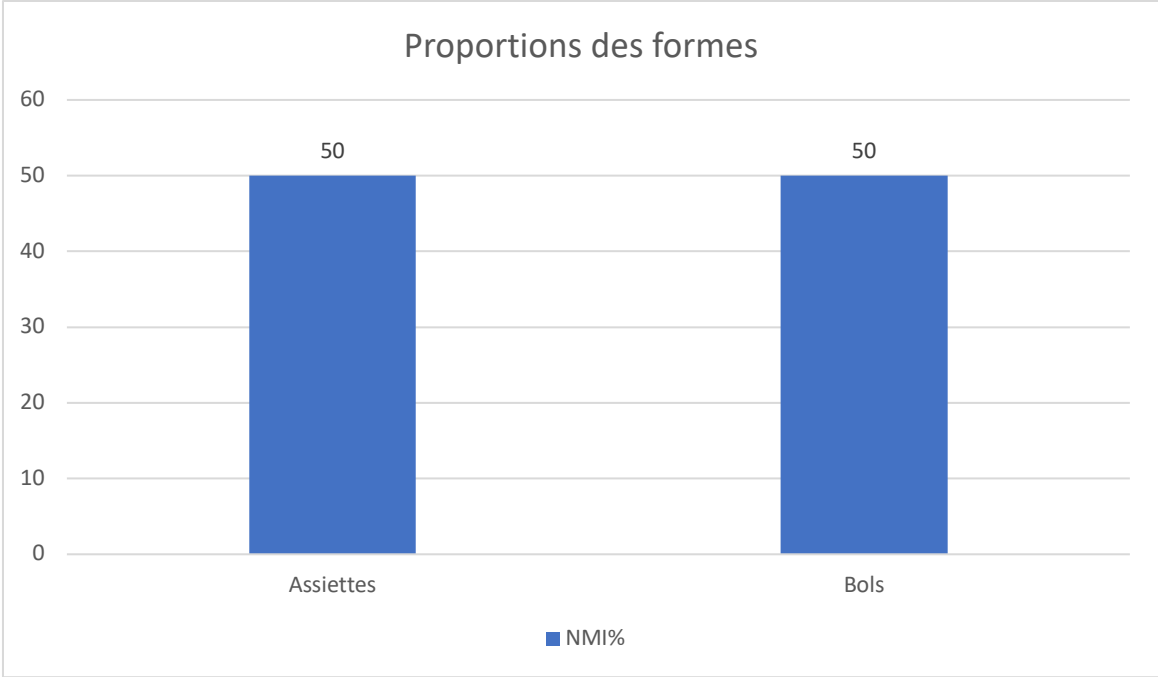


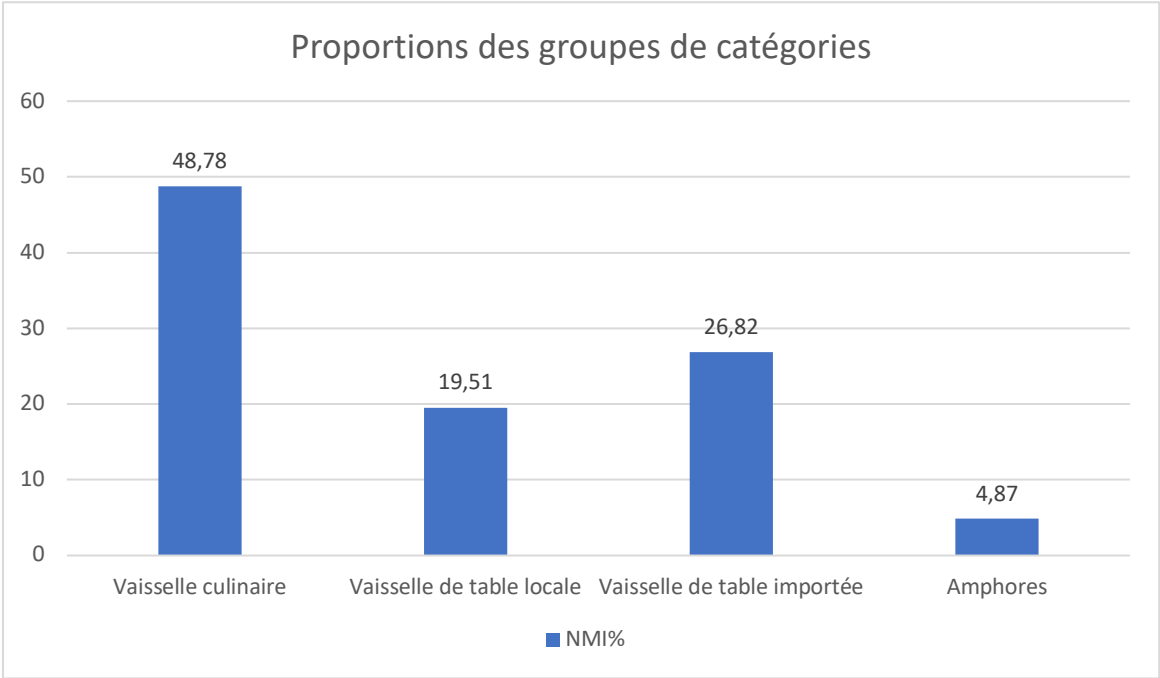
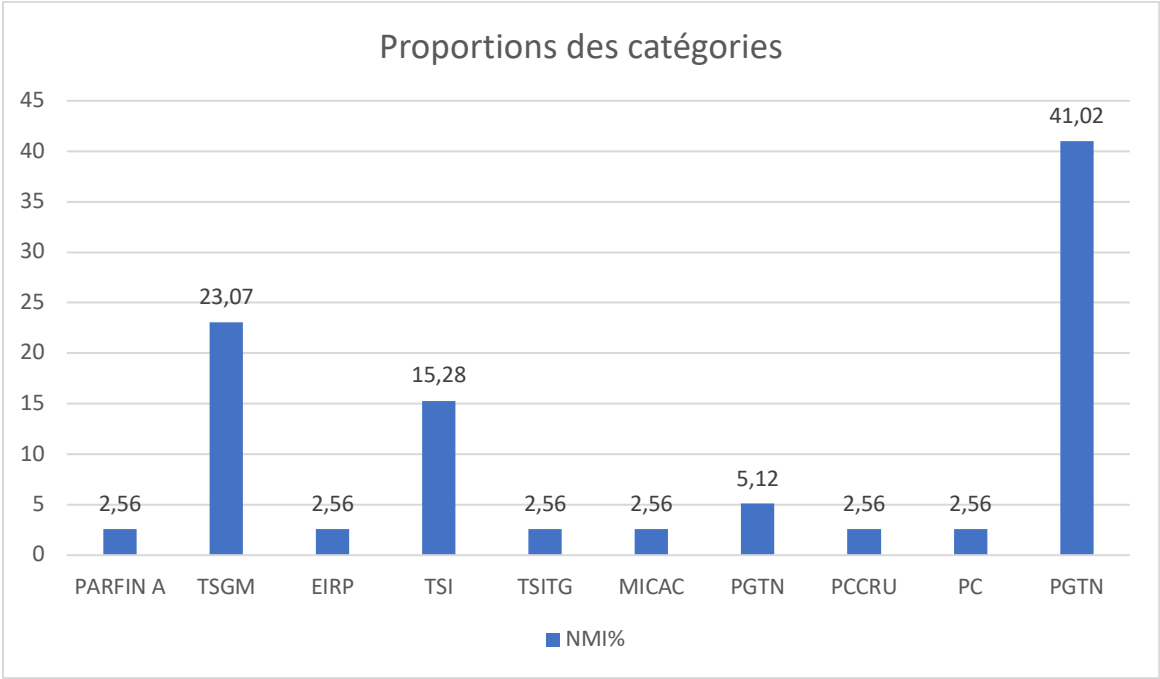
Fig. 56: Local 12 : cuisine ?

NMI	Catégories	%
1	PARFIN A	2,56
9	TSGM	23,07
1	EIRP	2,56
6	TSI	15,28
1	TSITG	2,56
1	MICAC	2,56
2	PGTN	5,12
1	PCCRU	2,56
1	PC	2,56
16	PGTN	41,02
39		100%

NMI	Catégories	%
20	Vaisselle culinaire	48,78
8	Vaisselle de table locale	19,51
11	Vaisselle de table importée	26,82
2	Amphores	4,87
41		100%

NMI	Formes	%
7	Assiettes	18,91
1	Plats	2,7
6	Ecuelles	16,21
5	Coupes	13,51
4	Bols	10,81
1	Gobelets	2,7
8	Pots	21,62
1	<i>Dolia</i>	2,7
1	Tonneaux	2,7
1	Cruches	2,7
2	Couvercles	5,4
37		100%

NMI	Fonctions	%
2	Consommation liquide individuel	5,55
9	Consommation solide+ semi-liquide ind.	25,04
2	Service liquide commun/stockage	5,55
10	Service solide+semi-liquide commun	27,77
0	Préparation	0
3	Cuisson	8,33
6	Stockage	16,66
2	Fermeture	5,55
2	Transport	5,55
36		100%



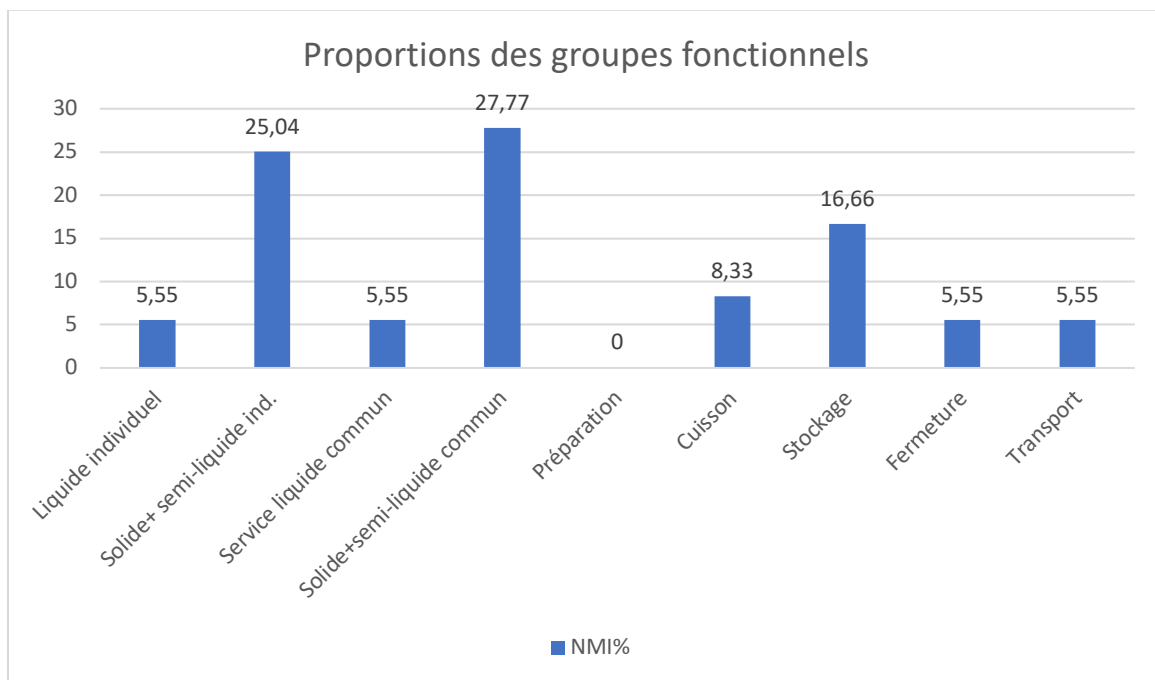
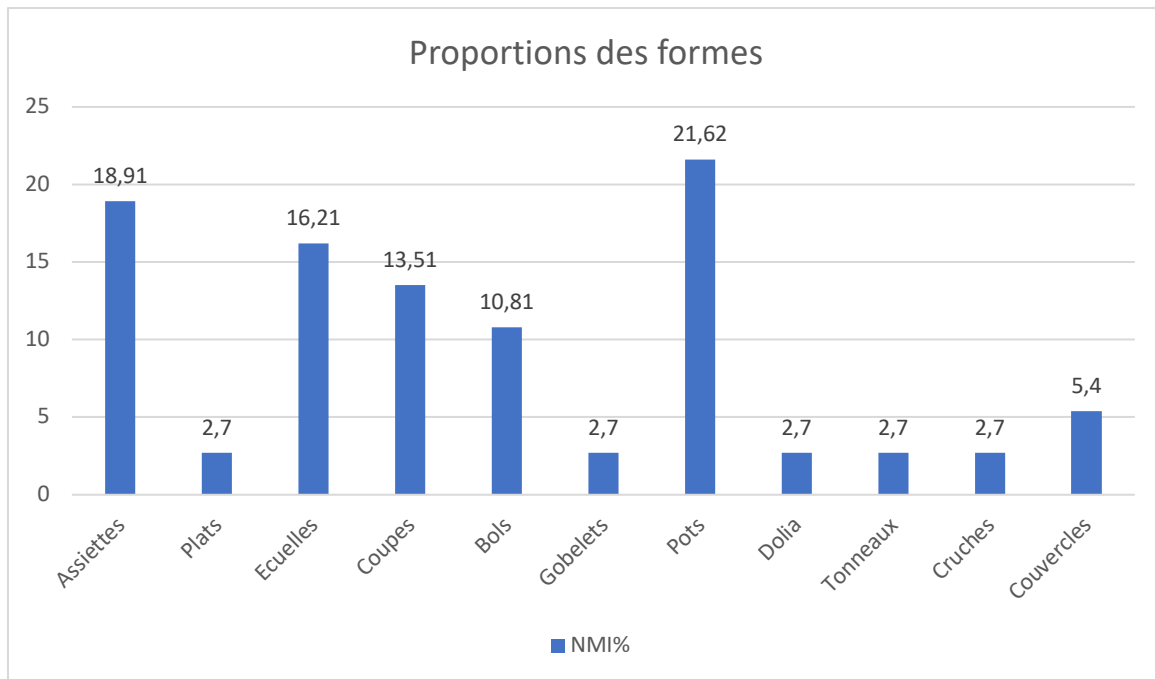


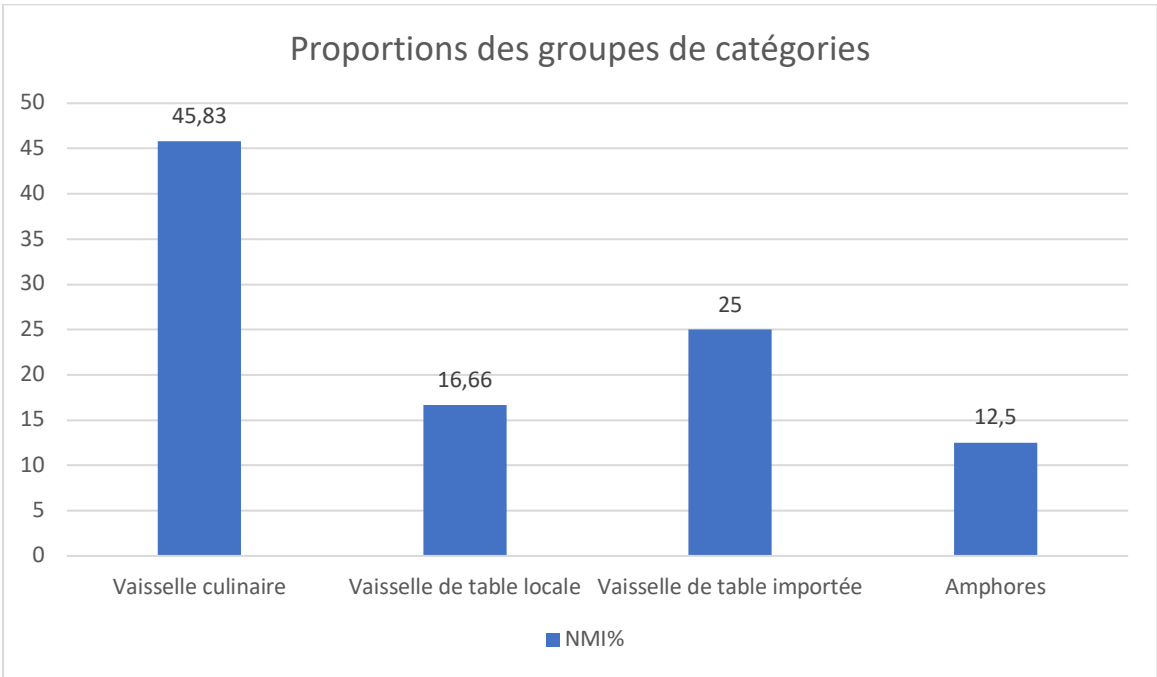
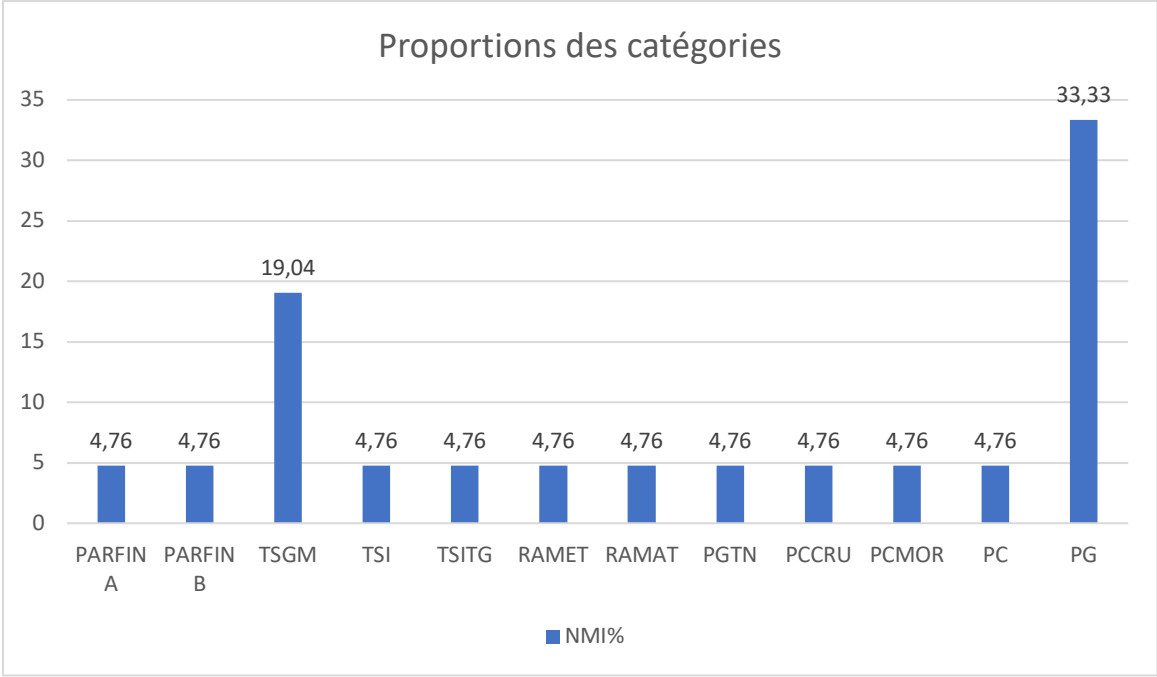
Fig. 57: Local 13 : stockage.

NMI	Catégories	%
1	PARFIN A	4,76
1	PARFIN B	4,76
4	TSGM	19,04
1	TSI	4,76
1	TSITG	4,76
1	RAMET	4,76
1	RAMAT	4,76
1	PGTN	4,76
1	PCCRU	4,76
1	PCMOR	4,76
1	PC	4,76
7	PG	33,33
21		100%

NMI	Catégories	%
11	Vaisselle culinaire	45,83
4	Vaisselle de table locale	16,66
6	Vaisselle de table importée	25
3	Amphores	12,5
24		100%

NMI	Formes	%
3	Ecuelles	18,75
2	Coupes	12,5
1	Bols	6,25
1	Bols à colerette	6,25
1	Mortiers	6,25
1	Gobelets	6,25
3	Pots	18,75
2	<i>Dolia</i>	12,5
1	Tonneaux	6,25
1	Cruches	6,25
16		100%

NMI	Fonctions	%
1	Consommation liquide individuel	5,26
3	Consommation solide+ semi-liquide ind.	15,78
2	Service liquide commun/stockage	10,52
4	Service solide+semi-liquide commun	21,05
1	Préparation	5,26
1	Cuisson	5,26
4	Stockage	21,05
0	Fermeture	0
3	Transport	15,78
19		100%



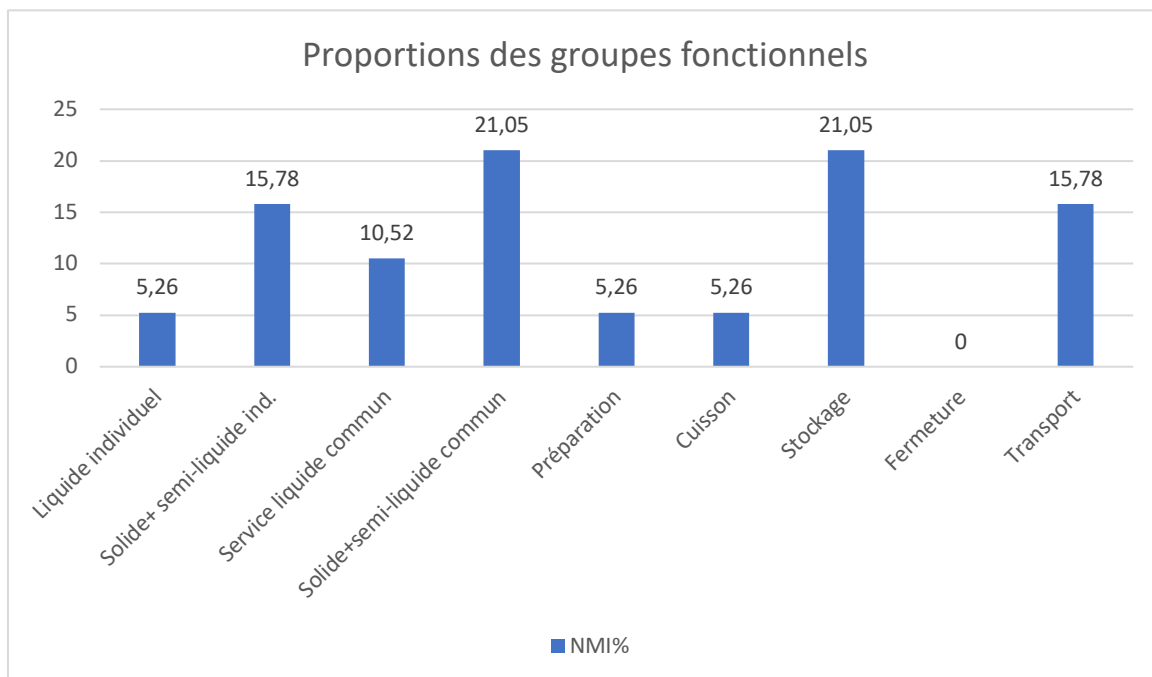
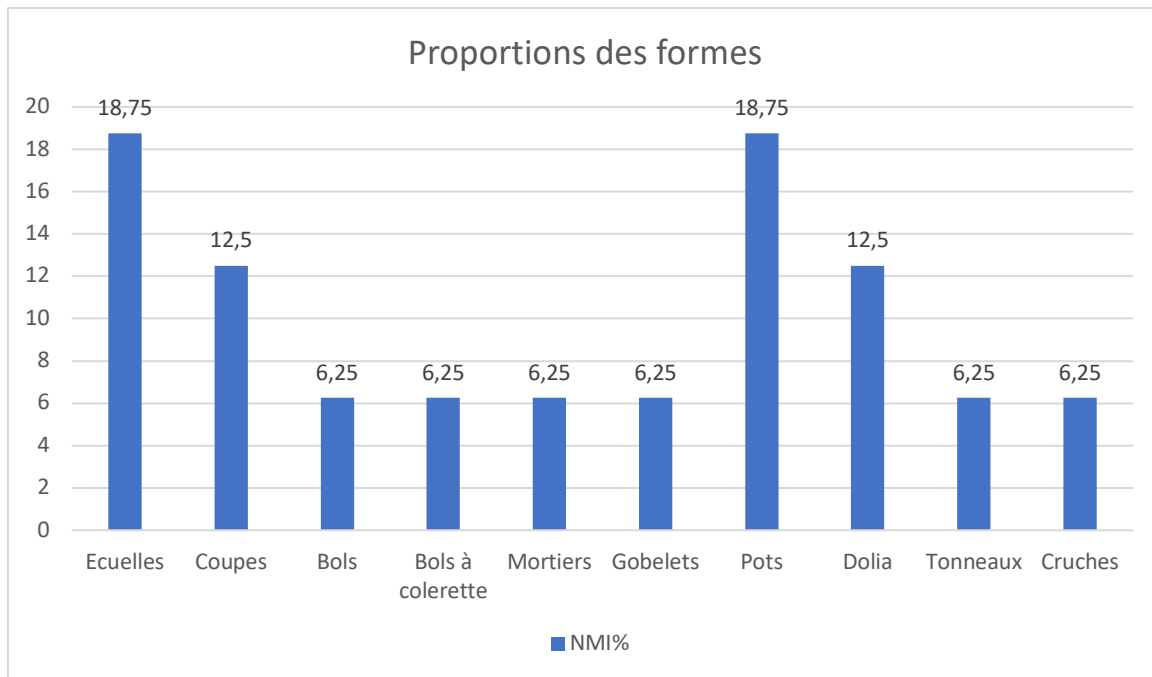


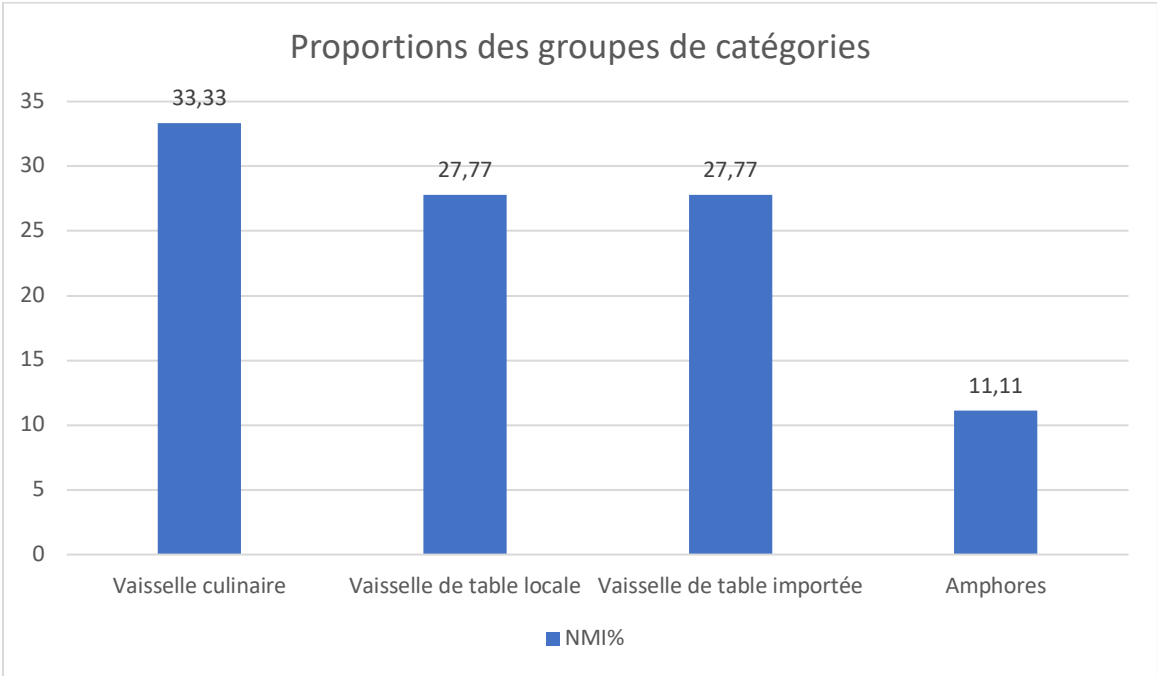
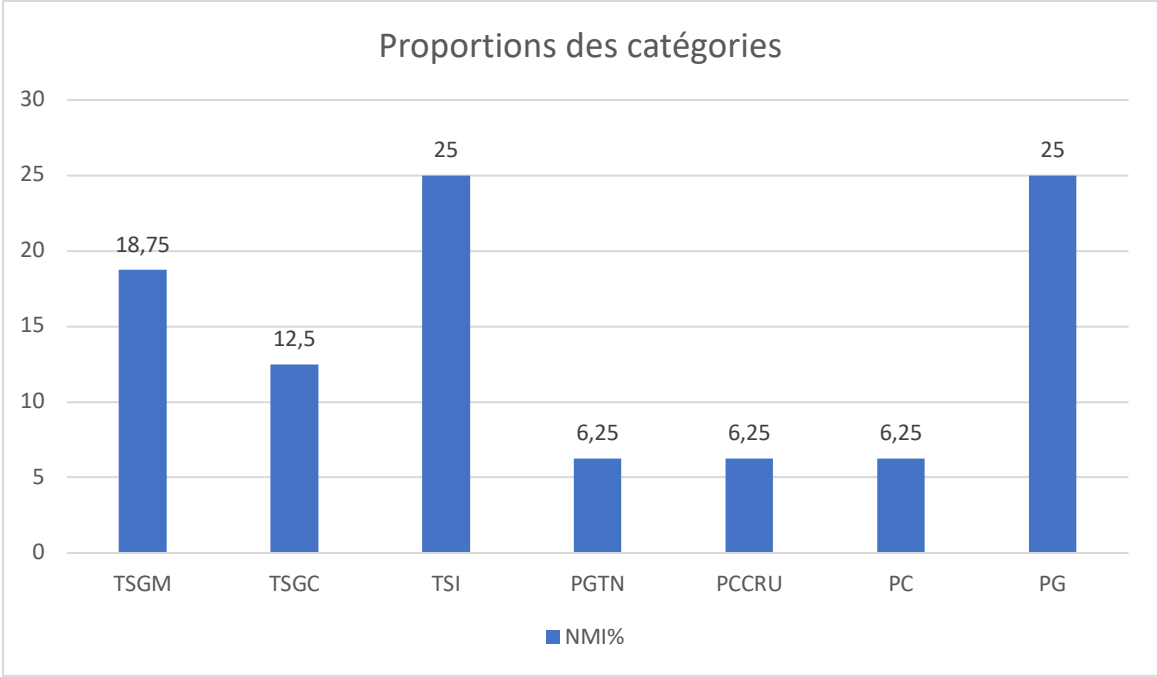
Fig. 58: Local 14: indéterminé.

NMI	Catégories	%
3	TSGM	18,75
2	TSGC	12,5
4	TSI	25
1	PGTN	6,25
1	PCCRU	6,25
1	PC	6,25
4	PG	25
16		100%

NMI	Catégories	%
6	Vaisselle culinaire	33,33
5	Vaisselle de table locale	27,77
5	Vaisselle de table importée	27,77
2	Amphores	11,11
18		100%

NMI	Formes	%
1	Assiettes	8,33
1	Plats	8,33
2	Ecuelles	16,66
1	Marmites	8,33
1	Coupes	8,33
5	Bols	41,66
1	Pots	8,33
1	Tonneaux	8,33
1	Cruches	8,33
12		100%

NMI	Fonctions	%
1	Consommation liquide individuel	6,66
6	Consommation solide+ semi-liquide ind.	40
2	Service liquide commun/stockage	13,33
3	Service solide+semi-liquide commun	20
0	Préparation	0
2	Cuisson	13,33
0	Stockage	0
0	Fermeture	0
1	Transport	6,66
15		100%



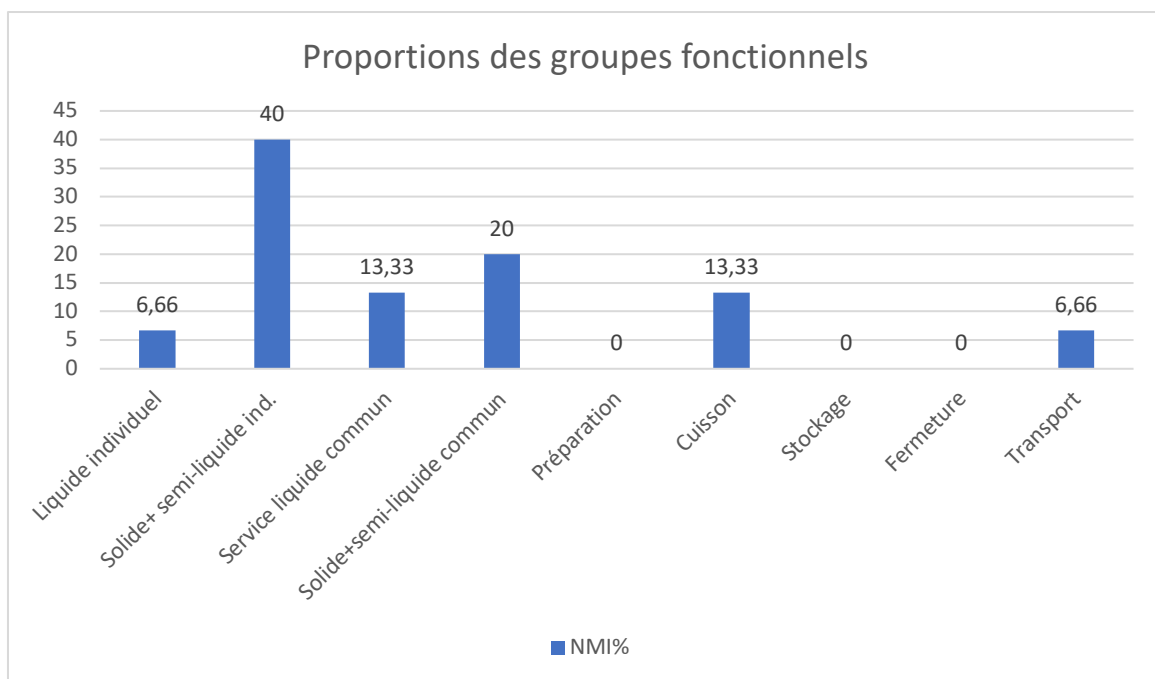
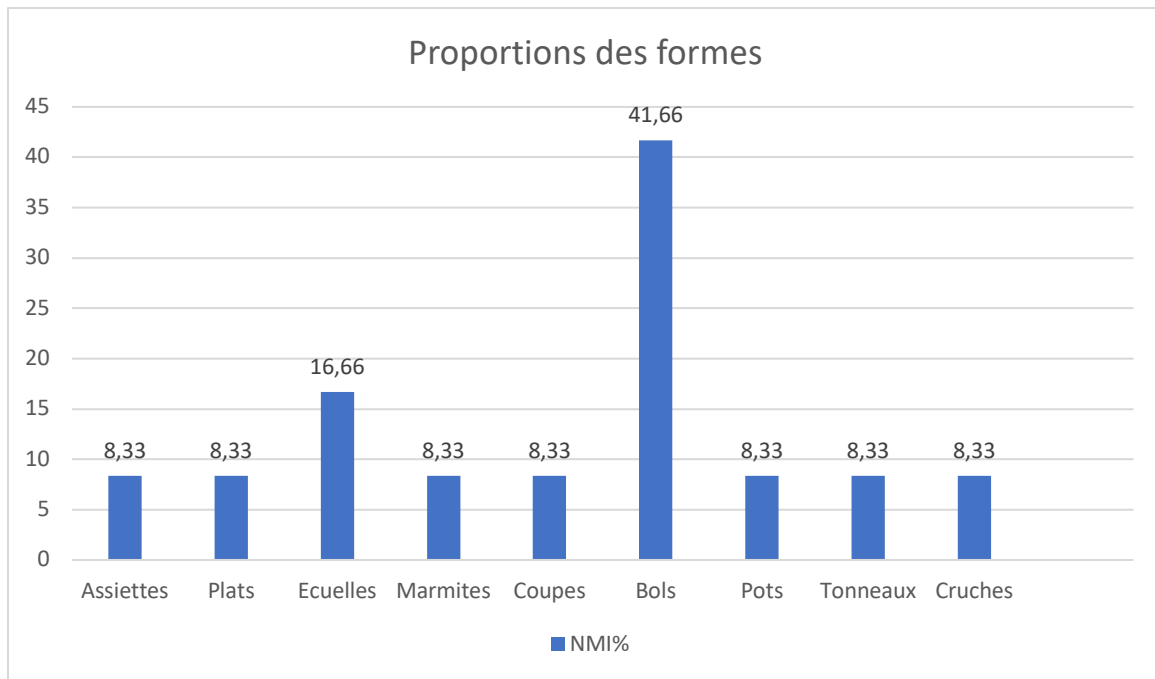


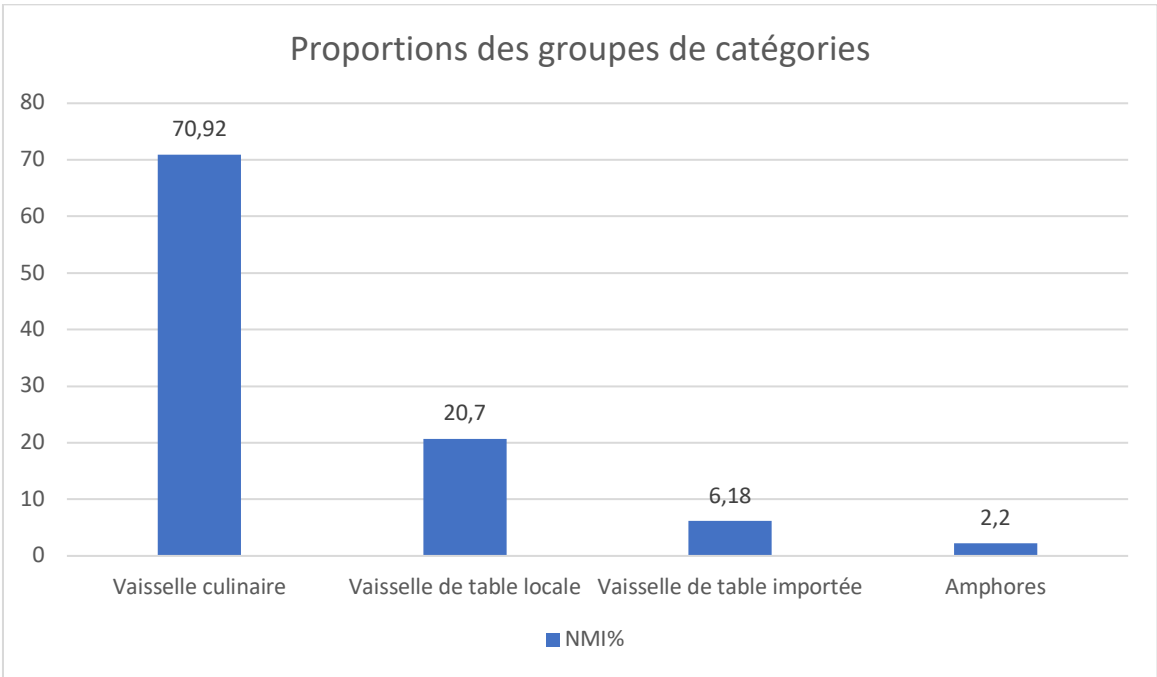
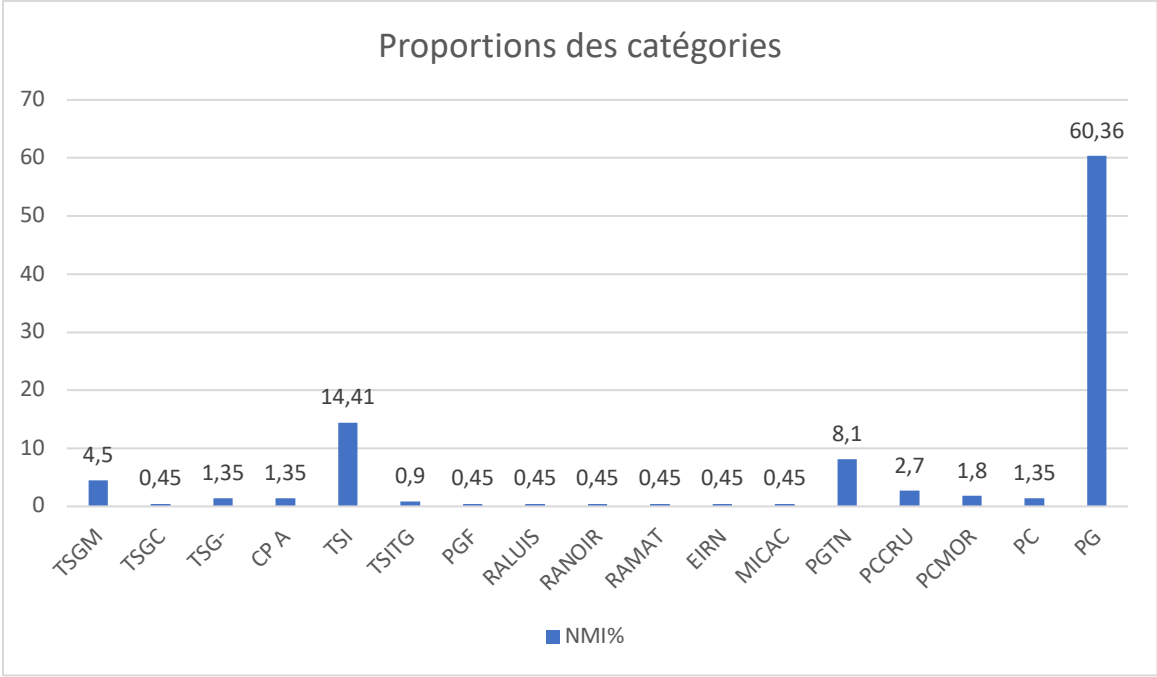
Fig. 59: Local 19: cour.

NMI	Catégories	%
10	TSGM	4,5
1	TSGC	0,45
3	TSG-	1,35
3	CP A	1,35
32	TSI	14,41
2	TSITG	0,9
1	PGF	0,45
1	RALUIS	0,45
1	RANOIR	0,45
1	RAMAT	0,45
1	EIRN	0,45
1	MICAC	0,45
18	PGTN	8,1
6	PCCRU	2,7
4	PCMOR	1,8
3	PC	1,35
134	PG	60,36
222		100%

NMI	Catégories	%
161	Vaisselle culinaire	70,92
47	Vaisselle de table locale	20,7
14	Vaisselle de table importée	6,18
5	Amphores	2,2
227		100%

NMI	Formes	%
8	Assiettes	4
1	Plats	0,5
72	Ecuellen	36,5
21	Marmites	10,65
8	Coupes	4,06
40	Bols	20,3
1	Bols à colerette	0,5
1	Bols à marli	0,5
4	Mortiers	2
5	Gobelets	2,5
28	Pots	14,2
3	<i>Dolia</i>	1,52
1	Tonneaux	0,5
6	Cruches	3
1	Pichets	0,5
6	Couvercles	3
197		100%

NMI	Fonctions	%
6	Consommation liquide individuel	2,85
99	Consommation solide+ semi-liquide ind.	47,14
8	Service liquide commun/stockage	3,8
18	Service solide+semi-liquide commun	8,57
15	Préparation	7,14
31	Cuisson	14,76
22	Stockage	10,47
6	Fermeture	2,85
5	Transport	2,38
210		100%



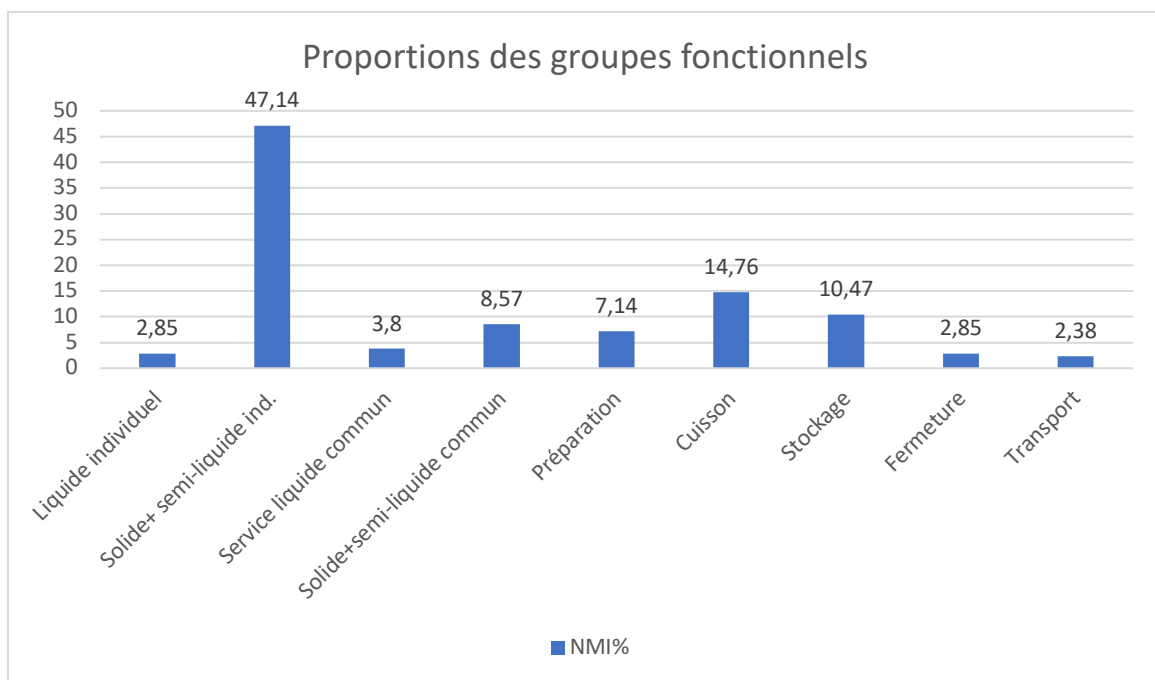
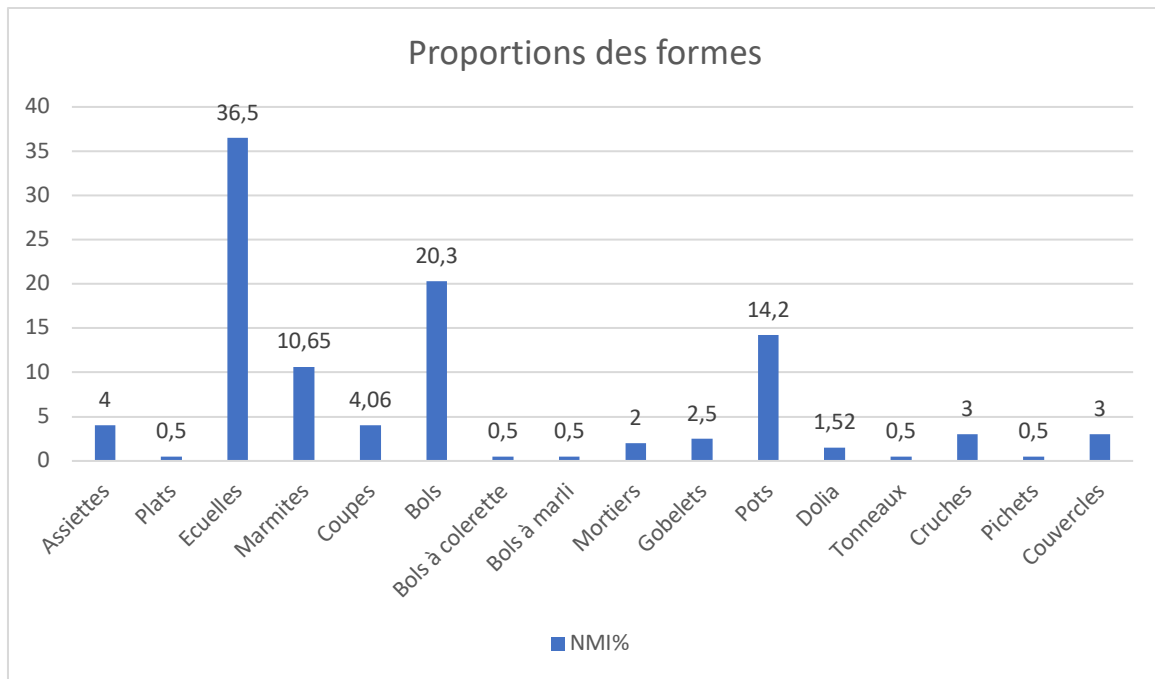


Fig. 60: Proposition d'attribution fonctionnelle des locaux de la période C-1.



4.2.5. Période C-2 (180/200 ap. J.-C.)

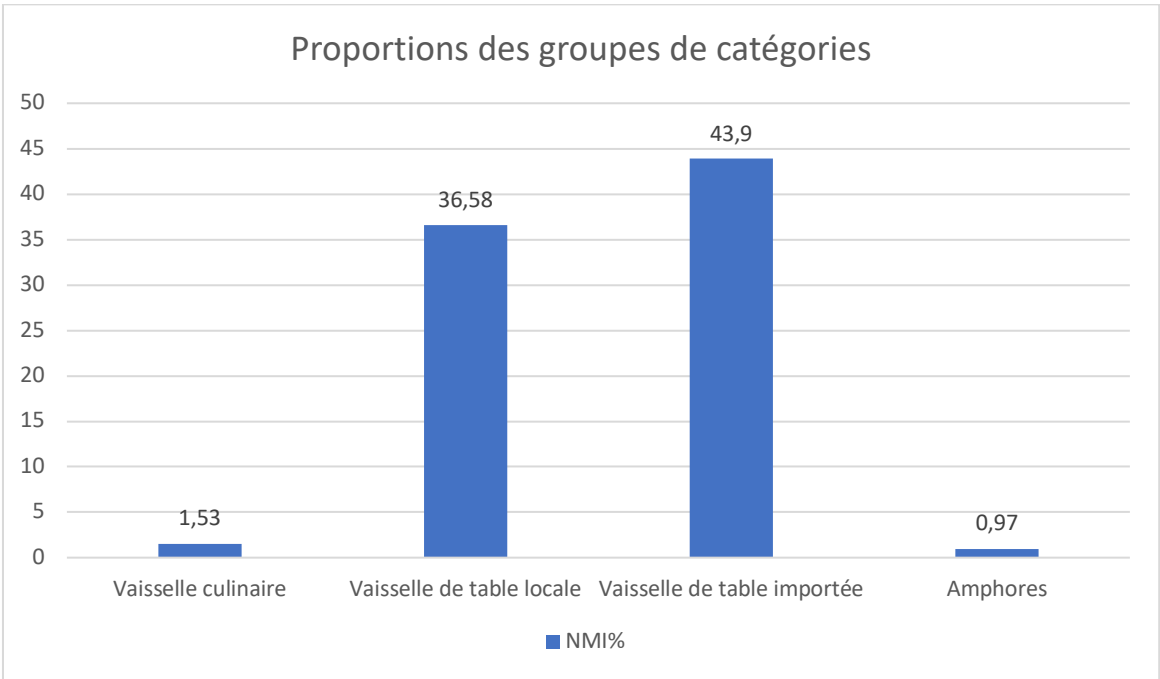
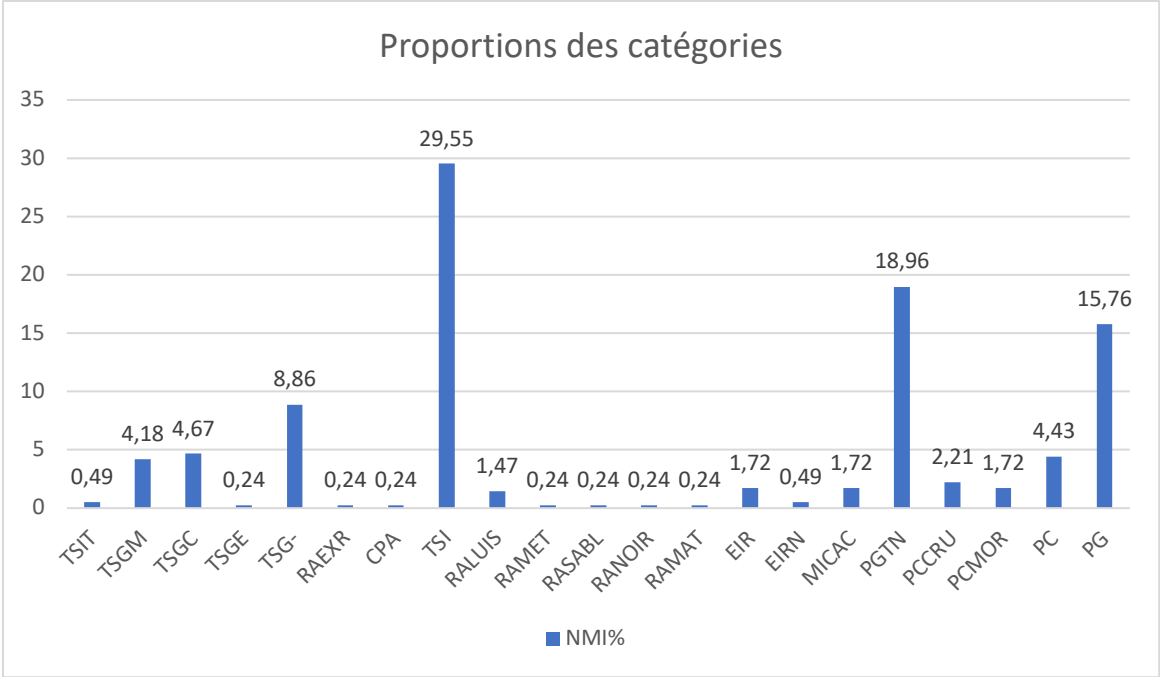
Fig. 61: Locaux 4 et 5: couloir et indéterminé.

NMI	Catégories	%
2	TSIT	0,49
17	TSGM	4,18
19	TSGC	4,67
1	TSGE	0,24
36	TSG-	8,86
1	RAEXR	0,24
11	CPA	0,24
120	TSI	29,55
6	RALUIS	1,47
1	RAMET	0,24
1	RASABL	0,24
1	RANOIR	0,24
1	RAMAT	0,24
7	EIR	1,72
2	EIRN	0,49
7	MICAC	1,72
77	PGTN	18,96
9	PCCRU	2,21
7	PCMOR	1,72
18	PC	4,43
64	PG	15,76
406		100%

NMI	Catégories	%
76	Vaisselle culinaire	1,53
150	Vaisselle de table locale	36,58
180	Vaisselle de table importée	43,9
4	Amphores	0,97
410		100%

NMI	Formes	%
23	Assiettes	5,66
15	Plats	3,69
9	Ecuelles	2,21
6	Marmites	1,47
17	Coupes	4,18
159	Bols	39,16
3	Bols à colerette	0,73
1	Bols à marli	0,24
9	Mortiers	2,21
9	Gobelets	2,21
94	Pots	23,15
8	<i>Dolia</i>	1,97
24	Tonneaux	5,91
9	Cruches	2,21
6	Bouteille	1,47
14	Couvercles	3,44
406		100%

NMI	Fonctions	%
25	Consommation liquide individuel	6,14
137	Consommation solide+ semi-liquide ind.	33,66
39	Service liquide commun/stockage	9,58
52	Service solide+semi-liquide commun	12,77
10	Préparation	2,45
49	Cuisson	12,03
75	Stockage	18,42
16	Fermeture	3,93
4	Transport	0,98
407		100%



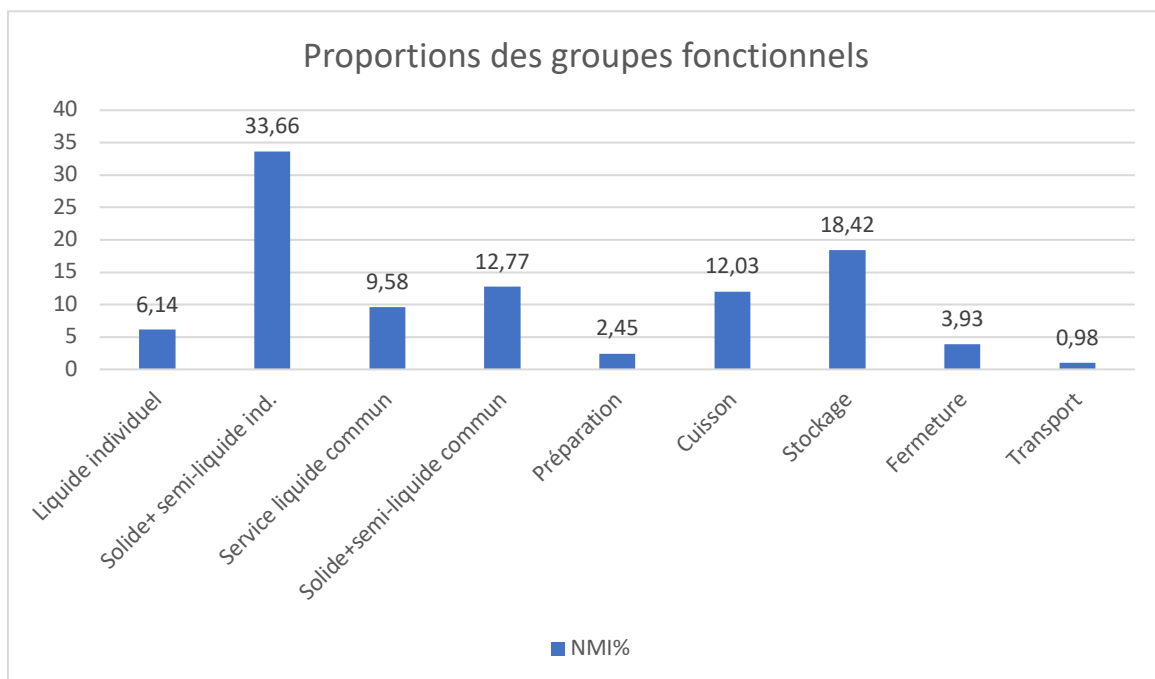
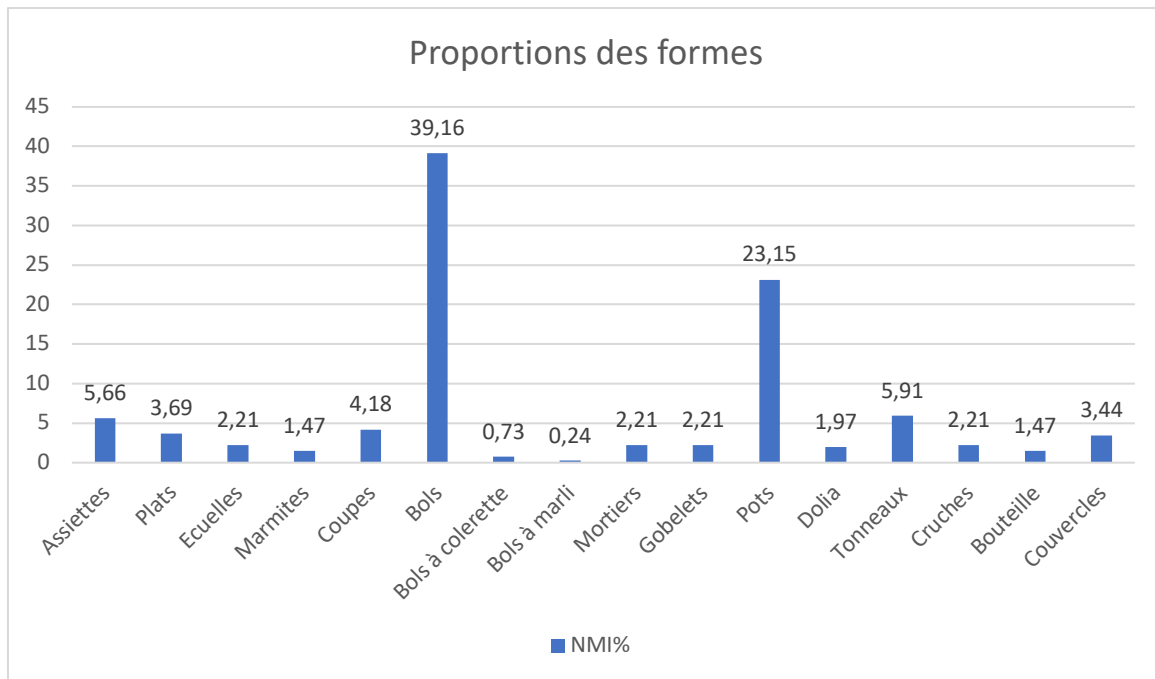


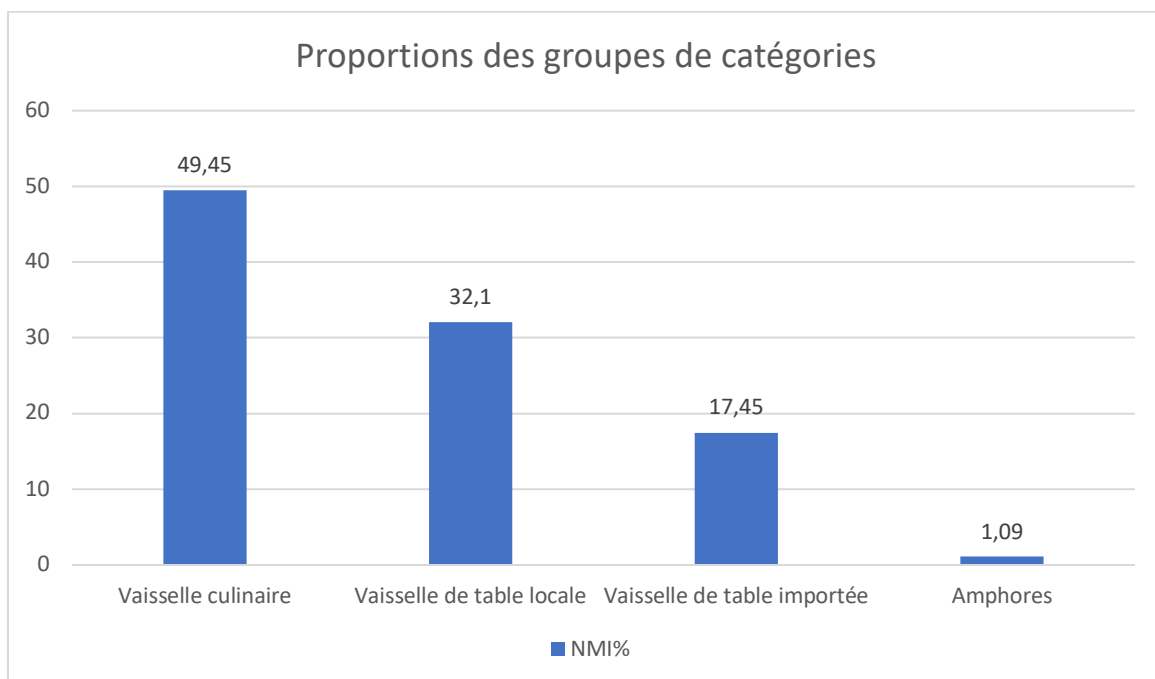
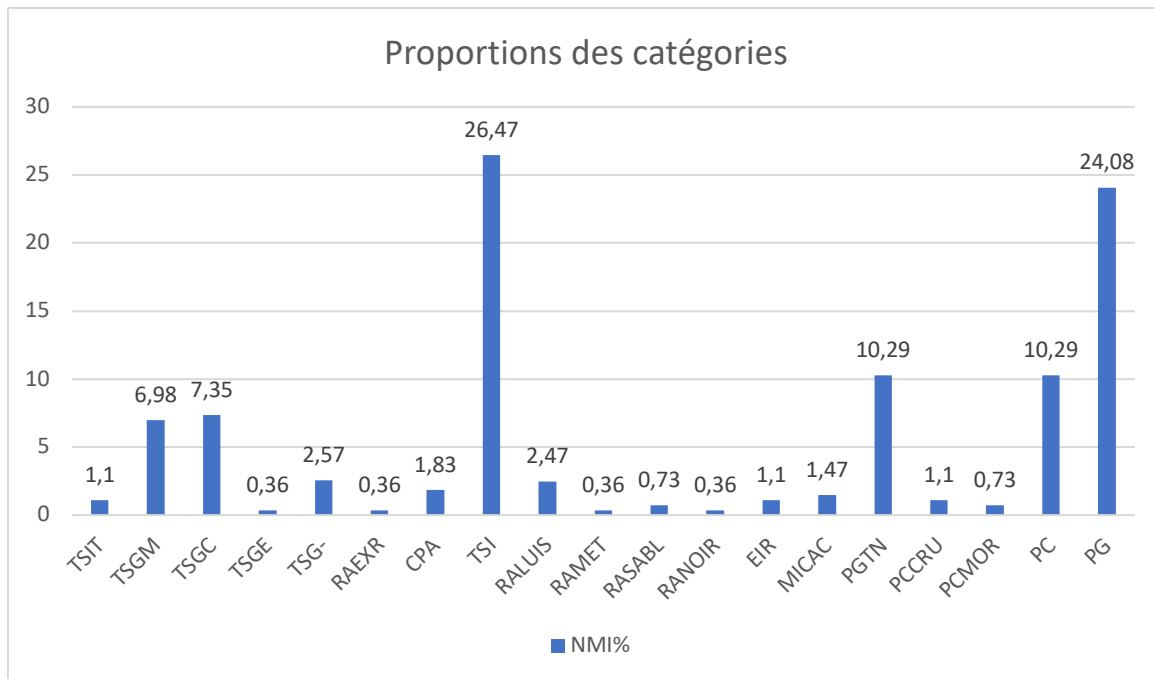
Fig. 62: Locaux 12: atelier artisanal (artisanat culinaire ?).

NMI	Catégories	%
3	TSIT	1,1
19	TSGM	6,98
20	TSGC	7,35
1	TSGE	0,36
7	TSG-	2,57
1	RAEXR	0,36
5	CPA	1,83
72	TSI	26,47
7	RALUIS	2,47
1	RAMET	0,36
2	RASABL	0,73
1	RANOIR	0,36
3	EIR	1,1
4	MICAC	1,47
28	PGTN	10,29
3	PCCRU	1,1
2	PCMOR	0,73
28	PC	10,29
68	PG	24,08
272		100%

NMI	Catégories	%
136	Vaisselle culinaire	49,45
88	Vaisselle de table locale	32,1
48	Vaisselle de table importée	17,45
3	Amphores	1,09
275		100%

NMI	Formes	%
15	Assiettes	5,72
5	Plats	1,9
23	Ecuelles	8,78
2	Marmites	0,76
14	Coupes	5,34
90	Bols	34,35
2	Bols à colerette	0,76
3	Mortiers	1,14
9	Gobelets	3,43
74	Pots	28,24
5	<i>Dolia</i>	1,9
7	Tonneaux	2,67
3	Cruches	1,14
1	Bouteille	0,38
1	Pichets	0,38
7	Couvercles	2,67
1	Bouchons	0,38
262		100%

NMI	Fonctions	%
10	Consommation liquide individuel	3,63
111	Consommation solide+ semi-liquide ind.	40,36
12	Service liquide commun/stockage	4,36
17	Service solide+semi-liquide commun	6,22
5	Préparation	1,81
51	Cuisson	18,54
56	Stockage	20,36
10	Fermeture	3,63
3	Transport	1,09
275		100%



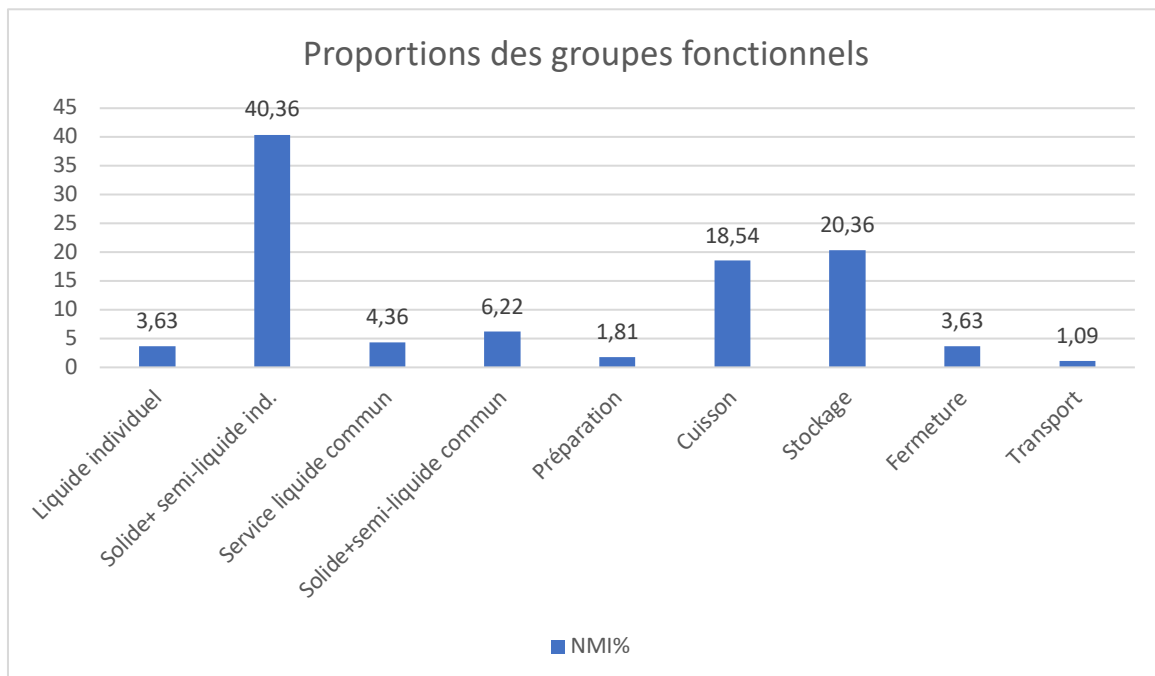
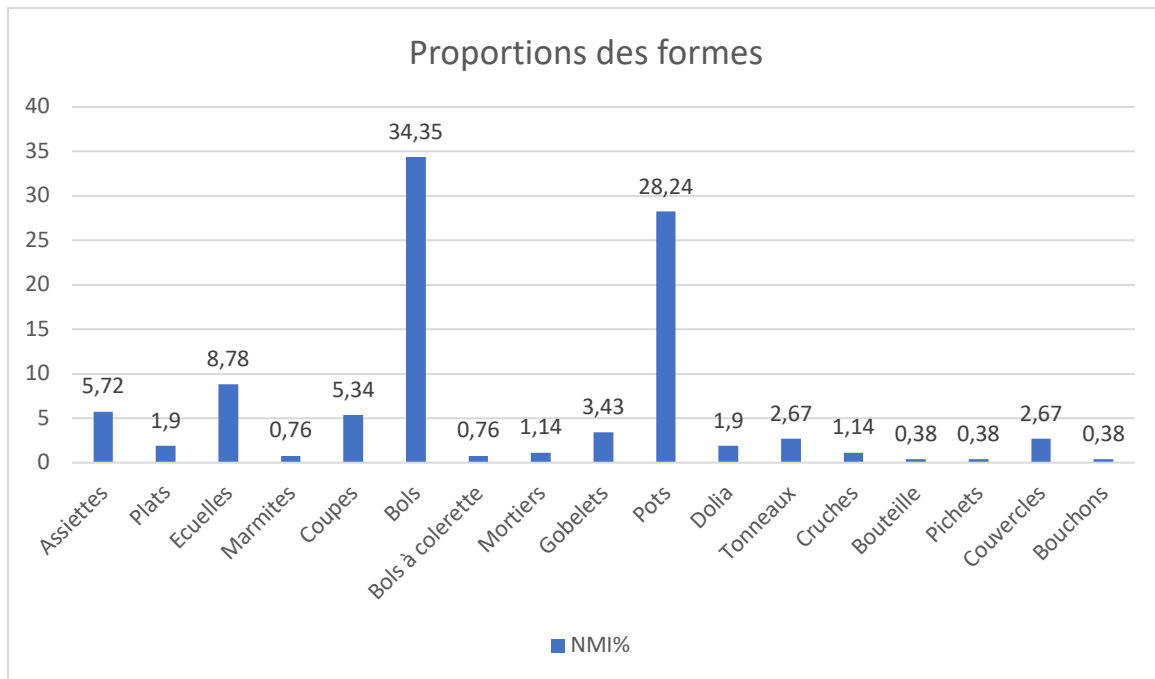


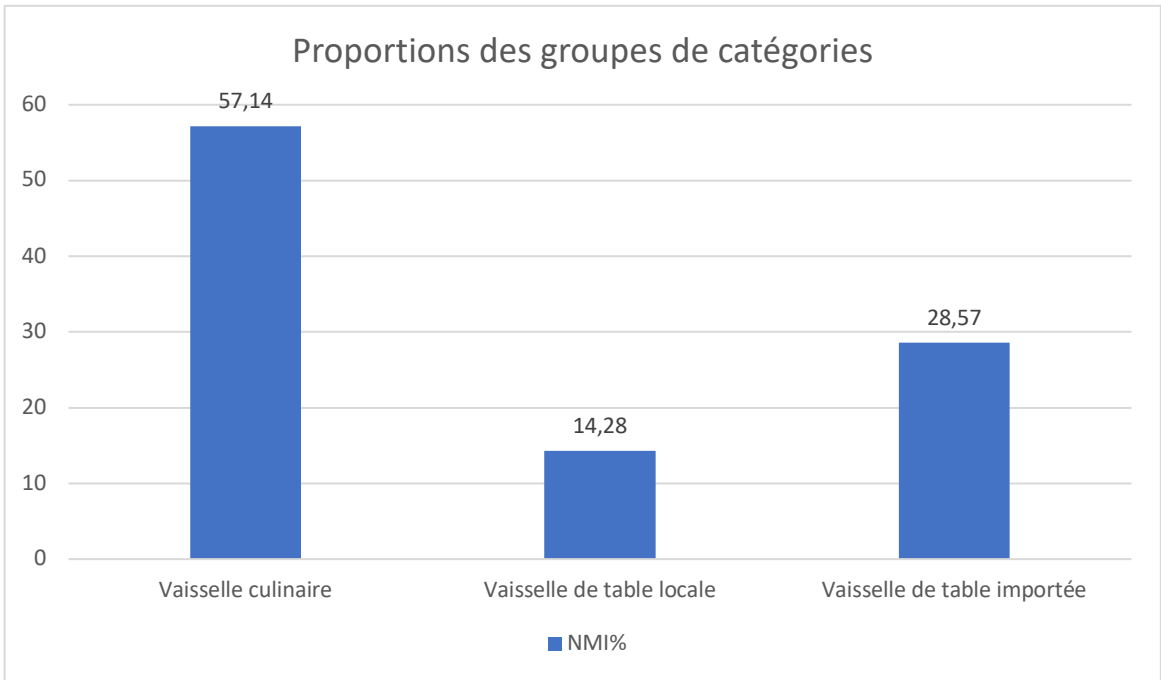
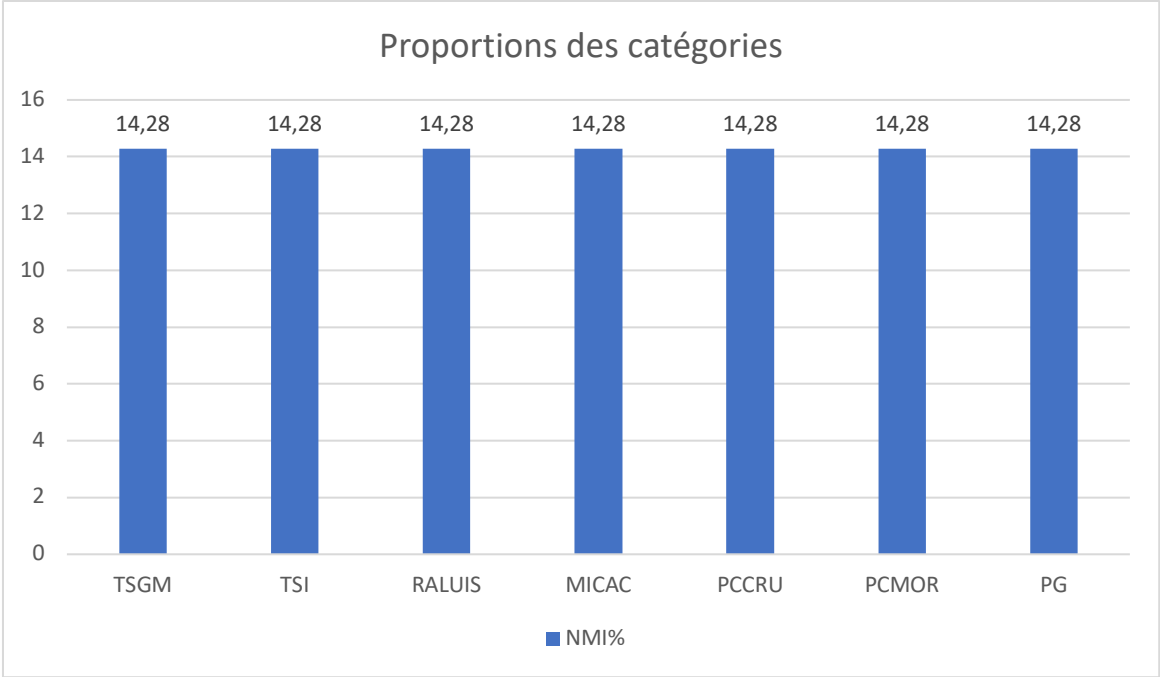
Fig. 63: Locaux 14: cuisine.

NMI	Catégories	%
1	TSGM	14,28
1	TSI	14,28
1	RALUIS	14,28
1	MICAC	14,28
1	PCCRU	14,28
1	PCMOR	14,28
1	PG	14,28
7		100%

NMI	Catégories	%
4	Vaisselle culinaire	57,14
1	Vaisselle de table locale	14,28
2	Vaisselle de table importée	28,57
7		100%

NMI	Formes	%
1	Bols	20
1	Mortiers	20
1	Gobelets	20
1	Pots	20
1	Cruches	20
5		100%

NMI	Fonctions	%
1	Consommation liquide individuel	20
1	Consommation solide+ semi-liquide ind.	20
0	Service liquide commun/stockage	0
1	Service solide+semi-liquide commun	20
1	Préparation	20
0	Cuisson	0
1	Stockage	20
0	Fermeture	0
0	Transport	0
5		100%



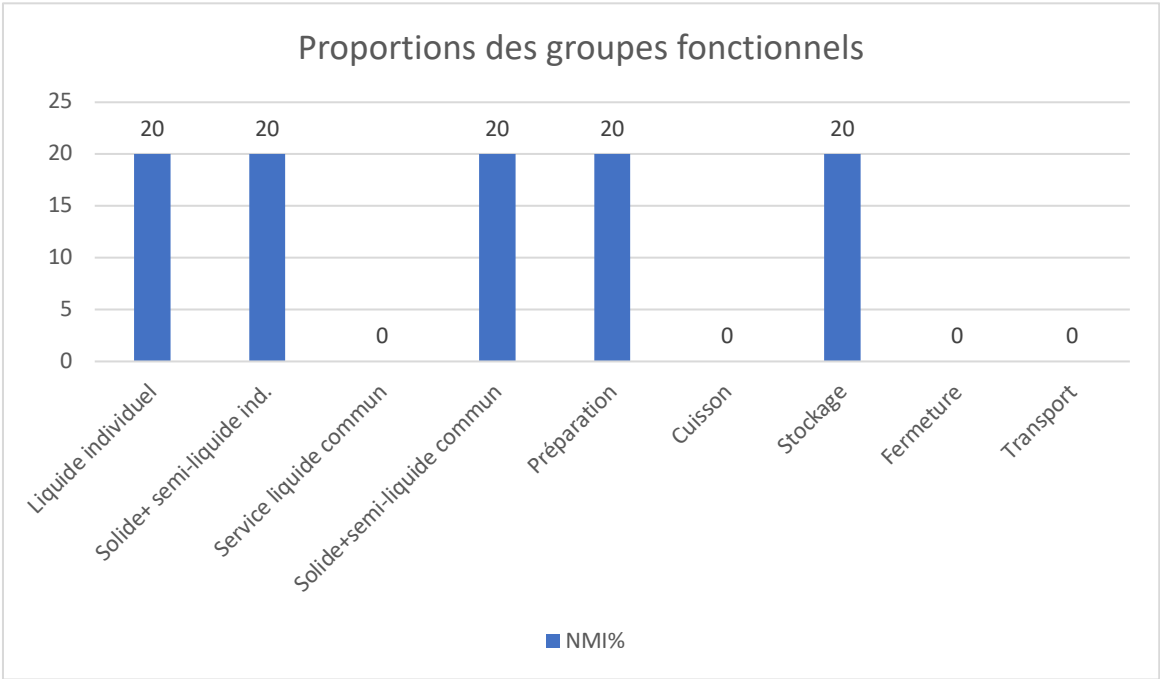
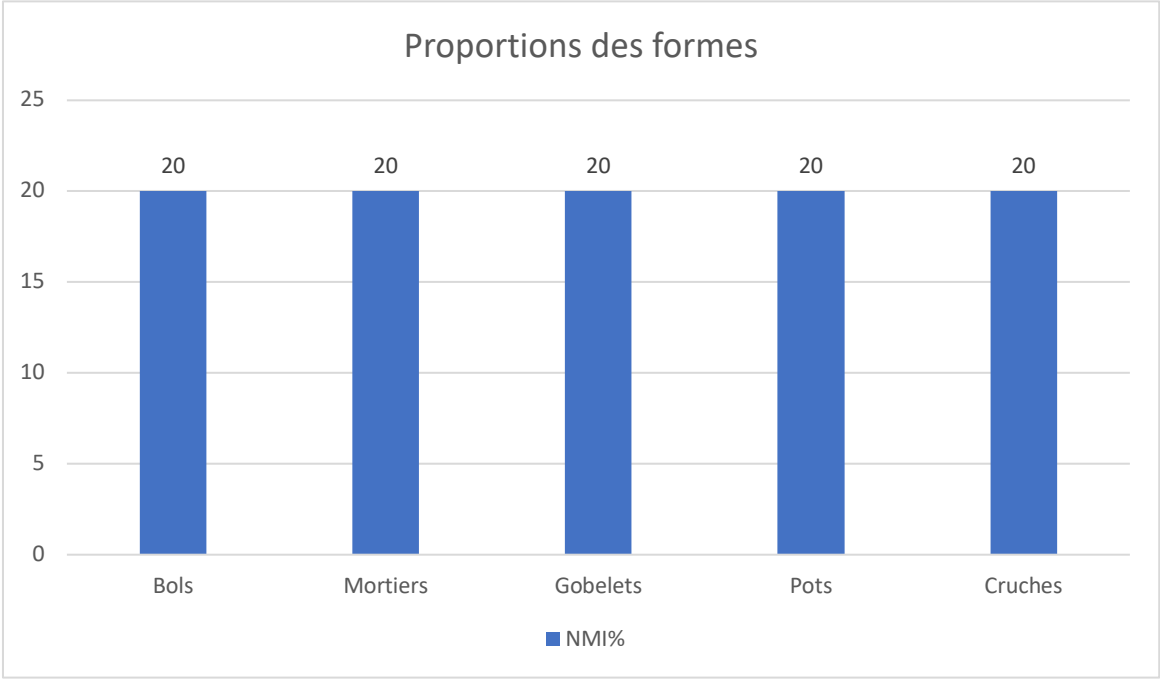


Fig. 64: Proposition d'attribution fonctionnelle des locaux de la période C-2.



4.2.6. Période C-3 (274 ap. J.-C.)

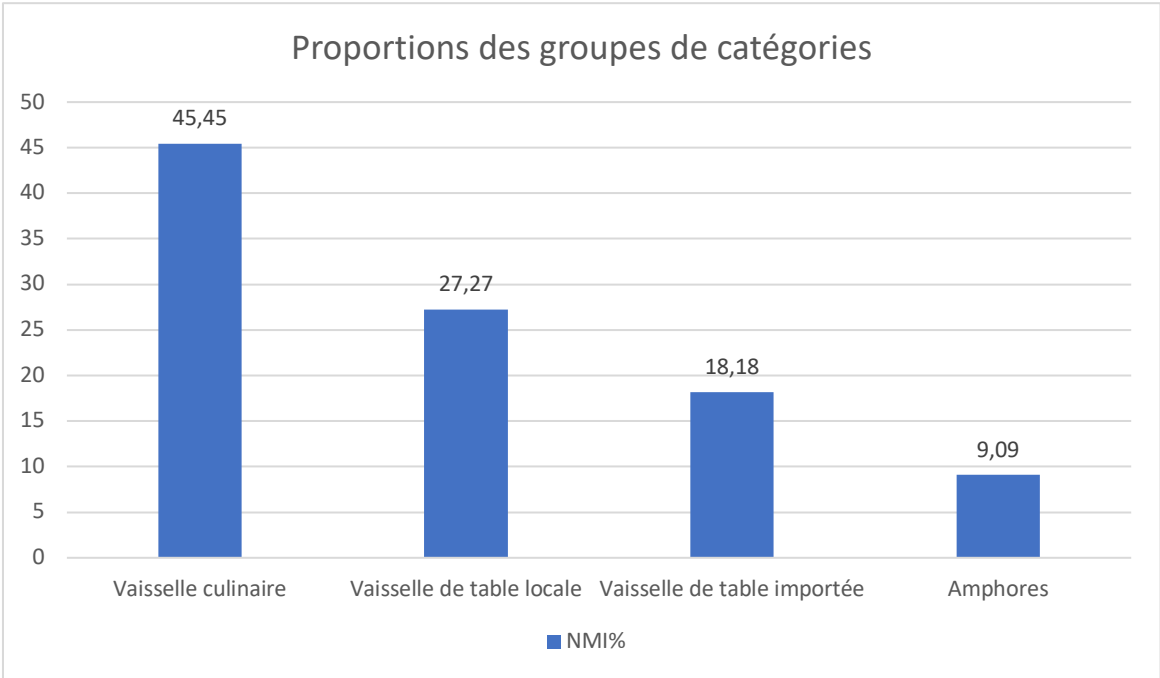
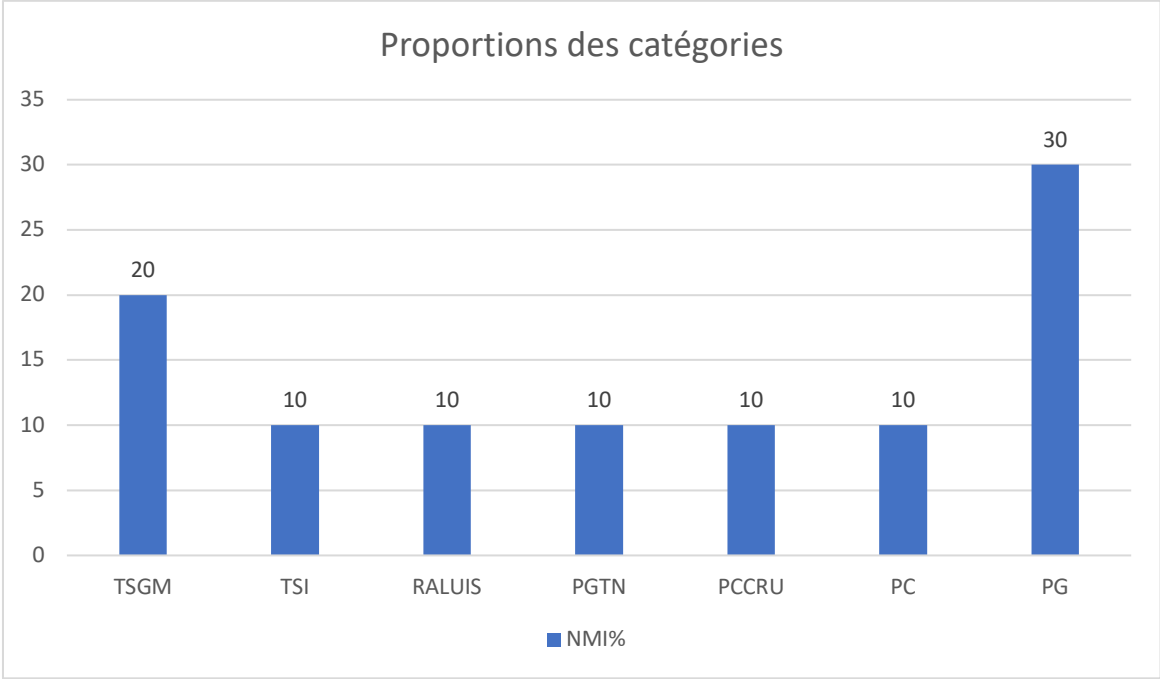
Fig. 65: Local 3: stockage.

NMI	Catégories	%
2	TSGM	20
1	TSI	10
1	RALUIS	10
1	PGTN	10
1	PCCRU	10
1	PC	10
3	PG	30
10		100%

NMI	Catégories	%
5	Vaisselle culinaire	45,45
3	Vaisselle de table locale	27,27
2	Vaisselle de table importée	18,18
1	Amphores	9,09
11		100%

NMI	Formes	%
1	Coupes	16,66
1	Bols	16,66
1	Pots	16,66
1	Cruches	16,66
2	Couvercles	33,33
6		100%

NMI	Fonctions	%
0	Consommation liquide individuel	0
0	Consommation solide+ semi-liquide ind.	0
1	Service liquide commun/stockage	14,28
2	Service solide+semi-liquide commun	28,57
0	Préparation	0
0	Cuisson	0
1	Stockage	14,28
2	Fermeture	28,57
1	Transport	14,28
7		100%



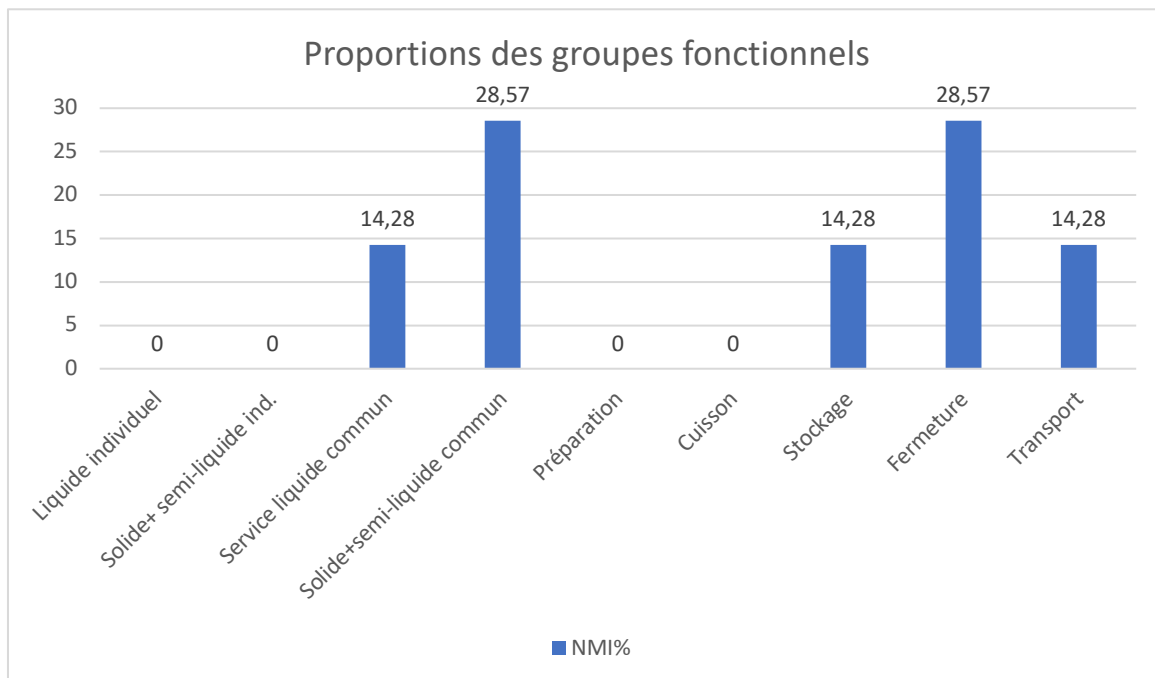
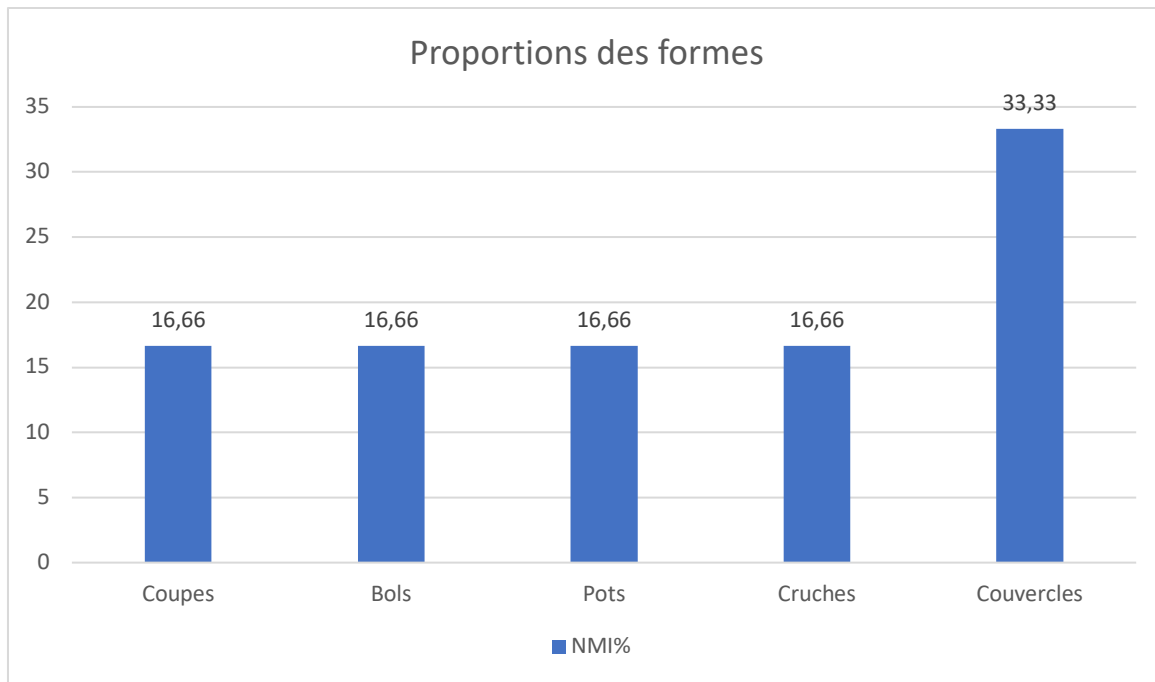


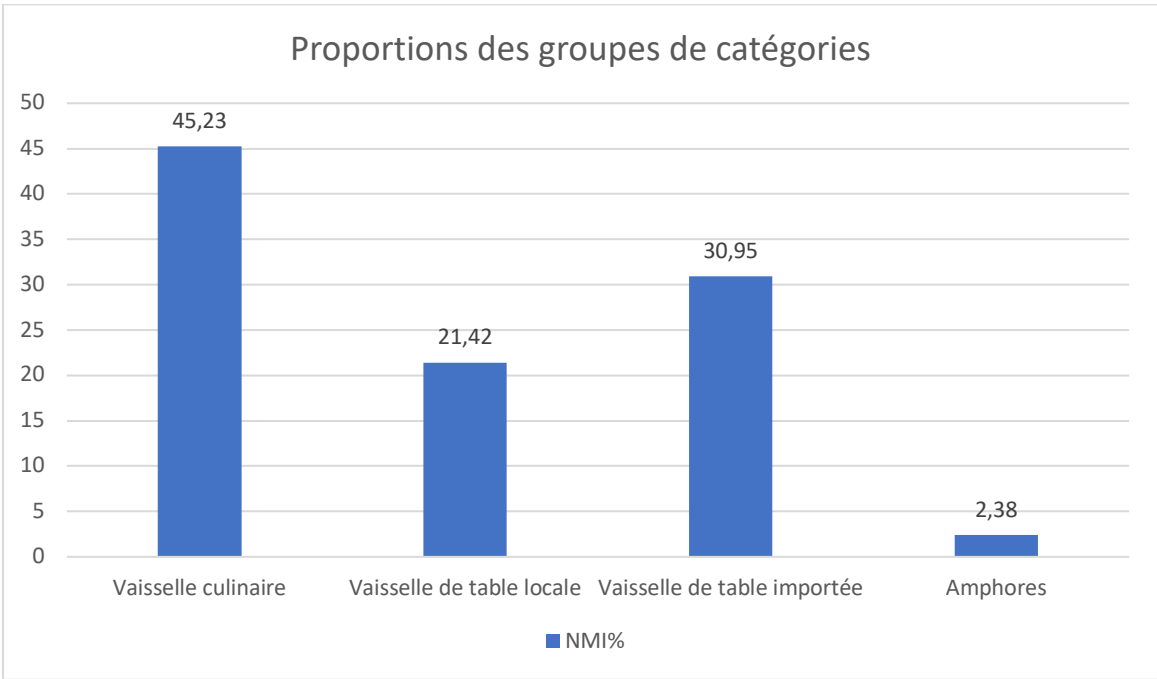
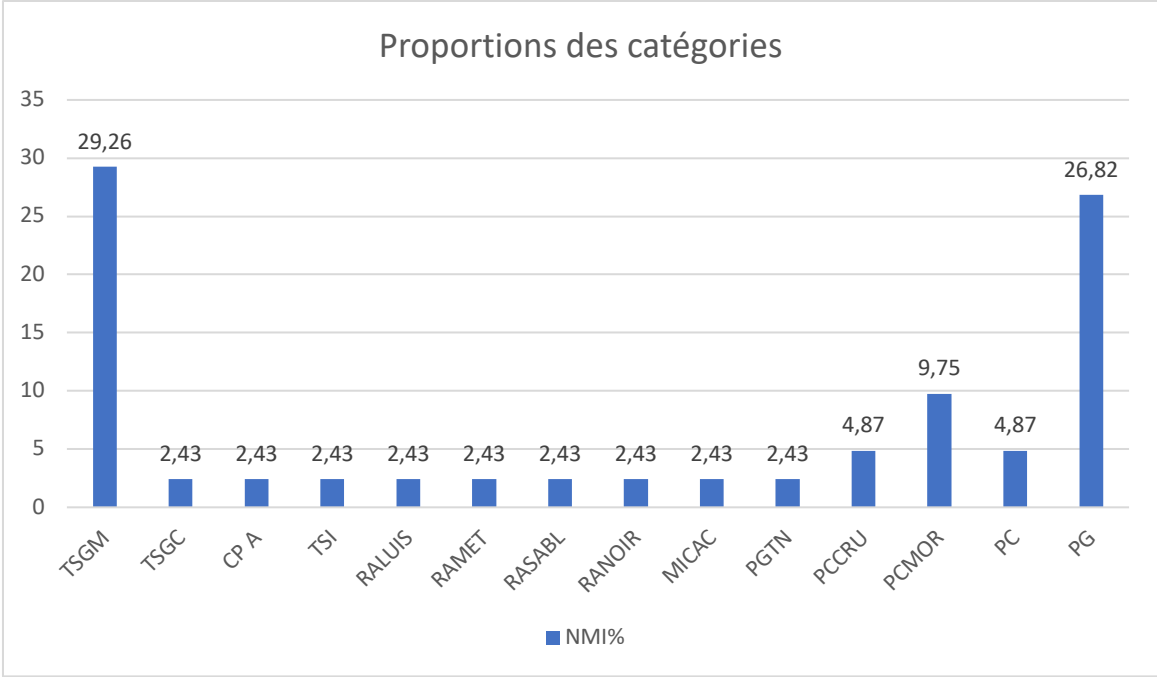
Fig. 66: Local 5: Indéterminé (culinaire ?).

NMI	Catégories	%
12	TSGM	29,26
1	TSGC	2,43
1	CP A	2,43
1	TSI	2,43
2	RALUIS	2,43
1	RAMET	2,43
1	RASABL	2,43
1	RANOIR	2,43
1	MICAC	2,43
1	PGTN	2,43
2	PCCRU	4,87
4	PCMOR	9,75
2	PC	4,87
11	PG	26,82
41		100%

NMI	Catégories	%
19	Vaisselle culinaire	45,23
9	Vaisselle de table locale	21,42
13	Vaisselle de table importée	30,95
1	Amphores	2,38
42		100%

NMI	Formes	%
5	Assiettes	13,15
6	Ecuelles	15,78
1	Marmites	2,63
5	Coupes	13,15
3	Bols	7,89
1	Bols à colerette	2,63
4	Mortiers	10,52
4	Gobelets	10,52
4	Pots	10,52
1	<i>Dolia</i>	2,63
1	Bouteilles	2,63
2	Cruches	5,26
1	Bouchons	2,63
38		100%

NMI	Fonctions	%
4	Consommation liquide individuel	10,25
7	Consommation solide+ semi-liquide ind.	17,94
3	Service liquide commun/stockage	7,69
13	Service solide+semi-liquide commun	33,33
4	Préparation	10,25
2	Cuisson	5,12
4	Stockage	10,25
1	Fermeture	2,56
1	Transport	2,56
39		100%



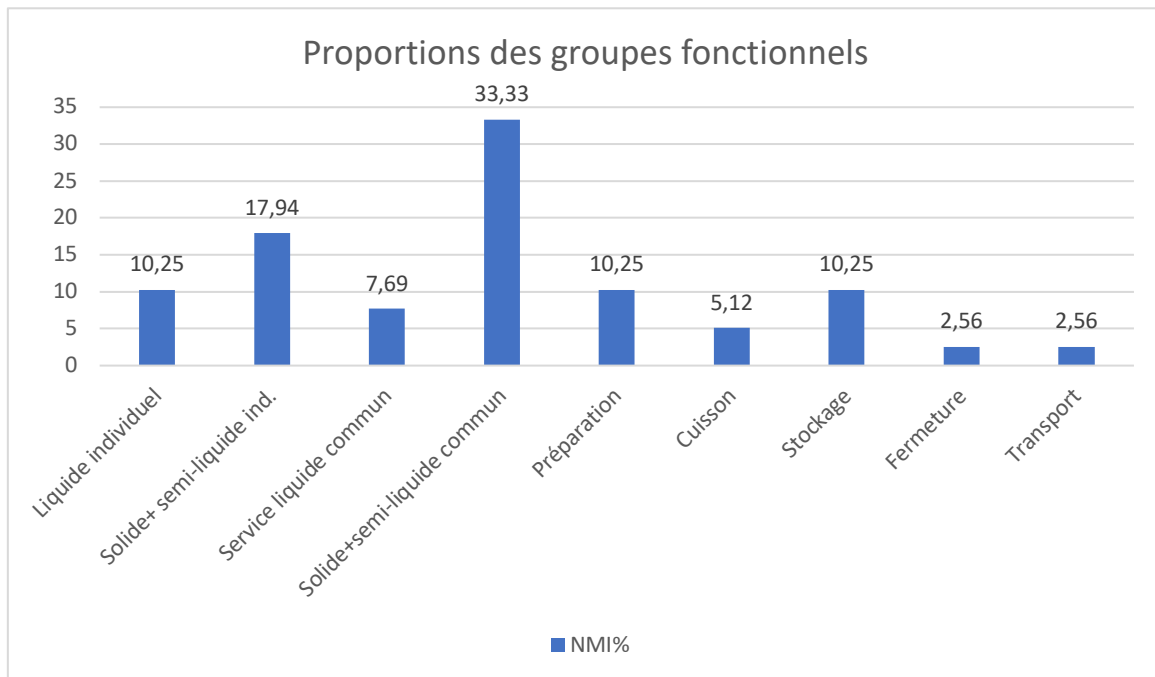
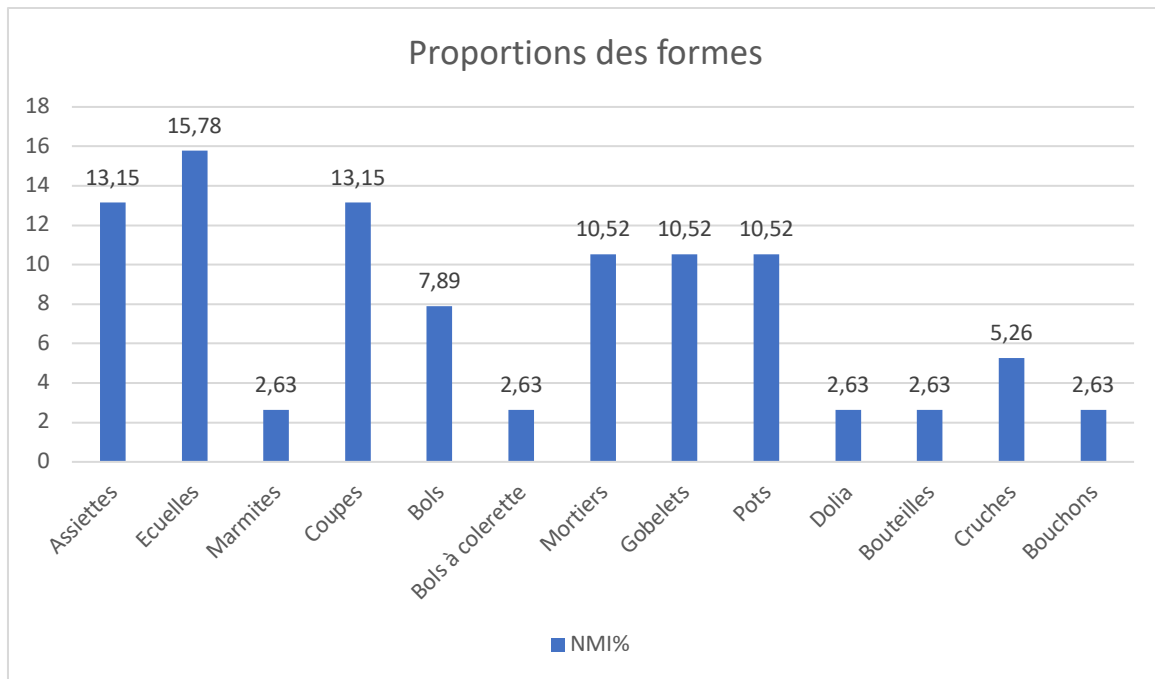


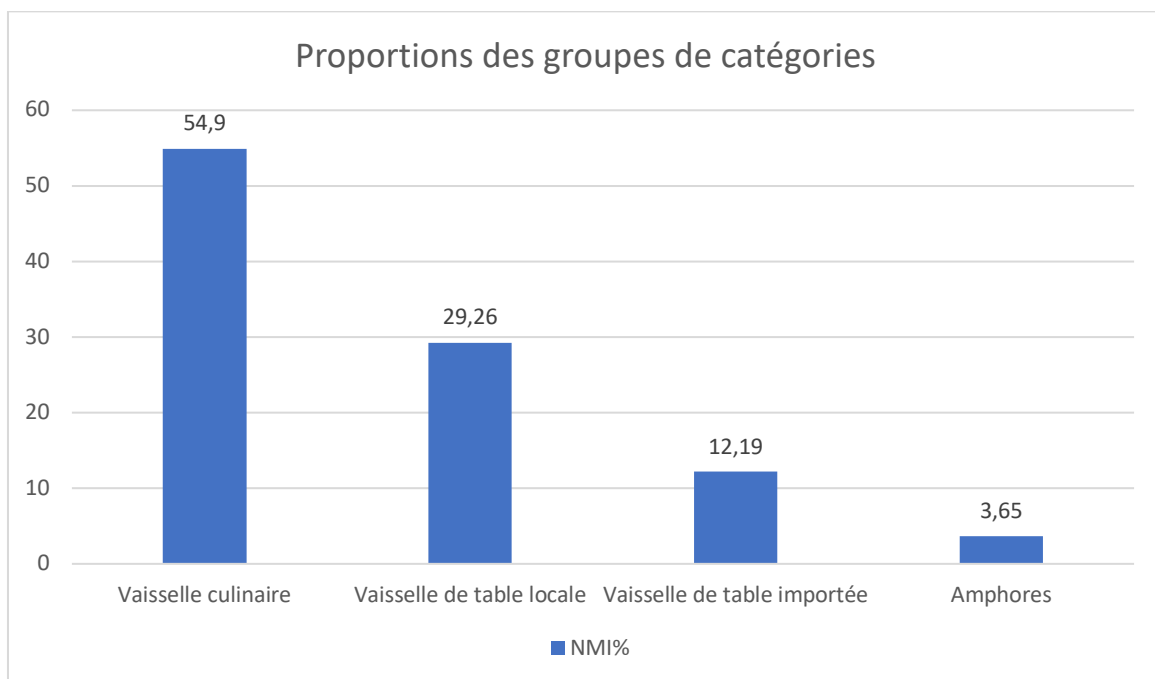
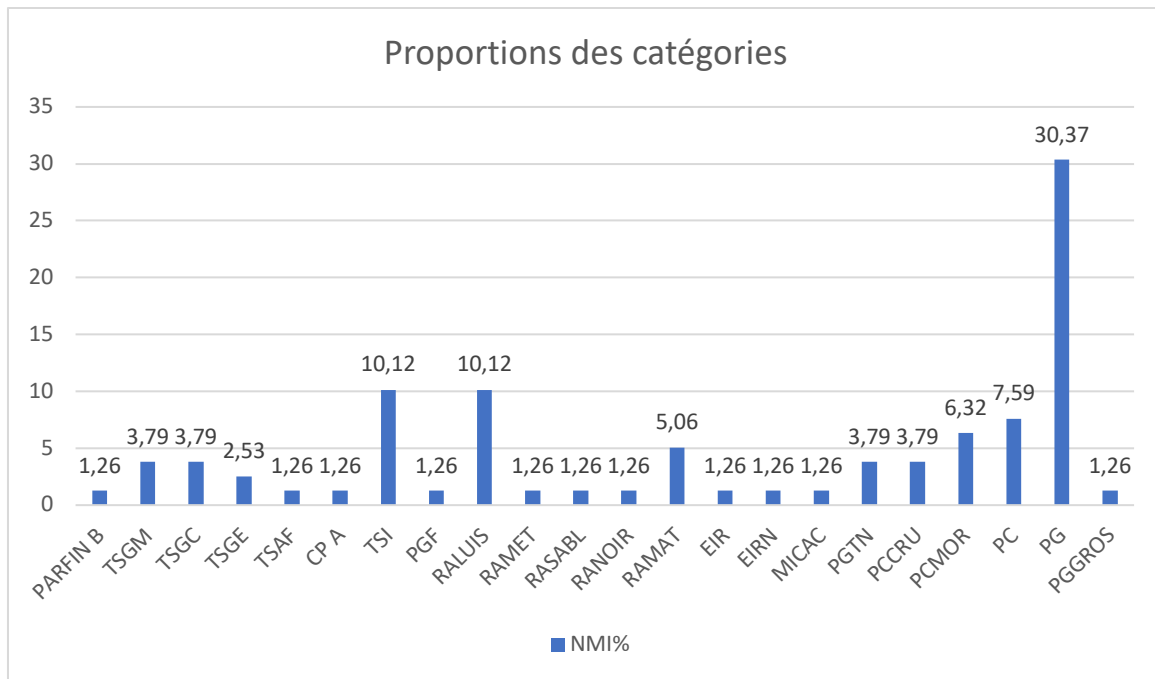
Fig. 67: Local 6: cour.

NMI	Catégories	%
1	PARFIN B	1,26
3	TSGM	3,79
3	TSGC	3,79
2	TSGE	2,53
1	TSAF	1,26
1	CP A	1,26
8	TSI	10,12
1	PGF	1,26
8	RALUIS	10,12
1	RAMET	1,26
1	RASABL	1,26
1	RANOIR	1,26
4	RAMAT	5,06
1	EIR	1,26
1	EIRN	1,26
1	MICAC	1,26
3	PGTN	3,79
3	PCCRU	3,79
5	PCMOR	6,32
6	PC	7,59
24	PG	30,37
1	PGGROS	1,26
79		100%

NMI	Catégories	%
45	Vaisselle culinaire	54,9
24	Vaisselle de table locale	29,26
10	Vaisselle de table importée	12,19
3	Amphores	3,65
82		100%

NMI	Formes	%
4	Assiettes	4,87
2	Plats	2,43
13	Ecuelles	15,85
4	Coupes	4,87
11	Bols	13,41
6	Mortiers	7,31
10	Gobelets	12,19
18	Pots	21,95
1	<i>Dolia</i>	1,21
3	Tonneaux	3,65
4	Cruches	4,87
1	Couvercles	1,21
77		100%

NMI	Fonctions	%
10	Consommation liquide individuel	12,5
19	Consommation solide+ semi-liquide ind.	23,75
7	Service liquide commun/stockage	8,75
13	Service solide+semi-liquide commun	16,25
6	Préparation	7,5
3	Cuisson	3,75
18	Stockage	22,5
1	Fermeture	1,25
3	Transport	3,75
80		100%



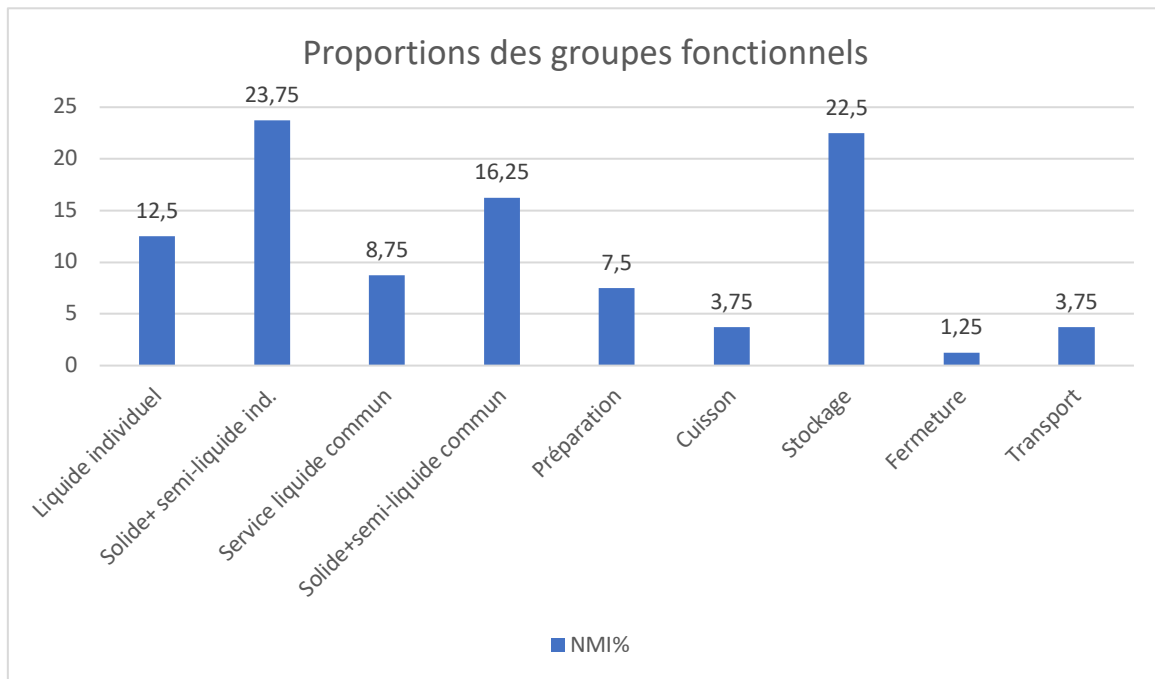
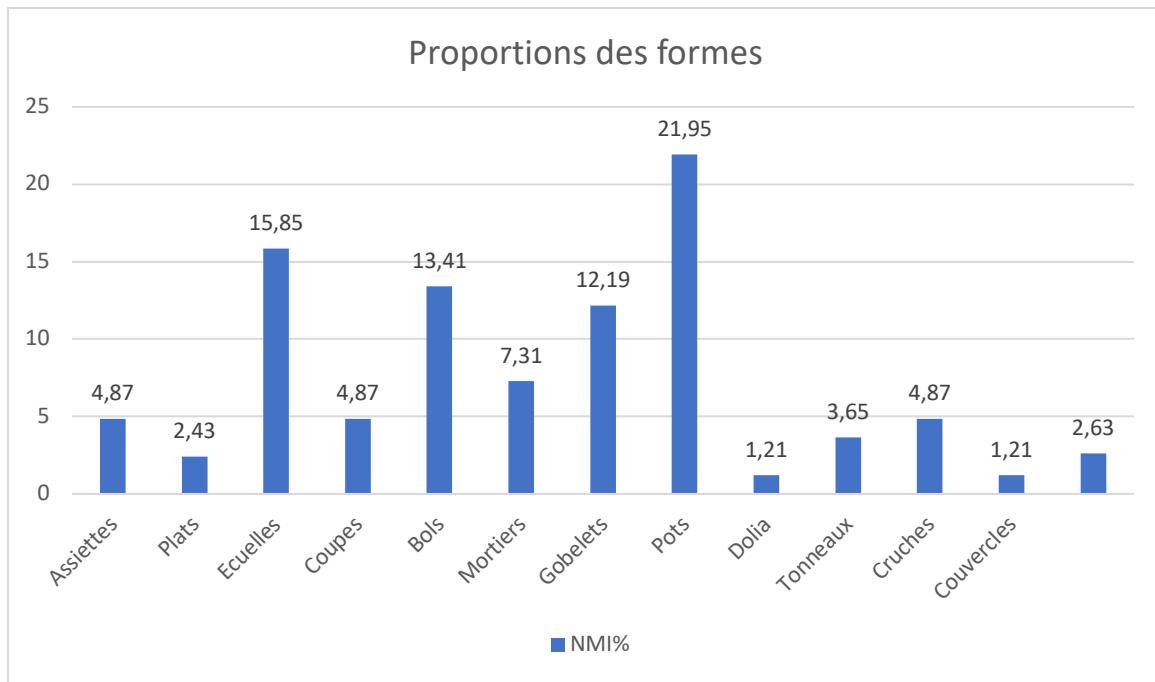


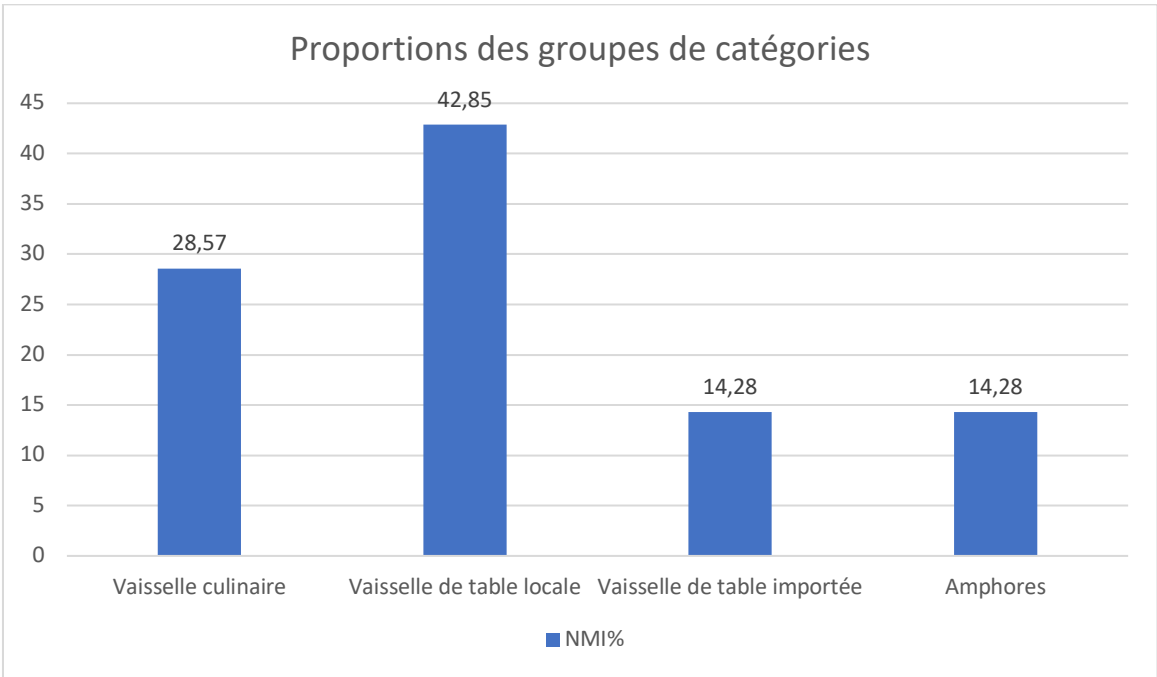
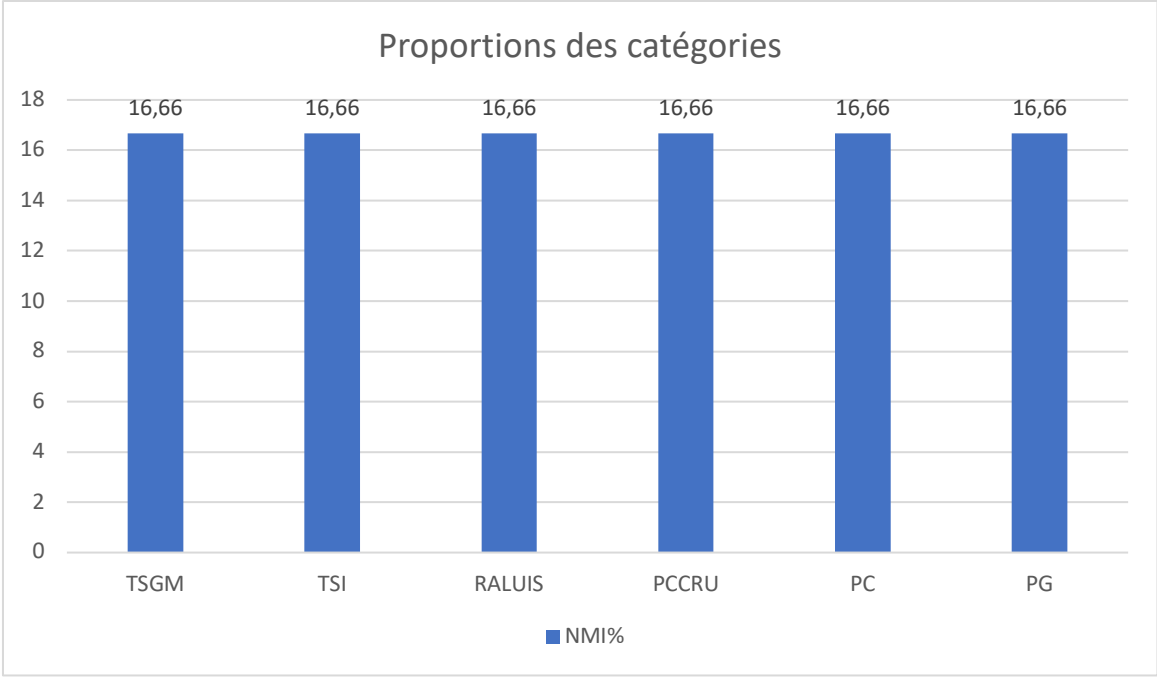
Fig. 68: Local 8: séjour ?

NMI	Catégories	%
1	TSGM	16,66
1	TSI	16,66
1	RALUIS	16,66
1	PCCRU	16,66
1	PC	16,66
1	PG	16,66
6		100%

NMI	Catégories	%
2	Vaisselle culinaire	28,57
3	Vaisselle de table locale	42,85
1	Vaisselle de table importée	14,28
1	Amphores	14,28
7		100%

NMI	Formes	%
1	Bols	25
1	Mortiers	25
1	Gobelets	25
1	Cruches	25
4		100%

NMI	Fonctions	%
1	Consommation liquide individuel	20
0	Consommation solide+ semi-liquide ind.	0
1	Service liquide commun/stockage	20
0	Service solide+semi-liquide commun	0
2	Préparation	40
0	Cuisson	0
0	Stockage	0
0	Fermeture	0
1	Transport	20
5		100%



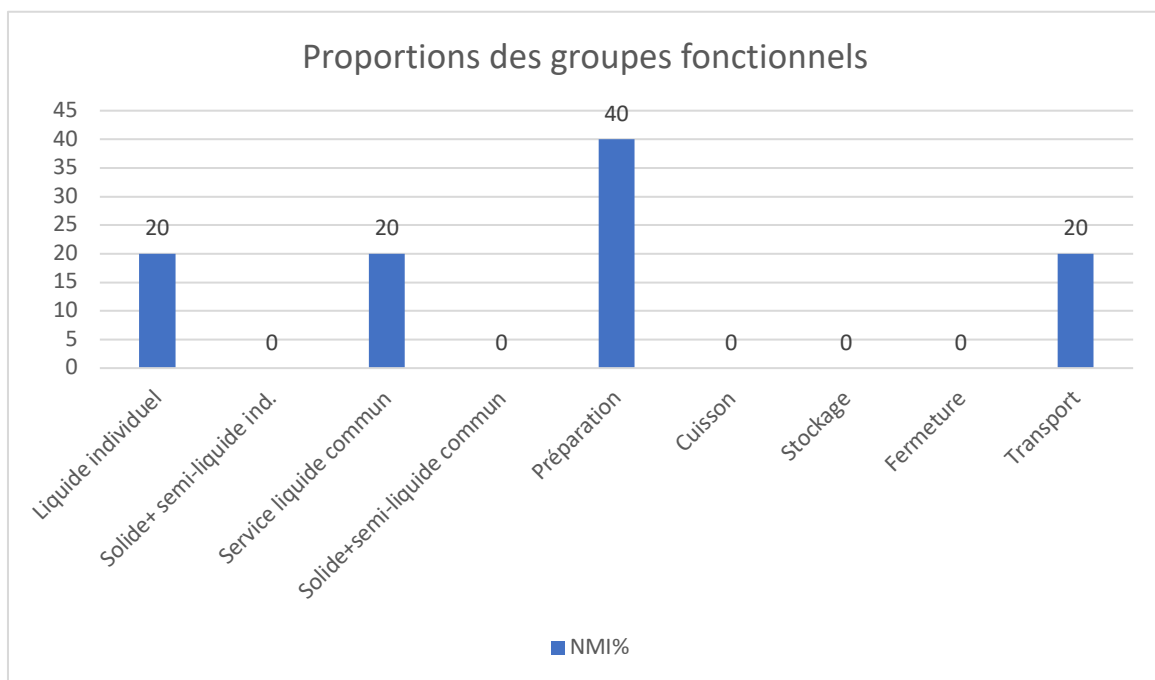
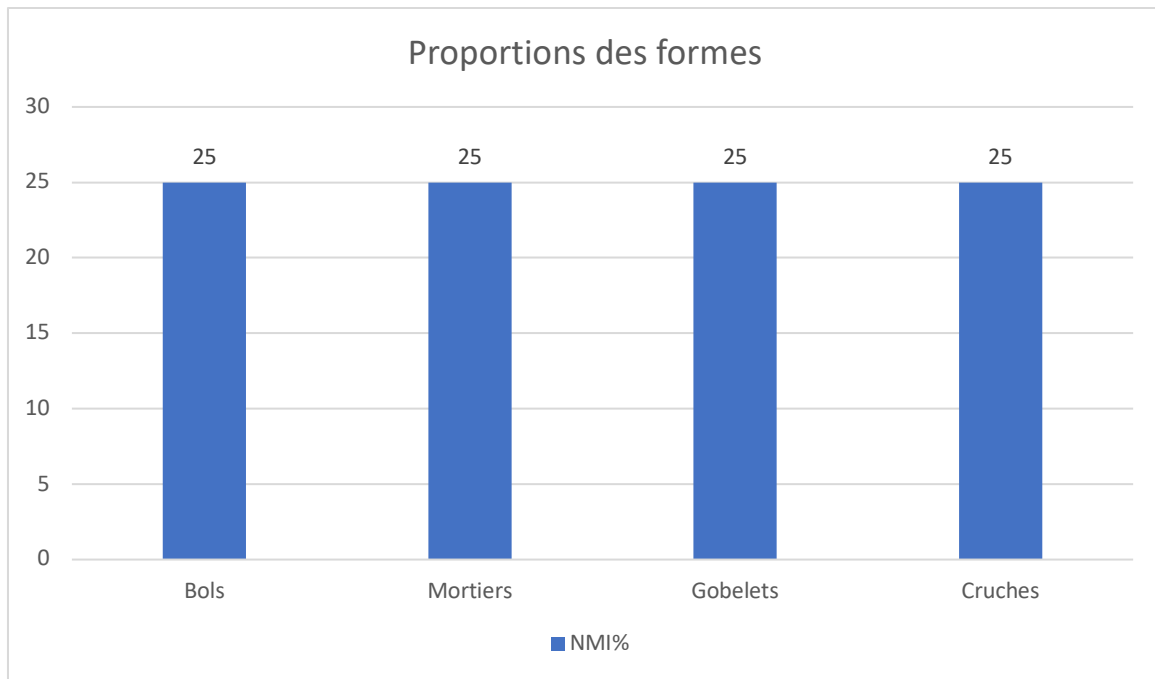


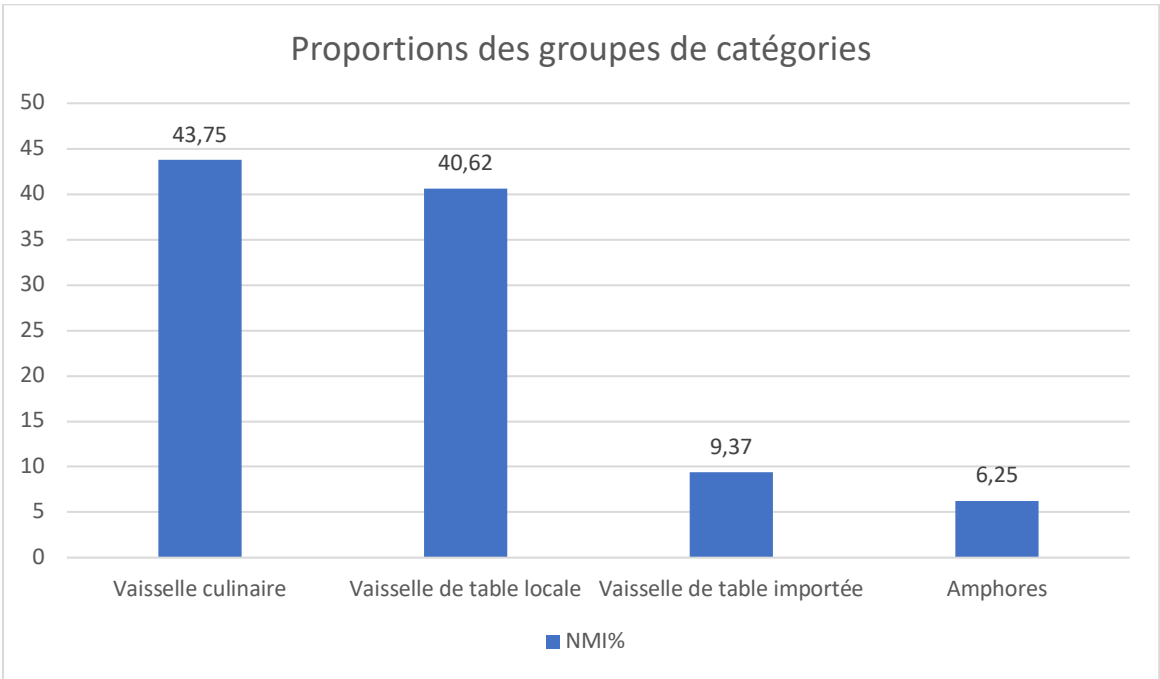
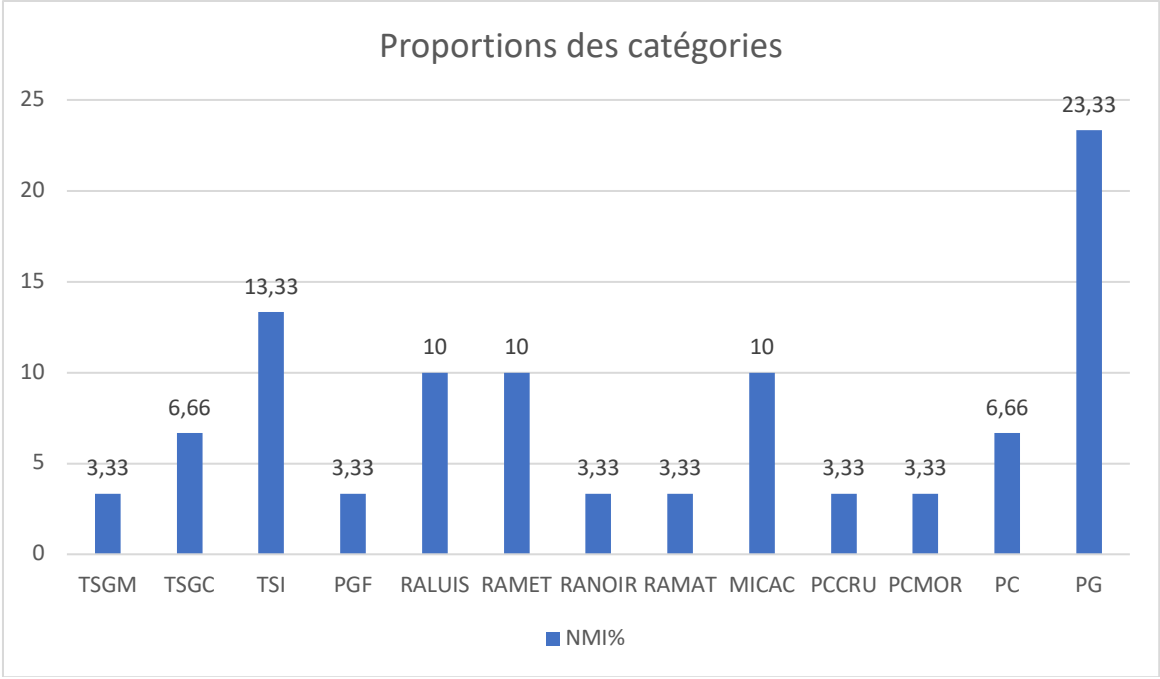
Fig. 69: Local 9: indéterminé (domestique ?).

NMI	Catégories	%
1	TSGM	3,33
2	TSGC	6,66
4	TSI	13,33
1	PGF	3,33
3	RALUIS	10
3	RAMET	10
1	RANOIR	3,33
1	RAMAT	3,33
3	MICAC	10
1	PCCRU	3,33
1	PCMOR	3,33
2	PC	6,66
7	PG	23,33
30		100%

NMI	Catégories	%
14	Vaisselle culinaire	43,75
13	Vaisselle de table locale	40,62
3	Vaisselle de table importée	9,37
2	Amphores	6,25
32		100%

NMI	Formes	%
1	Assiettes	3,44
7	Ecuelles	24,13
2	Coupes	6,89
4	Bols	13,79
1	Bols à colerette	3,44
2	Bols à marli	6,89
2	Mortiers	6,89
6	Gobelets	20,68
2	Pots	6,89
1	Tonneaux	3,44
1	Cruches	3,44
29		100%

NMI	Fonctions	%
6	Consommation liquide individuel	20,68
10	Consommation solide+ semi-liquide ind.	34,48
2	Service liquide commun/stockage	6,89
3	Service solide+semi-liquide commun	10,34
2	Préparation	6,89
2	Cuisson	6,89
2	Stockage	6,89
0	Fermeture	0
2	Transport	6,89
29		100%



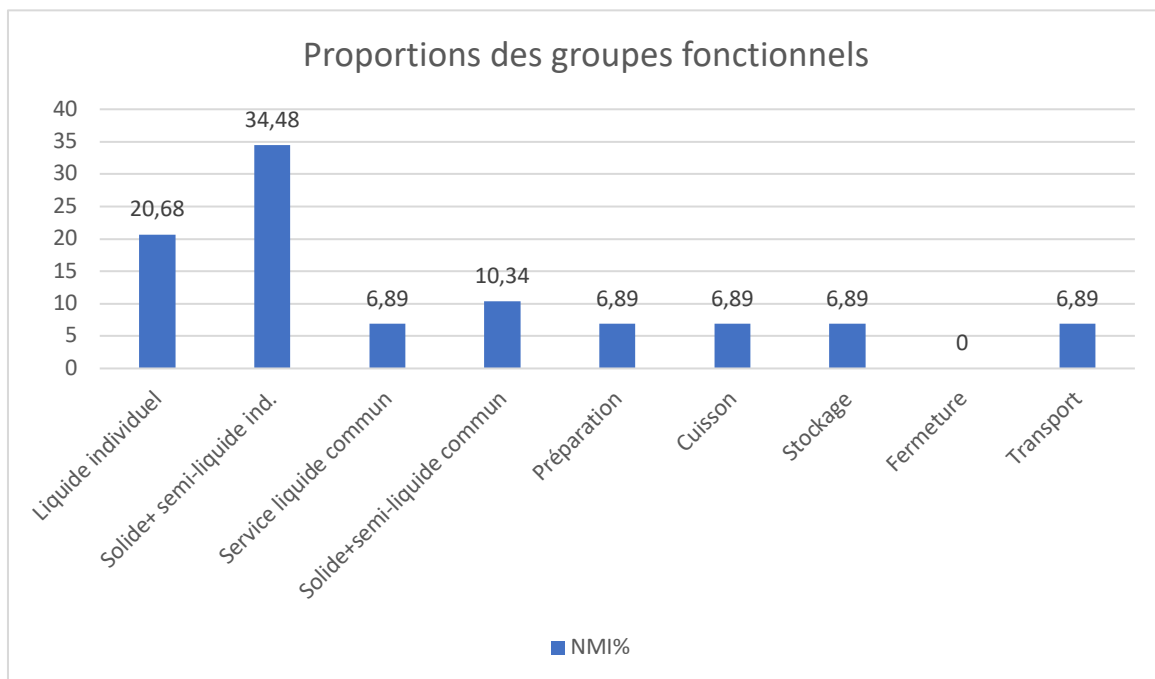
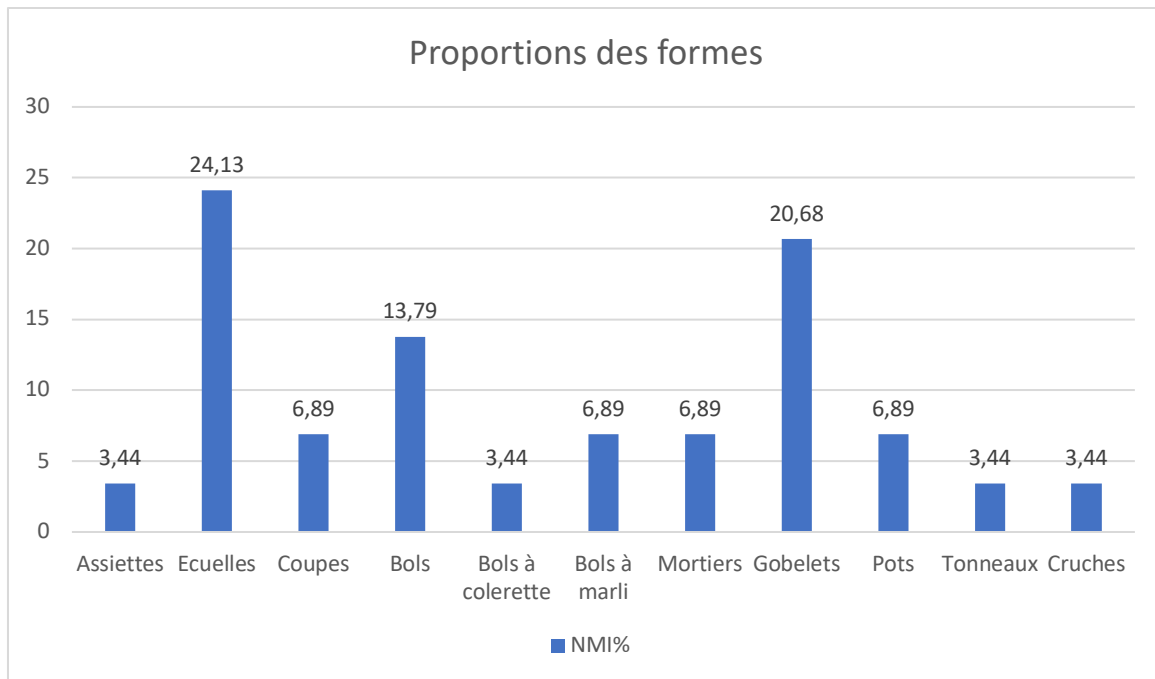


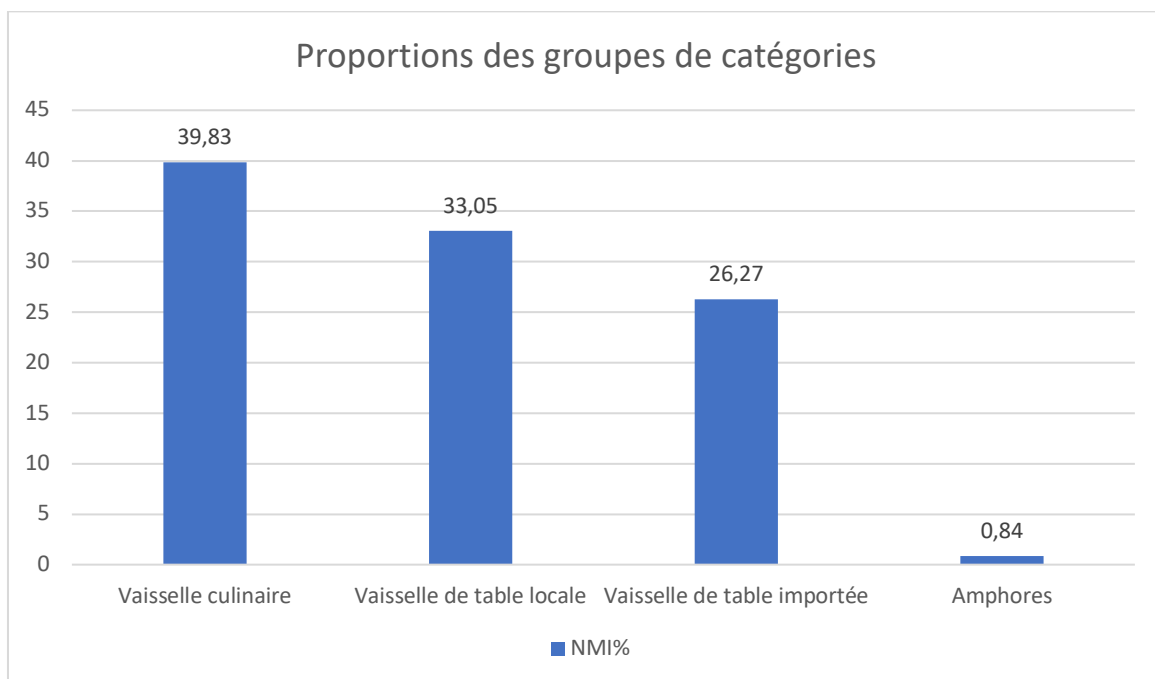
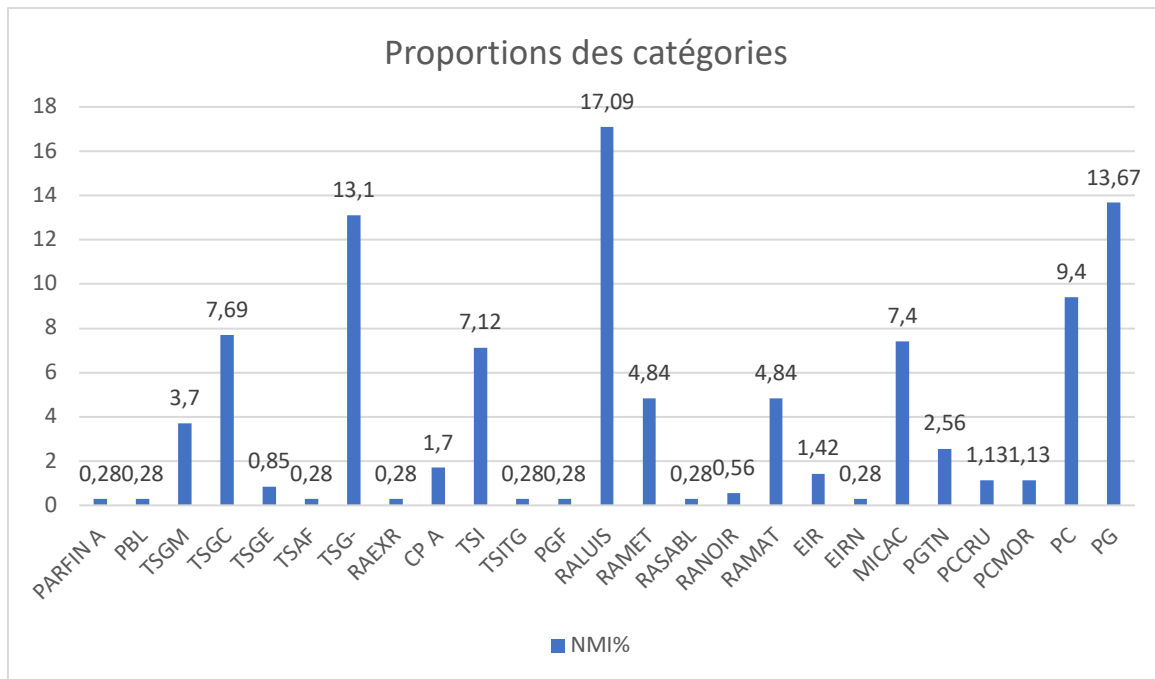
Fig. 70: Local 11: séjour.

NMI	Catégories	%
1	PARFIN A	0,28
1	PBL	0,28
13	TSGM	3,7
27	TSGC	7,69
3	TSGE	0,85
1	TSAF	0,28
46	TSG-	13,1
1	RAEXR	0,28
6	CP A	1,7
25	TSI	7,12
1	TSITG	0,28
1	PGF	0,28
60	RALUIS	17,09
17	RAMET	4,84
1	RASABL	0,28
2	RANOIR	0,56
17	RAMAT	4,84
5	EIR	1,42
1	EIRN	0,28
26	MICAC	7,4
9	PGTN	2,56
4	PCCRU	1,13
4	PCMOR	1,13
33	PC	9,4
48	PG	13,67
351		100%

NMI	Catégories	%
141	Vaisselle culinaire	39,83
117	Vaisselle de table locale	33,05
93	Vaisselle de table importée	26,27
3	Amphores	0,84
354		100%

NMI	Formes	%
29	Assiettes	8,28
8	Plats	2,28
43	Ecuelles	12,28
1	Marmites	0,28
27	Coupes	7,71
1	Calices	0,28
81	Bols	23,14
14	Bols à marli	4
8	Mortiers	2,28
56	Gobelets	16
48	Pots	13,71
2	Pots à prov.	0,57
3	<i>Dolia</i>	0,85
14	Tonneaux	4
1	Bouteilles	0,28
7	Cruches	2
6	Couvercles	1,71
1	Jetons	0,28
350		100%

NMI	Fonctions	%
61	Consommation liquide individuel	16,94
55	Consommation solide+ semi-liquide ind.	15,27
22	Service liquide commun/stockage	6,11
132	Service solide+semi-liquide commun	36,66
12	Préparation	3,33
26	Cuisson	7,22
42	Stockage	11,66
7	Fermeture	1,94
3	Transport	0,83
360		100%



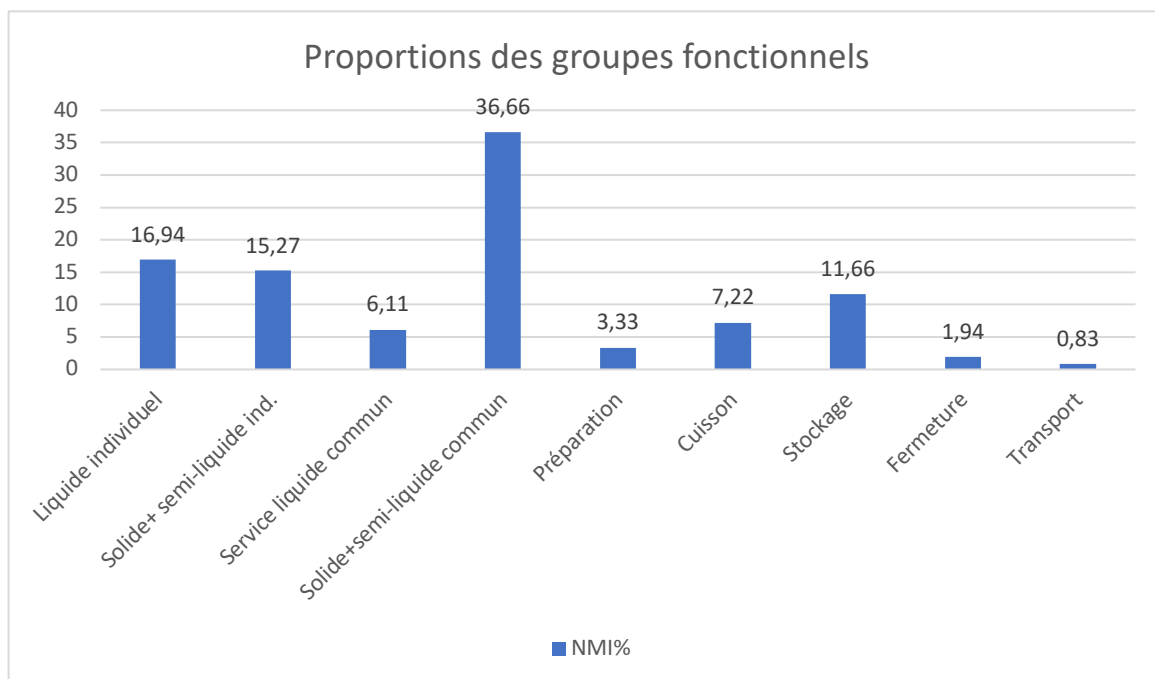
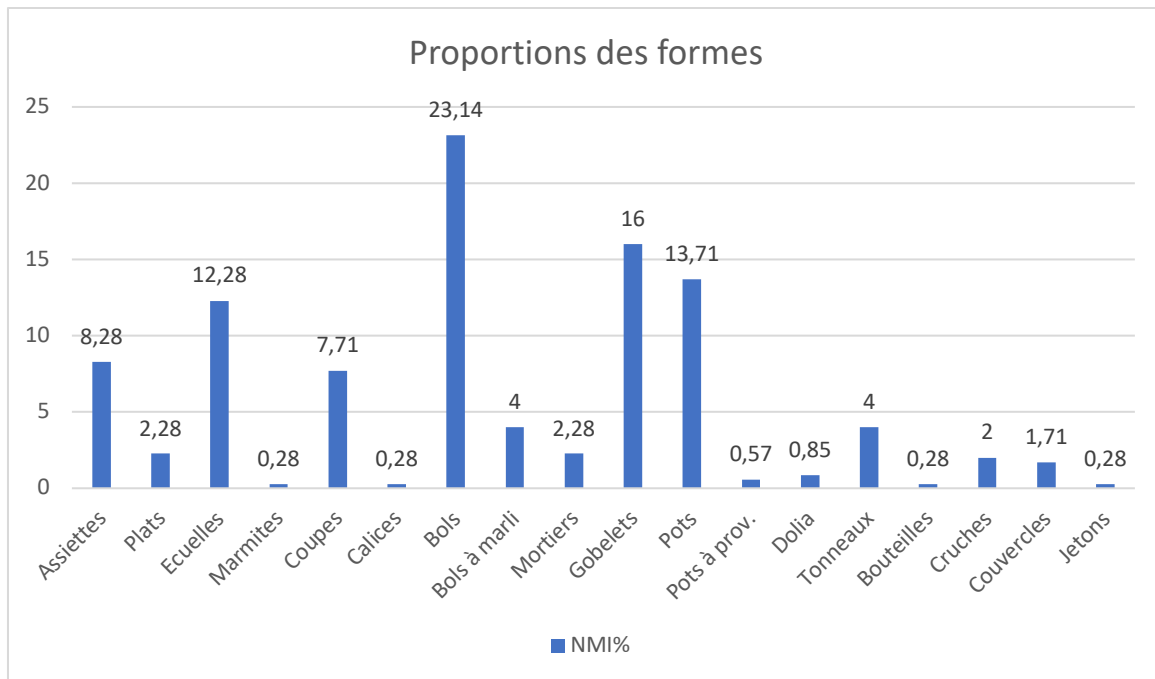
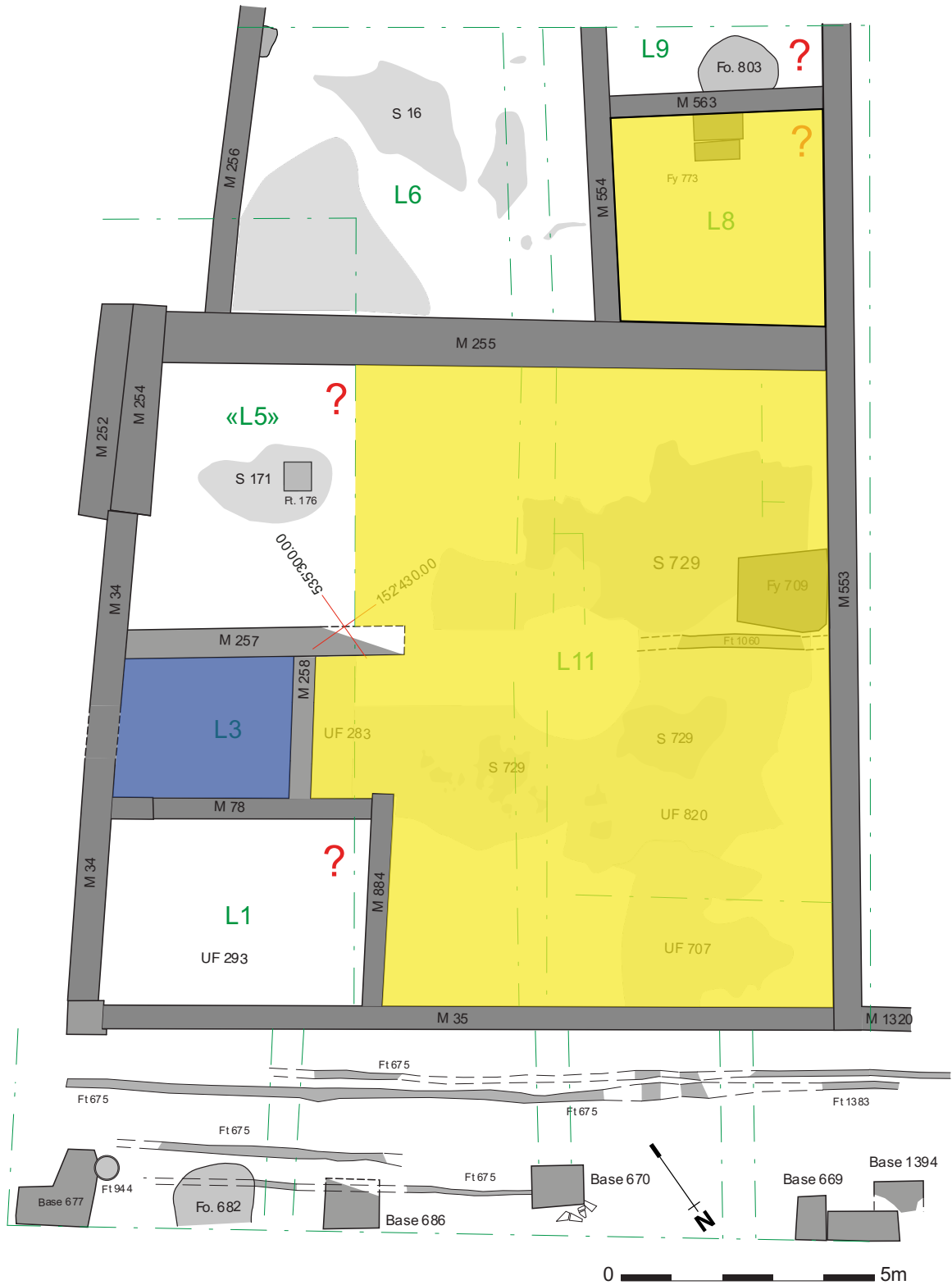


Fig. 71: Proposition d'attribution fonctionnelle des locaux de la période C-3.



- Séjour (domestique)
- Stockage
- Cour

4.3. Conclusions, limites et synthèse de l'approche

Fig. 72: Critères d'identification des espaces par leurs aménagements et leur mobilier céramique.

Pièce de séjour (domestique)	Cuisine (domestique)	Atelier artisanal (culinaire)	Atelier artisanal (forge)	Boutique, échoppe	Espaces de stockage
Foyer isolé (contre une paroi ou décentré)	Foyer central (avec potence)	Foyer lié à une production	Foyer lié à une production	Equipement non significatif	Equipement non significatif
Décors soignés (enduits peints, sol en béton)	Couche d'occupation importante	Sol peu aménagé	Sol peu aménagé	Localisation à l'avant des bâtiments	Pièce de taille réduite ou grande halle
Forme de la pièce		Structures spécialisées	Structures spécialisées		Localisation
					Aménagements liés au rangement/conservation (étagères, amphores)
					Cave ou cellier
Majorité de céramique culinaire	Majorité de céramique culinaire, suivie de près par les vaisselles de table locale et importée	Majorité de céramique culinaire, suivie de près par les vaisselles de table locale et importée	Majorité de céramique culinaire, suivie de près par les vaisselles de table locale et importée	Majorité de céramique culinaire, suivie de près par les vaisselles de table locale et importée	Majorité de céramique culinaire (faible NMI toutefois)
Majorité d'assiettes, d'écuelles, de coupes, gobelets et bols	Majorité d'assiettes, bols, marmites, de pots de cuisson	Majorité de bols, coupes et pots	Majorité d'assiettes, bols, pots et couvercles	Majorité d'assiettes, coupes, bols et pots. Cruches et amphores, parfois bien représentées	Majorité de pots de stockage, de <i>dolia</i>
Consommation et service de denrées solides et semi-liquides, consommation et stockage de liquides	Consommation et service de denrées solides et semi-liquides, cuisson	Consommation et service de denrées solides et semi-liquides, stockage	Service commun de denrées solides et semi-liquides, consommation individuelle de denrées solides et semi-liquides, fermeture	Consommation et service de denrées solides et semi-liquides, stockage	Stockage

Catalogue

Période G, (20 à 20/10 av. J.-C.), planche 1.1.....	268-269
Période F, (15-30/40 ap. J.-C.), planches 2.1-2.2	270-273
Période E-1, (50 ap. J.-C.), planches 3.1-3.2.....	274-277
Période E-2, (50 à 80/90 (?) ap. J.-C.), planches 4.1-4.2.....	278-281
Période D-1, (100/150 ap. J.-C.), planches 5.1-5.6	282-293
Période D-2, (150/180 ap. J.-C.), planches 6.1-6.5.....	294-303
Période D-3, (180 ap. J.-C.), planches 7.1-7.8	304-319
Période C-1, (180 ap. J.-C.), planches 8.1-8.7.....	320-333
Période C-2, (180/200 ap. J.-C.), planches 9.1-9.11	334-355
Période C-3, (274 ap. J.-C.), planches 10.1-10.7	356-369
Période B, (330 ap. J.-C.), planches 11.1-11.4	370-377

Vidy-Boulodrome, B2, Période G, (20 à 20/10 av. J.-C.), planche 1.1

Fines régionales oxydées

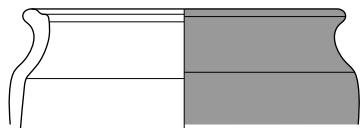
1. CPB. Pot Paunier 1.
Inventaire VB19.3146.02.

Communes régionales oxydées

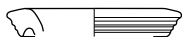
2. PCCRU. Cruche, LS CRU Cr.2.6.a.
Inventaire VB18.2848.01.
3. PC. Écuelle/jatte LS PC E.2.3.b.
Inventaire VB19.3146.03.

Communes régionales réduites

4. PG. Tonneau/tonnelet LS PG T.1.1.a.
Inventaire VB18.2843.04.
5. PG. Couvercle LS PG Cv.3.2.a.
Inventaire VB19.3146.04.



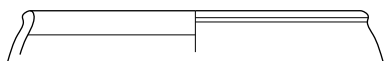
1



2



3



4



5

0 5cm

Echelle 1/3
Dessin et numérisation :
M. Sacchetto

Vidy-Boulodrome, B2, Période F, (15-30/40 ap. J.-C.), planche 2.1

Communes importées, plats à engobe interne d'origine italique

1. EIRP. Plat AV 272.
Inventaire VB19.2683.02.

Fines régionales, imitations de sigillée

2. TSI. Assiette imit. Ha. 1b, L1a.
Inventaire VB18.2767.09.
3. TSI. Assiette imit. Ha. 2/Drag. 17a, L2.
Inventaire VB18.2767.09.
4. TSI. Assiette imit. Drag. 15/17, L7a.
Inventaire VB19.2683.05.

Fines régionales, grises fines

5. PGF. Bol LS PG B.3.1 (vase bobine).
Inventaire VB18.2767.04.

Communes régionales engobées ou lissées

6. EIR. Plat LS EIR A.2.5.
Inventaire VB19.2683.03.

Communes régionales oxydées

7. PCCRU. Cruche LS CRU Cr.2.6.a.
Inventaire VB18.2767.05.
8. PC. Pot à provision LS PC P.1.10.a.
Inventaire VB19.3184.02.
9. PC. Pot à provision LS PC P.1.10.c.
Inventaire VB19.2683.06.



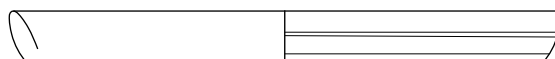
1



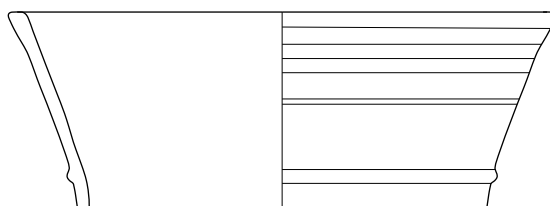
2



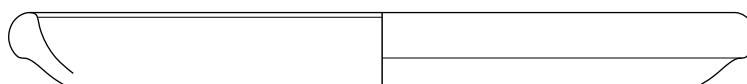
3



4



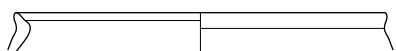
5



6



7



8



9

0 5cm

Echelle 1/3

Dessin et numérisation :

M. Sacchetto

Vidy-Boulodrome, B2, Période F, (15-30/40 ap. J.-C.), planche 2.2

Communes régionales réduites

10. PG. Pot LS PG P.1.2.a.

Inventaire VB18.2767.07.

11. PG. Pot LS PG P.1.3.a.

Inventaire VB19.2683.04.

12. PG. Pot. LS PG P.3.2.

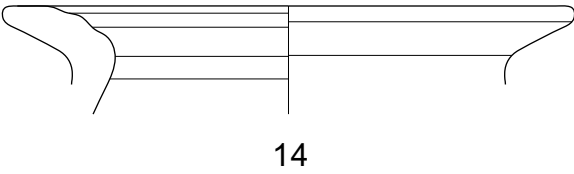
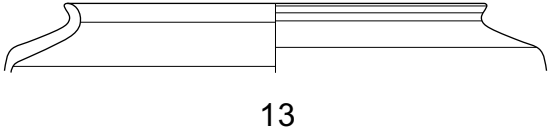
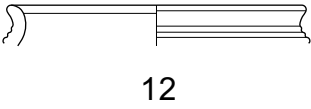
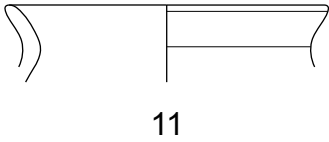
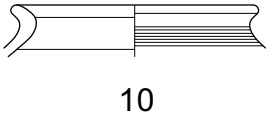
Inventaire VB18.2767.10.

13. PG. Pot LS PG 3.7.b.

Inventaire VB18.2767.11.

14. PG. Dolium LS PG D.1.1.b.

Inventaire VB18.2767.06.



0 5cm

Echelle 1/3
Dessin et numérisation :
M. Sacchetto

Vidy-Boulodrome, B2, Période E-1, (50 ap. J.-C.), planche 3.1

Fines importées, terres sigillées

1. TSIT. Coupe indéterminée.

Estampille : XANTI.

Inventaire VB19.2981.01.

2. TSGC. Coupe Drag. 4/22.

Inventaire VB19.2981.05.

Fines régionales, imitations de sigillée

3. TSI. Assiette imit. Ha. 2/Drag. 17a, L2.

Inventaire VB19.2981.03.

Communes régionales engobées ou lissées

4. EIR. Plat LS EIR A.1.1.a.

Inventaire VB19.2981.06.

Communes régionales oxydées

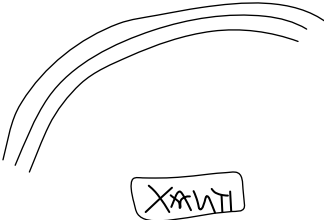
5. PCCRU. Cruche LS CRU Cr.1.2.

Inventaire VB19.2981.10.

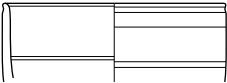
Communes régionales réduites

6. PG. Pot LS PG P.1.1.b.

Inventaire VB19.2981.09.



1 (Estampille à échelle 1:1)



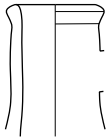
2



3



4



5



6

0 5cm

Echelle 1/3
Dessin et numérisation :
M. Sacchetto

Vidy-Boulodrome, B2, Période E-1, (50 ap. J.-C.), planche 3.2

Communes régionales réduites (suite)

7. PG. Pot LS PG P.1.3.a.

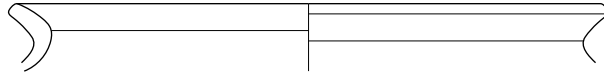
Inventaire VB19.2981.08.

8. PG. Pot LS PG P.3.5.

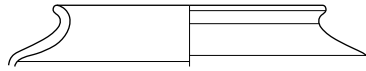
VB19.2981.04.

9. PG. Couvercle LS PG Cv.2.1.

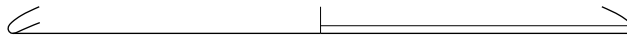
Inventaire VB19.2981.07.



7



8



9

0 5cm

Echelle 1/3
Dessin et numérisation :
M. Sacchetto

**Vidy-Boulodrome, B2, Période E-2, (50 à 80/90 (?) ap. J.-C.),
planche 4.1**

Fines importées, terres sigillées

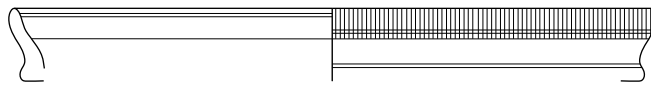
1. TSIT. Assiette Ha. 2.
VB18.2451.08.
2. TSGM. Coupe Drag. 27C.
Inventaire VB18.2451.07.

Fines régionales oxydées

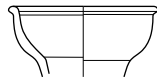
3. CP A. Bol Paunier 11.
Inventaire VB19.2458.07.

Fines régionales, imitations de sigillée

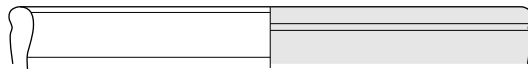
4. TSI. Assiette Ha. 2/Drag. 17a, L2.
Inventaire VB18.2451.11.
5. TSITG. Assiette imit. Drag. 15/17, L7b.
Inventaire VB19.2458.08.
6. TSI. Assiette imit. Ha. 5.
Inventaire VB19.2991.01.
7. TSI. Écuelle/jatte L18.
Inventaire VB19.2458.06.
8. TSI. Bol Drack 21, L40b.
Inventaire VB19.2451.10.
9. TSI. Bol Drack 21, L40c.
Inventaire VB19.2451.09.



1



2



3



4



5



6



7



8



9

0 5cm

Echelle 1/3

Dessin et numérisation :

M. Sacchetto

**Vidy-Boulodrome, B2, Période E-2, (50 à 80/90 (?) ap. J.-C.),
planche 4.2**

Communes régionales engobées ou lissées

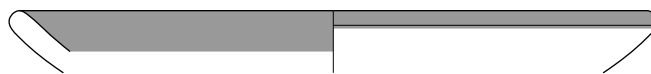
- 10. EIR. LS EIR A.1.1.b.
Inventaire VB19.2458.05.
- 11. PGTN. Pot LS PG P.3.1.
Inventaire VB19.2458.09.

Communes régionales oxydées

- 12. PCCRU. Cruche LS CRU Cr.3.3.a.
Inventaire VB19.2458.04.
- 13. PC. Pot à provision LS PC P.1.10.a.
Inventaire VB19.2458.11.

Communes régionales réduites

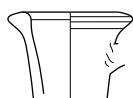
- 14. PG. Écuille/jatte LS PG E.1.5.
Inventaire VB19.2458.10.
- 15. PG. Coupe LS PG C.2.1.
Inventaire VB19.2458.12.
- 16. PG. Pot LS PG P.1.3.b.
Inventaire VB19.2458.03.



10



11



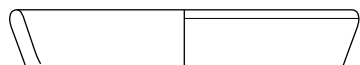
12



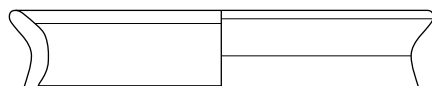
13



14



15



16

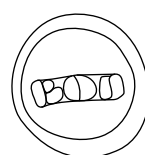
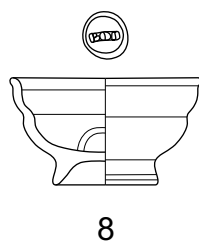
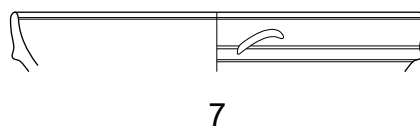
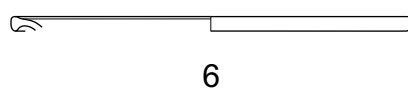
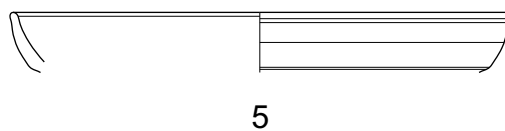
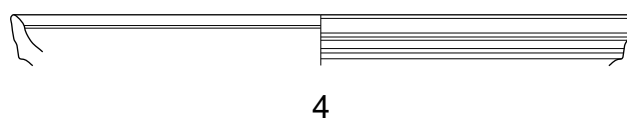
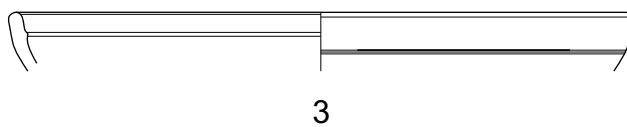
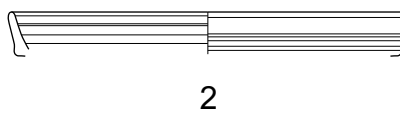
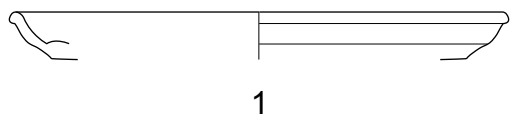
0 5cm

Echelle 1/3
Dessin et numérisation :
M. Sacchetto

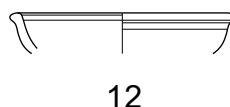
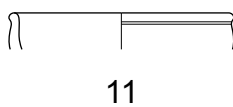
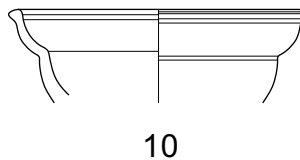
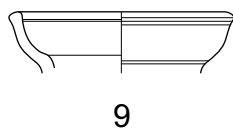
Vidy-Boulodrome, B2, Période D-1, (100/150 ap. J.-C.), planche 5.1

Fines importées, sigillées

1. TSGM. Assiette Drag. 16.
Inventaire VB19.2910.55.
2. TSGM. Assiette Ha. 2/Drag. 17.
Inventaire VB19.2910.98.
3. TSGM. Assiette Drag. 15/17A.
Inventaire VB19.2910.88.
4. TSGM. Assiette Drag. 15/17.
Inventaire VB19.2910.90.
5. TSGM. Assiette Drag. 18B.
Inventaire VB19.2910.93.
6. TSGM. Assiette Curle 15.
Inventaire VB19.2910.94.
7. TSGM. Coupe Drag. 24/25A.
Inventaire VB19.2910.95.
8. TSGM. Coupe Drag. 27b.
Estampille : RON ?
Inventaire VB19.2910.28.
9. TSGM. Coupe Drag. 27C.
Inventaire VB19.2910.97.
10. TSGM. Coupe Drag. 27.
Inventaire VB19.2910.99.
11. TSGM. Coupe Drag. 27.
Inventaire VB19.2910.100.
12. TSGC. Coupe Drag. 27.
Inventaire VB19.2910.101.



(Estampille à échelle 1:1)



0 5cm

Echelle 1/3

Dessin et numérisation :

M. Sacchetto

B. Pagni (1)

Vidy-Boulodrome, B2, Période D-1, (100/150 ap. J.-C.), planche 5.2

Fines importées, sigillées (suite)

13. TSGM. Coupe Drag. 4/22.
Inventaire VB19.2910.89.
14. TSGM. Coupe Ritt. 9.
Inventaire VB19.2910.96.
15. TSGM. Coupe Ritt. 8.
Inventaire VB19.2910.61.
16. TSGM. Bol Drag. 29.
Inventaire VB19.2910.91.
17. TSGM. Bol à collerette Ritt. 12.
Inventaire VB19.2910.92.

Fines importées, parois fines

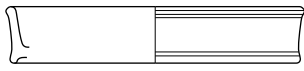
18. PARFIN A. Coupe Bertrand 2.2.
Inventaire VB19.2910.86.
19. PARFIN A. Coupe Bertrand 4.1.1.
Inventaire VB19.2910.87.

Fines régionales oxydées

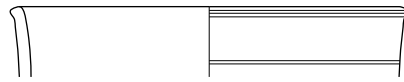
20. CP A. Bol Paunier 11.
Inventaire VB19.2910.131.

Fines régionales, imitations de sigillée

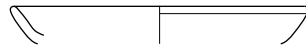
21. TSI. Assiette Drack 4, L4a.
Inventaire VB19.2910.112.
22. TSI. Assiette Drack 4, L4.
Inventaire VB19.2910.104.



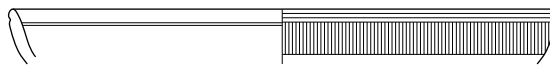
13



14



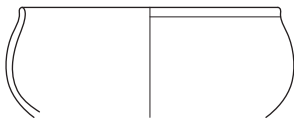
15



16



17



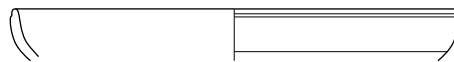
18



19



20



21



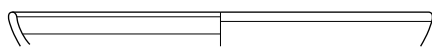
22

0 5cm

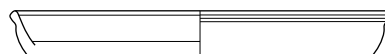
Vidy-Boulodrome, B2, Période D-1, (100/150 ap. J.-C.), planche 5.3

Fines régionales, imitations de sigillée (suite)

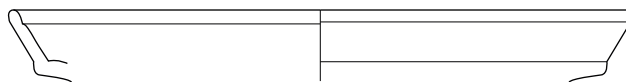
23. TSI. Assiette Drack 4.
Inventaire VB19.2910.110.
24. TSI. Assiette imit. Drag. 18, L6.
Inventaire VB19.2910.106.
25. TSI. Assiette imit. Drag 15/17, L7b.
Inventaire VB19.2910.54.
26. TSI. Assiette imit. Drag. 15/17, L7.
Inventaire VB19.2910.109.
27. TSI. Assiette imit. Drag. 36, L11.
Inventaire VB19.2910.111.
28. TSI. Coupe imit. Ha 8./Hof. 5, L23.
Inventaire VB19.2910.56.
29. TSI. Coupe imit. Drag. 24/25, L29a.
Inventaire VB19.2910.105.
30. TSI. Bol Drack 21, L40c.
Inventaire VB19.2910.29
31. TSI. Bol Drack 21, L40c.
Inventaire VB19.2910.84.
32. TSI. Bol Drack 21, L40c.
Inventaire VB19.2910.113.
33. TSI. Bol Drack 21, L40c.
Inventaire VB19.2910.114.
34. TSI. Bol Drack 21, L40c.
Inventaire VB19.2910.115.
35. TSI. Bol Drack 21, L40c.
Inventaire VB19.2910.116.
36. TSI. Bol Drack 21, L40c.
Inventaire VB19.2910.117.



23



24



25



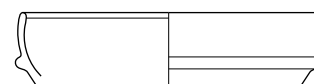
26



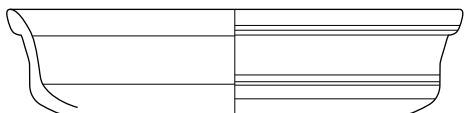
27



28



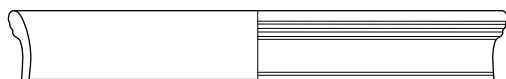
29



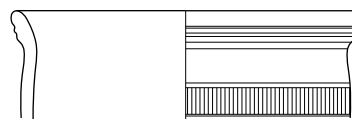
30



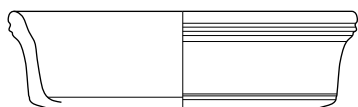
31



32



33



34



35



36

0 5cm

Echelle 1/3

Dessin et numérisation :

M. Sacchetto

B. Pagni (25,30)

Vidy-Boulodrome, B2, Période D-1, (100/150 ap. J.-C.), planche 5.4

Fines régionales, imitations de sigillée (suite)

- 37. TSI. Bol Drack 21, L40d.
Inventaire VB19.2910.53.
- 38. TSI. Bol Drack 21, L40d.
Inventaire VB19.2910.102.
- 39. TSI. Bol L47.
Inventaire VB19.2910.107.
- 40. TSI. Bol L50a.
Inventaire VB19.2910.108.

Fines régionales, grises fines

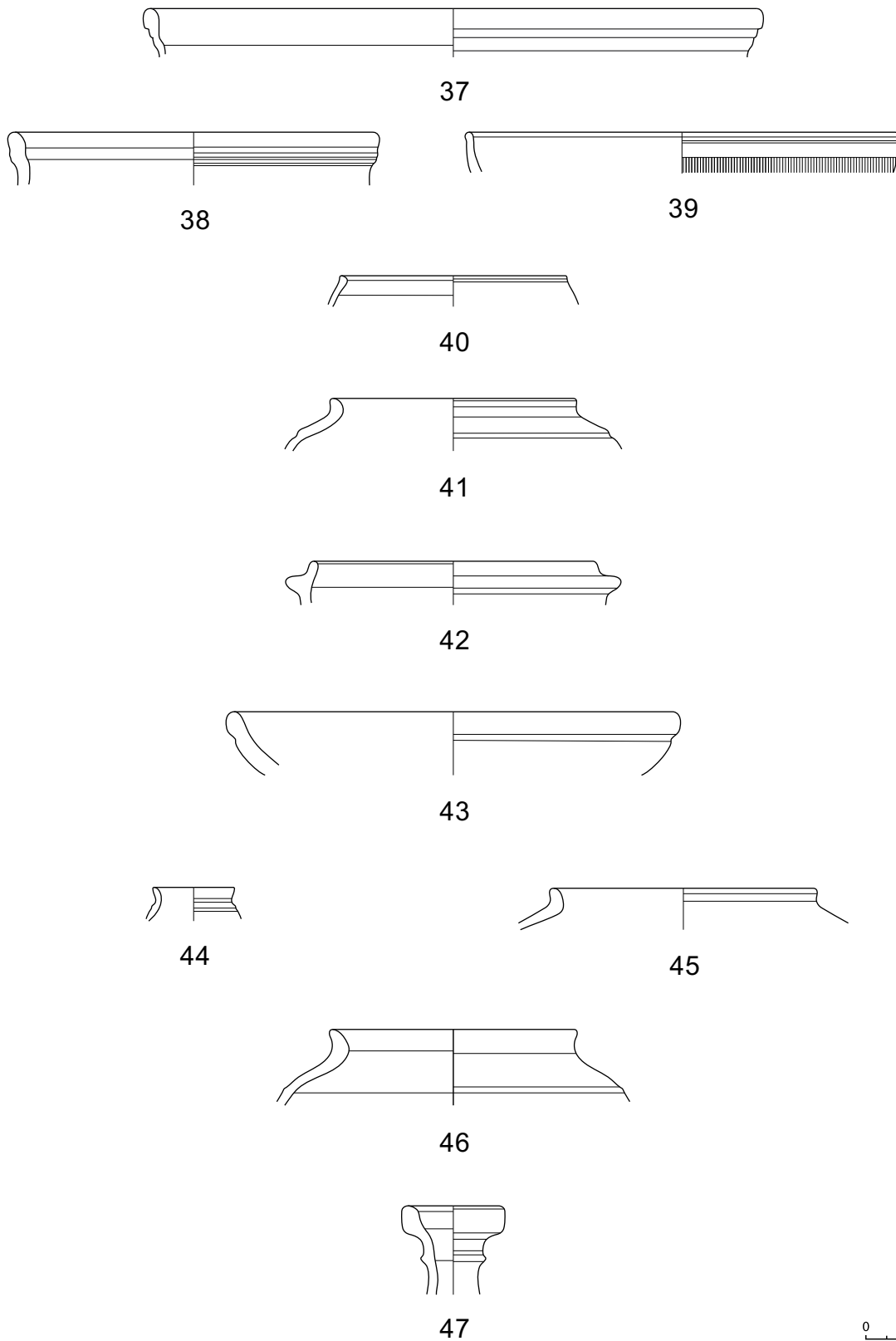
- 41. PGF. Pot LS PG P.3.7.
Inventaire VB19.2910.145.

Communes régionales engobées ou lissées

- 42. MICAC. Bol LS MIC B.2.5.
Inventaire VB19.2910.134.
- 43. EIRN. Plat LS EIR A.2.5. var.
Inventaire VB19.2910.142.
- 44. PGTN. Gobelet LS PG G.1.2.
VB19.2910.141.
- 45. PGTN. Pot LS PG P.3.5.
Inventaire VB19.2910.138.
- 46. PGTN. Pot LS PG P.3.7.a.
Inventaire VB19.2910.136.

Communes regionals oxydées

- 47. PCCRUC. Cruche LS CRU Cr.2.2.a.
Inventaire VB19.2910.135.



Vidy-Boulodrome, B2, Période D-1, (100/150 ap. J.-C.), planche 5.5

Communes regionals oxydées (suite)

48. PCMOR. Mortier LS MOR Mo.3.3.

VB19.2910.140.

49. PC. Pot LS PC P.1.10. approx.

Inventaire. VB19.2910.139.

Communes régionales réduites

50. PG. Écuelle/jatte LS PG E.1.1.

Inventaire VB19.2910.123.

51. PG. Marmite tripode LS PG Ma.1.7.c.

Inventaire VB19.2910.119.

52. PG. Marmite tripode LS PG Ma.1.7.c.

Inventaire VB19.2910.144.

53. PG. Écuelle/jatte LS PG E.2.7.a.

Inventaire VB19.2910.133.

54. PG. Écuelle/jatte LS PG E.2.7.b.

Inventaire VB19.2910.120.

55. PG. Écuelle/jatte LS PG E.5.2.

Inventaire VB19.2910.124.

56. PG. Gobelet LS PG G.1.2.

Inventaire VB19.2910.132.

57. PG. Pot LS PG P.1.2.b.

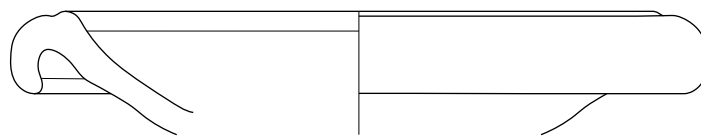
Inventaire VB19.2910.121.

58. PG. Pot LS PG P.1.3.a.

Inventaire VB19.2910.130.

59. PG. Pot LS PG P.1.3.b.

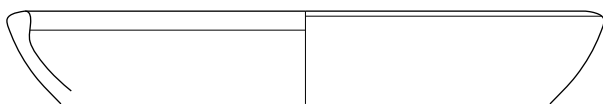
Inventaire VB19.2910.122.



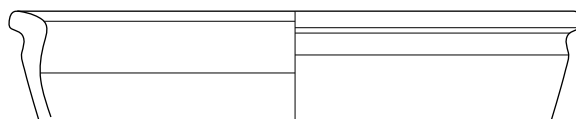
48



49



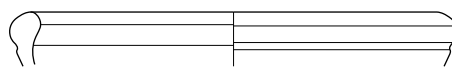
50



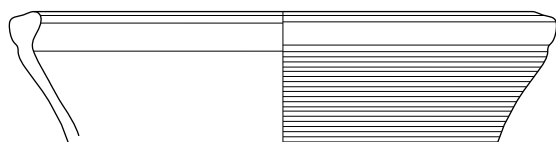
51



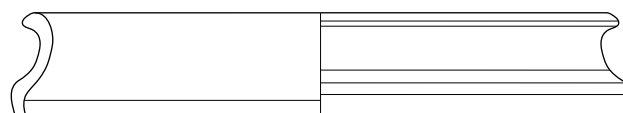
52



53



54



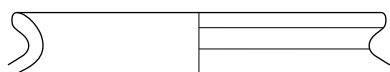
55



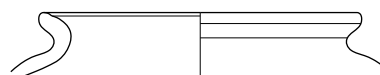
56



57



58



59

0 5cm

Echelle 1/3
Dessin et numérisation :
M. Sacchetto

Vidy-Boulodrome, B2, Période D-1, (100/150 ap. J.-C.), planche 5.6

Communes régionales réduites (suite)

60. PG. Pot LS PG P.3.3.

Inventaire VB19.2910.118.

61. PG. Pot LS PG P.3.4.

Inventaire VB19.2910.127.

62. PG. Pot LS PG P.3.7.a.

Inventaire VB19.2910.125.

63. PG. Pot LS PG P.3.7.a.

Inventaire VB19.2910.129.

64. PG. Couvercle LS PG Cv.1.1.

Inventaire VB19.2910.143.

65. PG. Couvercle LS PG Cv.2.1.

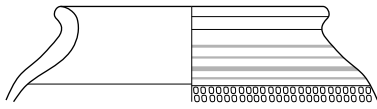
Inventaire VB19.2910.126.

66. PG. Couvercle LS PG Cv.3.1.

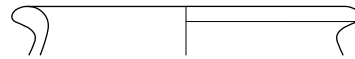
Inventaire VB19.2910.137.

67. PG. Couvercle LS PG Cv.3.2.a.

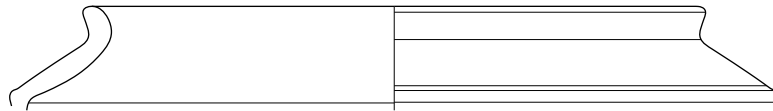
Inventaire VB19.2910.128.



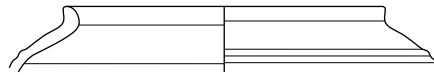
60



61



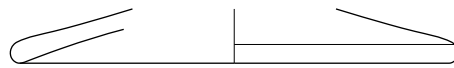
62



63



64



65



66



67

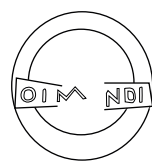
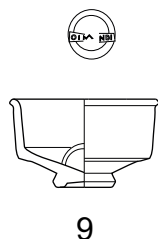
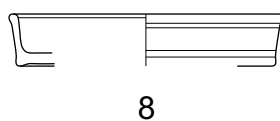
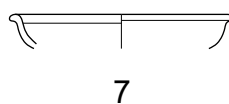
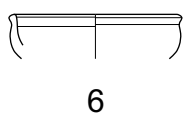
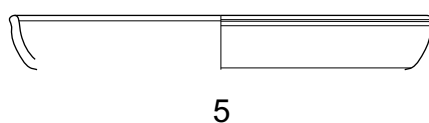
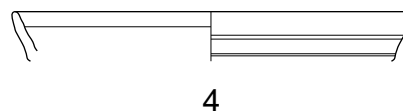
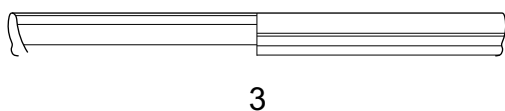
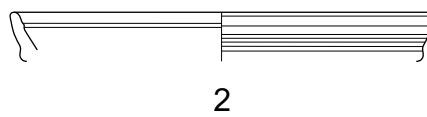
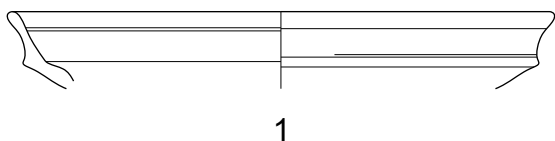
0 5cm

Echelle 1/3
Dessin et numérisation :
M. Sacchetto

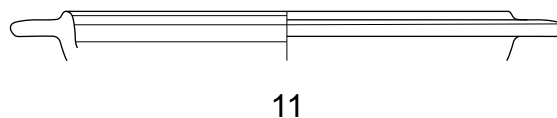
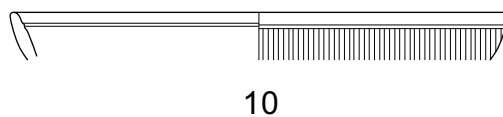
Vidy-Boulodrome, B2, Période D-2, (150/180 ap. J.-C.), planche 6.1

Fines importées, terres sigillées

1. TSGM. Assiette Drag. 15/17A.
VB18.2089.49.
2. TSGM. Assiette Drag. 15/17.
VB18.2089.60.
3. TSGM. Assiette Drag. 15/17.
VB18.2089.77.
4. TSGM. Assiette Drag. 15/17.
VB18.2089.79.
5. TSGM. Assiette Drag. 18.
VB18.2089.63.
6. TSGM. Coupe Drag. 27.
VB18.2089.67.
7. TSGC. Coupe Drag. 27.
VB18.2089.72.
8. TSGM. Coupe Drag. 4/22.
VB18.2089.52.
9. TSGM. Coupe Ritt. 9.
Estampille : OF IV[---]NDI.
VB19.2089.08.
10. TSGM. Bol Drag. 29b.
Inventaire VB18.2089.61.
11. TSGM. Bol à collerette Ritt.12.
Inventaire VB18.2089.73.



(Estampille à échelle 1:1)



0 5cm

Echelle 1/3

Dessin et numérisation :

M. Sacchetto

B. Pagni (9-9a)

Vidy-Boulodrome, B2, Période D-2, (150/180 ap. J.-C.), planche 6.2

Fines importées, parois fines

12. PARFIN A. Coupe Bertrand 5.1.

Inventaire VB18.2089.84.

Fines régionales, imitations de sigillées

13. TSI. Assiette Drack 4, L4.

Inventaire VB19.2089.19.

14. TSI. Assiette Drack 4, L4.

Inventaire VB18.2089.83.

15. TSI. Assiette imit. Drag. 18, L6.

Inventaire VB18.2089.70.

16. TSI. Assiette imit. Drag. 15/17, L7b.

Inventaire VB18.2089.78.

17. TSI. Assiette La Péniche 3, L12.

Inventaire VB18.2089.03.

18. TSI. Assiette imit. Ritt. 14b, L14.

VB19.2089.14.

19. TSI. Coupe imit. Drag. 24/25, L29b.

Inventaire VB18.2089.50.

20. TSI. Coupe imit. Drag. 27, L30.

VB19.2089.16.

21. TSITG. Coupe imit. Drag. 27, L30.

VB18.2089.58.

22. TSI. Bol Drack 21, L40c.

VB18.2089.69.

23. TSI. Bol Drack 21, L40c.

VB18.2089.76.

24. TSI. Bol Drack 21, L40d.

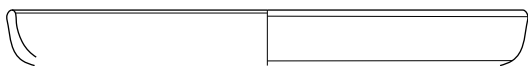
VB18.2089.55.

25. TSI. Bol Drack 21, L40d.

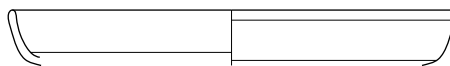
VB18.2089.66.



12



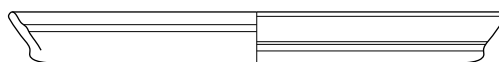
13



14



15



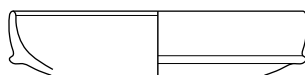
16



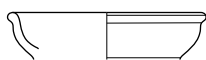
17



18



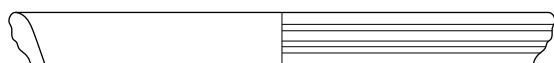
19



20



21



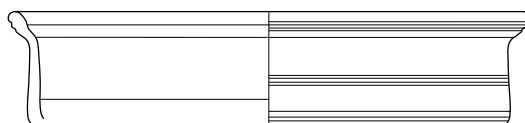
22



23



24



25

0 5cm

Vidy-Boulodrome, B2, Période D-2, (150/180 ap. J.-C.), planche 6.3

Fines régionales, imitations de sigillées (suite)

26. TSI. Tonneau/tonnelet L56a.

VB19.2089.15.

27. TSI. Indéterminé.

Estampille : NA[---].

VB18.2089.34.

Communes régionales engobées ou lissées

28. PGTN. Gobelet cf. AV 11.

Inventaire VB18.2089.75.

Communes régionales oxydées

29. PCCRUC. Cruche LS CRU Cr.1.2.

Inventaire VB19.2089.13.

30. PCCRUC. Cruche AV 321/2 var.

Inventaire VB18.2089.65.

31. PCMOR. Mortier LS MOR Mo.3.3.

Inventaire VB18.2089.04.

32. PC. Couvercle LS PC Cv.2.1.b.

Inventaire VB18.2089.64.

Communes régionales réduites

33. PG. Assiette hors typologie.

VB18.2089.48.

34. PG. Marmite tripode LS PG Ma.1.7.a.

Inventaire VB18.2089.81.

35. PG. Marmite tripode LS PG Ma.1.7.c.

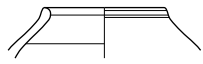
Inventaire VB18.2089.53.

36. PG. Marmite tripode LS PG Ma.1.7.c.

Inventaire VB18.2089.62.

37. PG. Écuëlle/jatte LS PG E.2.6.

Inventaire VB18.2089.80.



26



27 (Estampille à échelle 1:1)



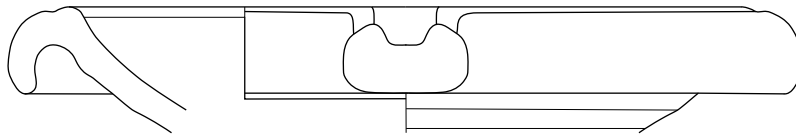
28



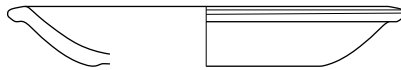
29



30



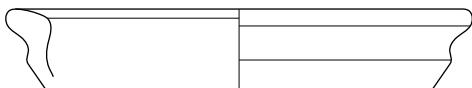
31



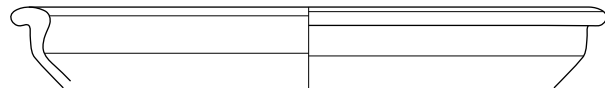
33



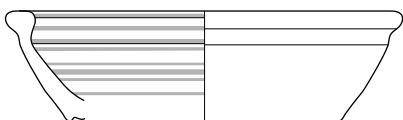
32



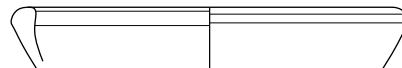
34



35



36



37



Vidy-Boulodrome, B2, Période D-2, (150/180 ap. J.-C.), planche 6.4

Communes régionales réduites (suite)

38. PG. Écuelle/jatte LS PG E.2.7.a.

Inventaire VB18.2089.56.

39. PG. Bol LS PG B.5.2.

Inventaire VB18.2089.68.

40. PG. Gobelet LS PG G.1.2.

Inventaire VB19.2089.18.

41. PG. Pot LS PG P.1.3.b.

Inventaire VB18.2089.71.

42. PG. Pot LS PG P.1.6.

Inventaire VB18.2089.57.

43. PG. Pot LS PG P.2.10.

Inventaire VB18.2089.54.

44. PG. Pot LS PG P.3.5.

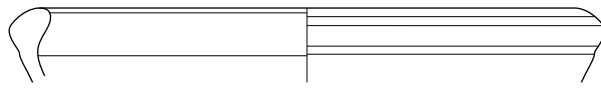
Inventaire VB18.2089.74.

45. PG. Pot LS PG P.3.7.b.

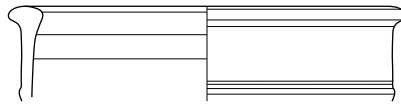
Inventaire VB18.2089.51.

46. PG. Pichet LS PG Pi.2.1.

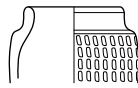
Inventaire VB19.2089.17.



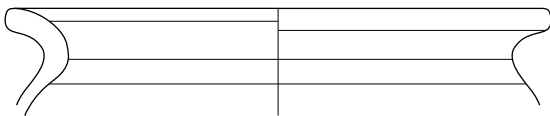
38



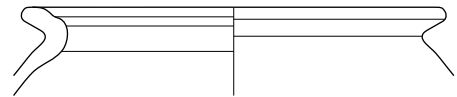
39



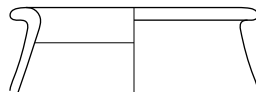
40



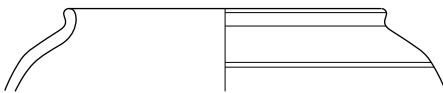
41



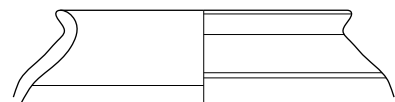
42



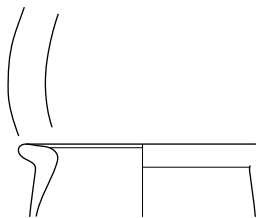
43



44



45



46

0 5cm

Vidy-Boulodrome, B2, Période D-2, (150/180 ap. J.-C.), planche 6.5

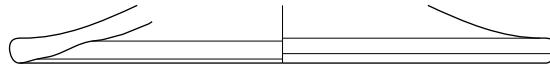
Communes régionales réduites (suite)

47. PG. Couvercle LS PG Cv.3.2.a.

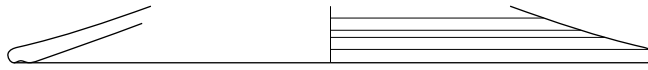
Inventaire VB18.2089.59.

48. PG. Couvercle LS PG Cv.3.2.a.

Inventaire VB18.2089.82.



47



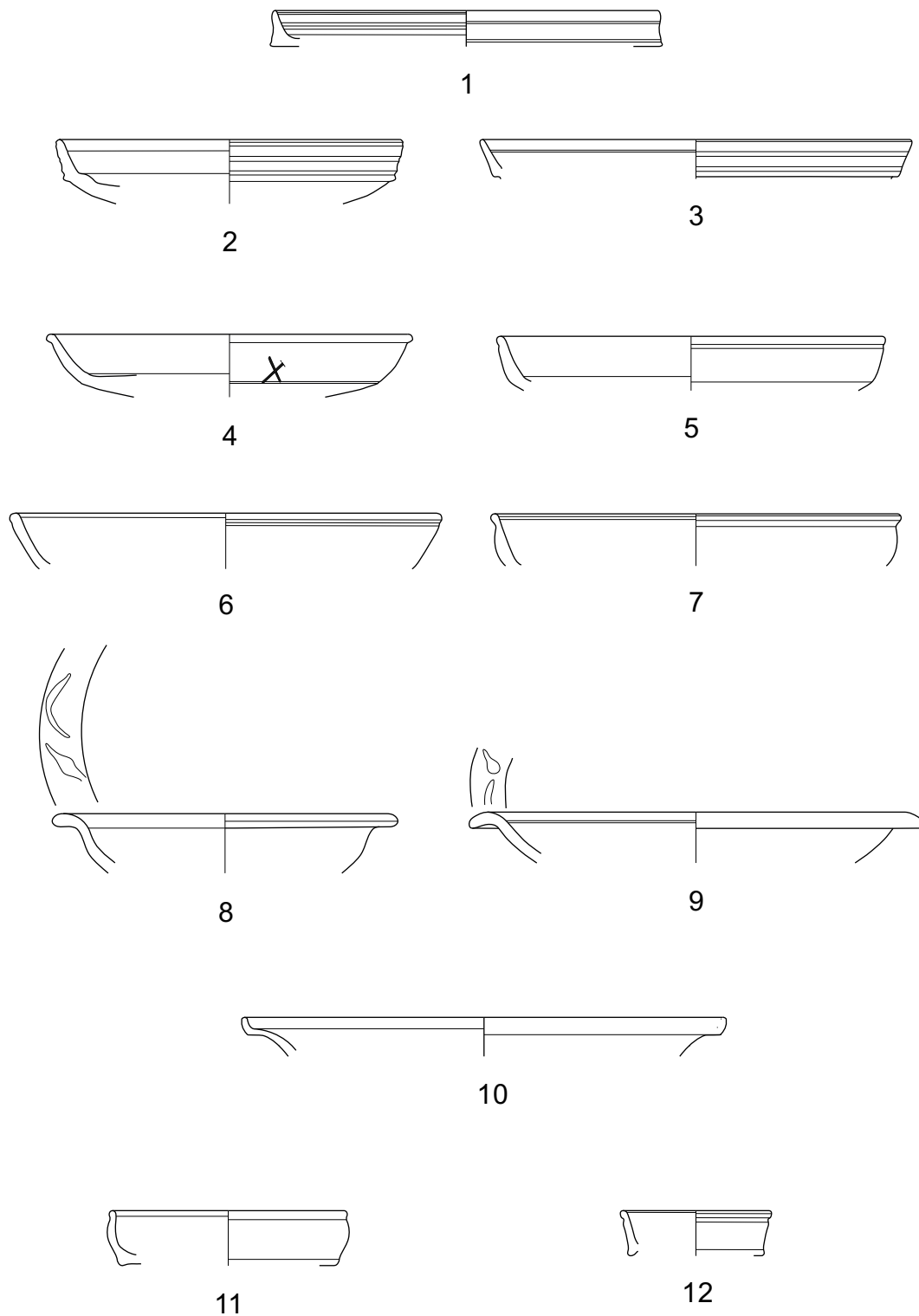
48

0 5cm

Vidy-Boulodrome, B2, Période D-3, (180 ap. J.-C.), planche 7.1

Fines importées, terres sigillées

1. TSIT. Assiette Ha. 2.
Inventaire VB16.1656.24.
2. TSGM. Assiette Drag. 15/17C.
Inventaire VB16.1656.15.
3. TSGM. Assiette Drag. 15/17.
Inventaire VB17.1808.09.
4. TSGM. Assiette Drag. 18B.
Graffito : X[---].
Inventaire VB17.1808.05.
5. TSGM. Assiette Drag. 18.
Inventaire VB16.1656.27.
6. TSGM. Assiette Drag. 18.
Inventaire VB16.1599.29.
7. TSGM. Assiette Drag. 18.
Inventaire VB17.1808.14.
8. TSGM. Assiette Drag. 36.
Inventaire VB16.1656.19.
9. TSGM. Assiette Drag. 36.
Inventaire VB16.1563.21.
10. TSGM. Assiette Curle 15.
Inventaire VB16.1599.16.
11. TSGM. Assiette Herm. 12c.
Inventaire VB16.1563.13.
12. TSGM. Coupe Drag. 4/22.
Inventaire VB16.1599.30.



0 5cm

Echelle 1/3

Dessin et numérisation :

M. Sacchetto

L. Gardon

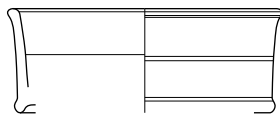
A. Giavina

B. Pagni (2,4,10)

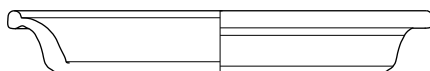
Vidy-Boulodrome, B2, Période D-3, (180 ap. J.-C.), planche 7.2

Fines importées, terres sigillées (suite)

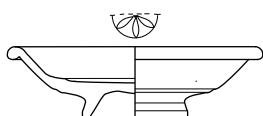
13. TSGM. Coupe Drag. 4/22.
VB17.1808.08.
14. TSGM. Coupe Curle 15.
VB16.1563.14.
15. TSGM. Coupe Curle 23.
Estampille : rosette.
VB16.1656.17.
16. TSGC. Coupe Le 044.
Inventaire VB16.1563.15.
17. TSGM. Bol Drag. 29b.
Inventaire VB17.1808.07.
18. TSGC. Bol Drag. 37 (ansé).
Inventaire VB16.1563.16.
19. TSGM. Bol à collerette Ritt. 12c.
Inventaire VB16.1656.16.
20. TSGM. Indéterminé.
Estampille : MADVILMA.
VB17.1808.04.
21. TSGC. Indéterminé.
Estampille : illisible.
Inventaire VB16.1656.14.



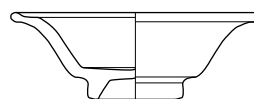
13



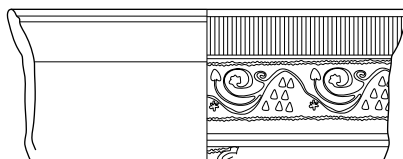
14



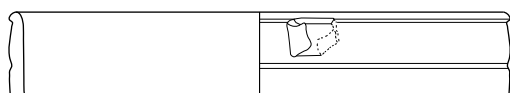
15 (Estampille à échelle 1:1)



16



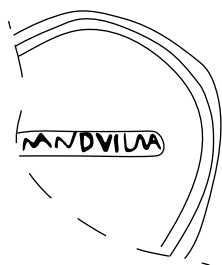
17



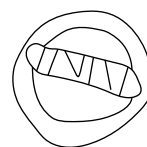
18



19



20



21

(Estampilles à échelle 1:1)

0 5cm

Echelle 1/3

Dessin et numérisation :

M. Sacchetto

L. Gardon

A. Giavina

B. Pagni (14-16, 18-19)

Vidy-Boulodrome, B2, Période D-3, (180 ap. J.-C.), planche 7.3

Communes, plats à engobe interne d'origine italique

22. EIRP. Plat cf. AV 278.

Inventaire VB16.1599.25.

Fines régionales oxydées

23. CP A. Bol Paunier 11.

Inventaire VB16.1599.26.

Fines régionales, imitations de sigillées

24. TSI. Assiette imit. Ha. 2/Drag. 17a, L2.

Inventaire VB18.1808.02.

25. TSI. Assiette imit. Drag. 15/17, L7a.

Inventaire VB17.1808.06.

26. TSI. Assiette imit. Drag. 15/17, L7b.

Inventaire VB16.1656.25.

27. TSI. Assiette Drack 4, L4b.

Inventaire VB16.1599.27.

28. TSITG. Assiette Drack 4, L4.

Inventaire VB17.1656.03.

29. TSI. Assiette imit. Ritt. 14b, L14.

Inventaire VB16.1599.27.

30. TSI. Écuelle/jatte L16.

Inventaire VB16.1563.27.

31. TSI. Coupe imit. Drag. 25/25, L29a.

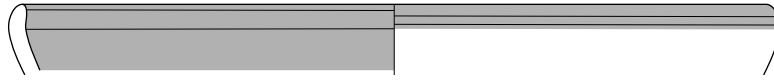
Inventaire VB16.1656.21.

32. TSI. Coupe imit. Drag. 27, L30.

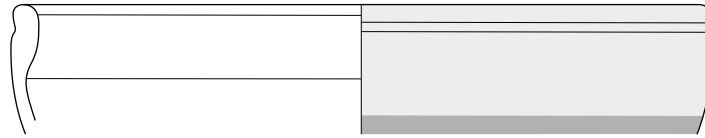
Inventaire VB16.1656.20.

33. TSI. Coupe imit. Drag. 36, L33.

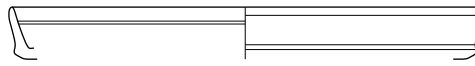
Inventaire VB16.1563.18.



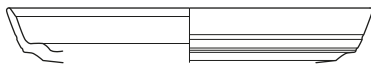
22



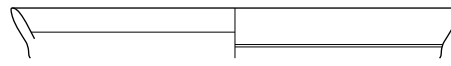
23



24



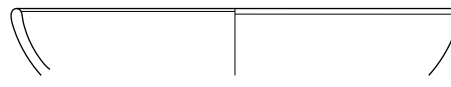
25



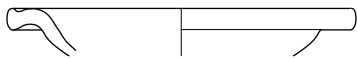
26



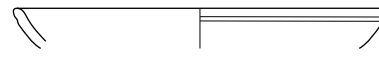
27



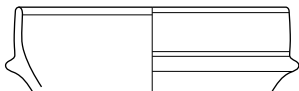
28



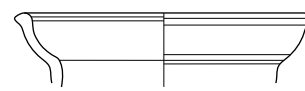
29



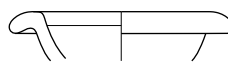
30



31



32



33

0 5cm

Echelle 1/3

Dessin et numérisation :

M. Sacchetto

L. Giardon

A. Giavina (25, 29)

Vidy-Boulodrome, B2, Période D-3, (180 ap. J.-C.), planche 7.4

Fines régionales, imitations de sigillées (suite)

34. TSITG. Bol Drack 20, L39.

Inventaire VB18.1808.03.

35. TSI. Bol Drack 21, L40c.

Inventaire VB16.1563.11.

36. TSI. Bol Drack 21, L40c.

Inventaire VB17.1808.15

37. TSI. Bol Drack 21, L40c.

Inventaire VB16.1656.22.

38. TSI. Bol Drack 21, L40c.

Inventaire VB16.1599.28.

39. TSI. Bol Drack 21, L40c.

Inventaire VB16.1563.19.

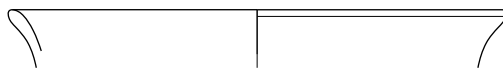
40. TSI. Bol Drack 21, L40d.

Inventaire VB16.1656.23.

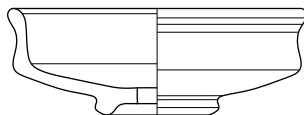
Fines régionales, céramiques à revêtement argileux

41. RAMAT. Bol à marli LS RA B.2.2.

Inventaire VB16.1656.26.



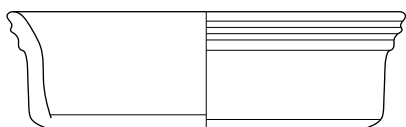
34



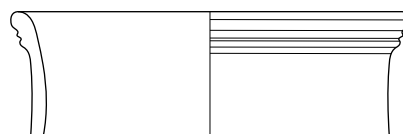
35



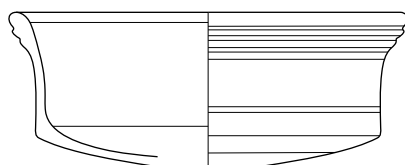
36



37



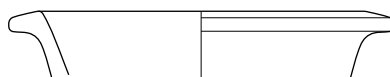
38



39



40



41

0 5cm

Echelle 1/3
Dessin et numérisation :
M. Sacchetto

Vidy-Boulodrome, B2, Période D-3, (180 ap. J.-C.), planche 7.5

Fines régionales, céramiques à revêtement argileux (suite)

42. RAMET. Gobelet LS RA G.2.3.b.

Inventaire VB17.1808.03.

Communes régionales engobées ou lissées

43. MICAC. Couvercle LS MIC Cv.1.1.

Inventaire VB16.1563.26.

44. PGTN. Gobelet LS PG G.1.1.

Inventaire VB17.1808.13.

45. PGTN. Gobelet LS PG G.1.2.

Inventaire VB16.1599.40.

46. PGTN. Pot LS PG P.3.7.b.

Inventaire VB16.1563.24.

47. PGTN. Pot AV 69 var.

Inventaire VB16.1563.20.

Communes régionales oxydées

48. PCCRUC. Cruche LS CRU Cr.1.2.

VB16.1599.31.

49. PC. Couvercle LS PC Cv.2.1.b.

Inventaire VB16.1599.33.

50. PC. Couvercle hors typologie.

Inventaire VB16.1599.32.

Communes régionales réduites

51. PG. Écuelle/jatte LS PG E.1.1.a.

Inventaire VB16.1563.12.

52. PG. Écuelle/jatte LS PG E.1.1.a.

Inventaire VB17.1808.10.

53. PG. Écuelle/jatte LS PG E.1.1.b.

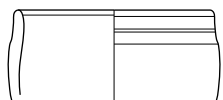
Inventaire VB16.1599.43.



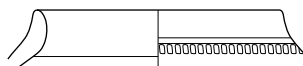
42



43



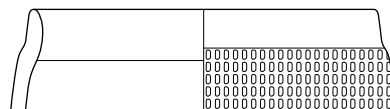
44



45



46



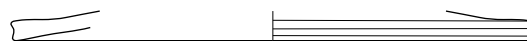
47



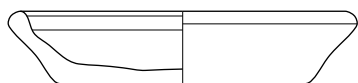
48



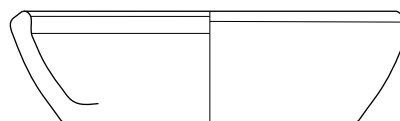
49



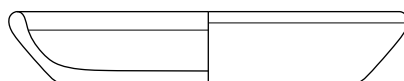
50



51



52



53

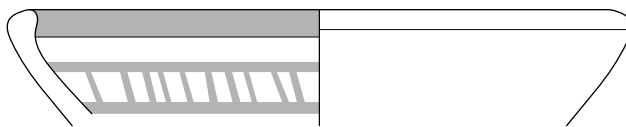
0 5cm

Echelle 1/3
Dessin et numérisation :
M. Sacchetto

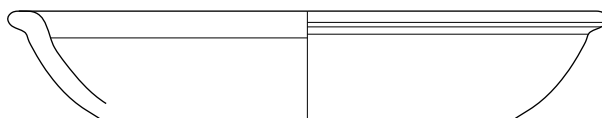
Vidy-Boulodrome, B2, Période D-3, (180 ap. J.-C.), planche 7.6

Communes régionales réduites (suite)

- 54. PG. Écuelle/jatte LS PG E.1.1.
Inventaire VB16.1656.28
- 55. PG. Écuelle/jatte LS PG E.1.6.a.
Inventaire VB16.1599.42.
- 56. PG. Marmite tripode LS PG Ma.1.7.c.
Inventaire VB17.1801.11.
- 57. PG. Marmite tripode LS PG Ma.1.7.c.
Inventaire VB16.1563.22.
- 58. PG. Écuelle/jatte LS PG E.2.3.
Inventaire VB16.1599.37
- 59. PG. Écuelle/jatte LS PG E.2.7.a.
Inventaire VB17.1656.05.
- 60. PG. Écuelle/jatte LS PG E.2.7.b.
Inventaire VB16.1599.34.
- 61. PG. Écuelle/jatte LS PG E.2.7.c.
Inventaire VB16.1563.25.
- 62. PG. Écuelle/jatte LS PG E.2.7.c.
Inventaire VB16.1599.35.



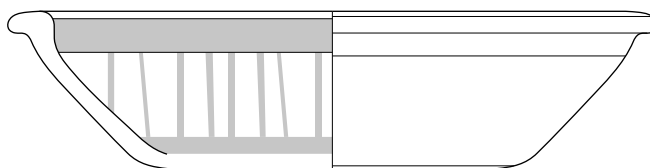
54



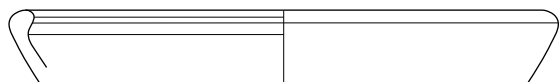
55



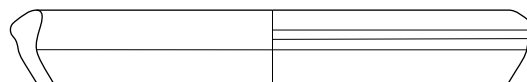
56



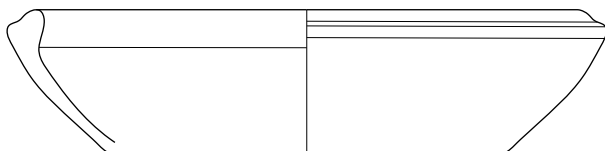
57



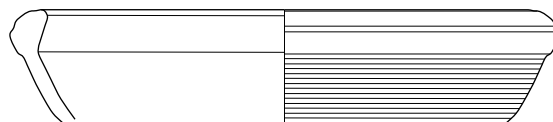
58



59



60



61



62

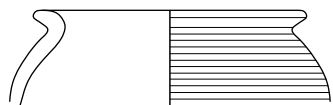
0 5cm

Echelle 1/3
Dessin et numérisation :
M. Sacchetto

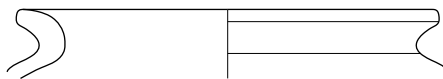
Vidy-Boulodrome, B2, Période D-3, (180 ap. J.-C.), planche 7.7

Communes régionales réduites (suite)

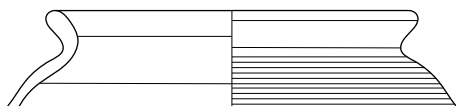
- 63. PG. Pot LS PG P.1.2.a.
Inventaire VB16.1599.36.
- 64. PG. Pot LS PG P.1.3.a.
Inventaire VB17.1808.12.
- 65. PG. Pot LS PG P.1.3.a.
Inventaire VB16.1599.38.
- 66. PG. Pot LS PG P.1.3.b.
Inventaire VB16.1563.28.
- 67. PG. Pot LS PG P.2.3.
Inventaire VB17.1654.04.
- 68. PG. Pot LS PG P.2.3.
Inventaire VB17.1563.23.
- 69. PG. Pot LS PG P.3.1.
Inventaire VB16.1563.29.
- 70. PG. Pot LS PG P.3.3.
Inventaire VB16.1599.39.
- 71. PG. Pot LS PG P.3.7.a.
Inventaire VB16.1599.41.
- 72. PG. Pot LS PG P.3.7.a.
Inventaire VB18.1808.04.
- 73. PG. Couvercle LS PG Cv.1.1.
Inventaire VB17.1808.17.
- 74. PG. Couvercle LS PG Cv.2.1.
Inventaire VB17.1808.16.
- 75. PG. Couvercle LS PG Cv.3.2.a.
Inventaire VB16.1656.29.
- 76. PG. Couvercle LS PG Cv.3.2.a.
Inventaire VB16.1563.30.



63



64



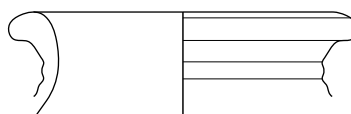
65



66



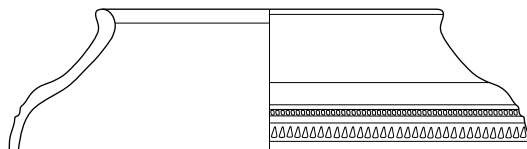
67



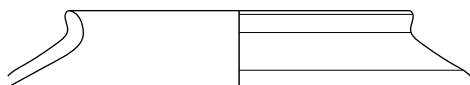
68



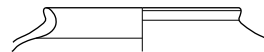
69



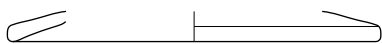
70



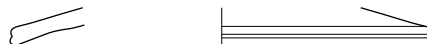
71



72



73



74



75



76

0 5cm

Echelle 1/3

Dessin et numérisation :

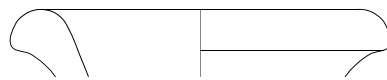
M. Sacchetto

Vidy-Boulodrome, B2, Période D-3, (180 ap. J.-C.), planche 7.8

Amphores à saumure

77. Amphore de type Dressel 9 similis.

Inventaire VB16.1656.18.



77

0 5cm

Echelle 1/3
Dessin et numérisation :
M. Sacchetto
R. Sylvestre (77)

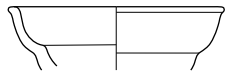
Vidy-Boulodrome, B2, Période C-1, (180 ap. J.-C.), planche 8.1

Fines importées, terres sigillées

1. TSGM. Coupe Drag. 27b.
Inventaire VB18.1113.09.
2. TSGM. Coupe Drag. 33.
Inventaire VB15.1042.07.
3. TSGM. Coupe Drag. 36.
Inventaire VB15.1042.06.
4. TSGC. Coupe Ha. 11.
Inventaire VB17.1042.01.
5. TSGM. Bol à collerette Curle 11.
Inventaire VB15.1113.01.
6. TSGM. Bol Drag. 37.
Estampille : OFGVLVI ?
Inventaire VB17.1042.02

Fines régionales oxydées

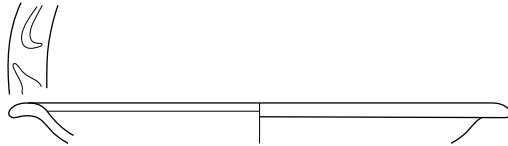
7. CP A. Bol Paunier 11.
Inventaire VB17.1919.07.



1



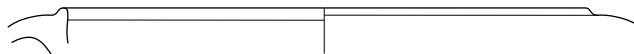
2



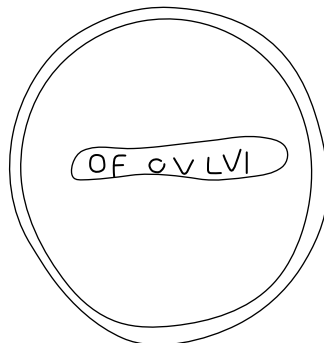
3



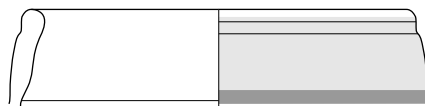
4



5



6 (Estampille à échelle 1:1)



7

0 5cm

Echelle 1/3

Dessin et numérisation :

M. Sacchetto

L. Giardon

A. Giavina

B. Pagni (4)

Vidy-Boulodrome, B2, Période C-1, (180 ap. J.-C.), planche 8.2

Fines régionales, imitations de sigillées

8. TSI. Assiette imit. Drag. 15/17, L7b.

Inventaire VB17.1919.06.

9. TSI. Assiette imit. Ritt. 14b, L14.

Inventaire VB18.1113.10.

10. TSI. Coupe imit. Drag. 35, L33.

Inventaire VB15.1046.03.

11. TSI. Bol imit. Drack 21, L40c.

Inventaire VB15.1042.04.

12. TSI. Bol imit. Drack 21, L40c.

Inventaire VB15.1117.07.

13. TSI. Bol imit. Drack 21, L40c.

Inventaire VB15.1117.08.

14. TSI. Bol imit. Drack 21, L40d.

Inventaire VB15.1042.05.

Fines régionales, céramiques à revêtement argileux

15. RALUIS. Gobelet imit. Mayet 40.

Inventaire VB15.1042.03.

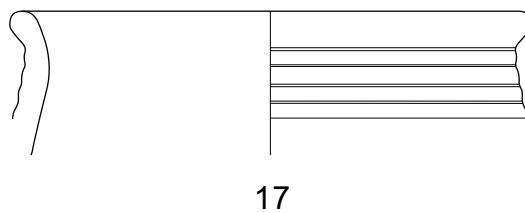
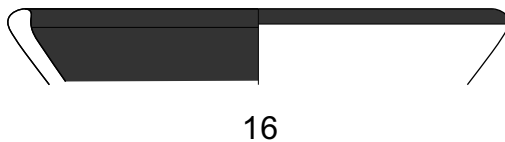
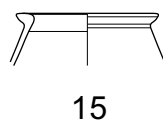
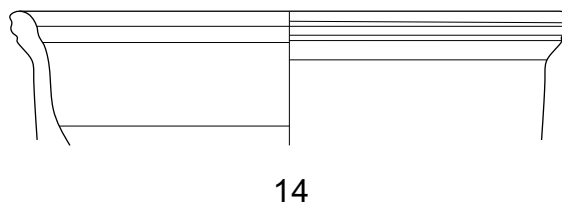
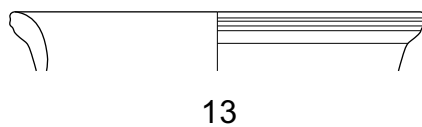
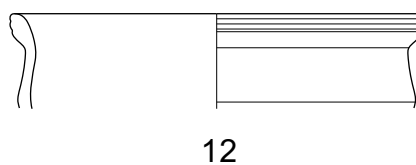
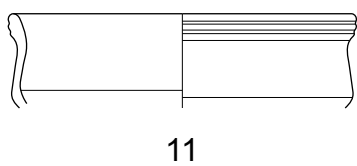
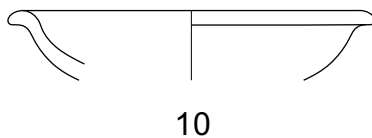
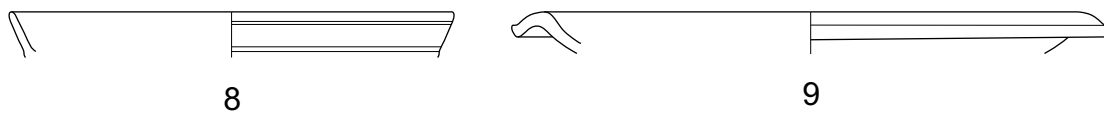
Communes régionales engobées ou lissées

16. EIRN. Plat cf. LS EIR A.2.4.

Inventaire VB15.1117.03.

17. PGTN. Bol AV 139.

Inventaire VB17.1919.13.



0 5cm

Echelle 1/3
Dessin et numérisation :
M. Sacchetto

Vidy-Boulodrome, B2, Période C-1, (180 ap. J.-C.), planche 8.3

Communes régionales engobées ou lissées (suite)

18.PGTN. Gobelet LS PG G.1.1.

Inventaire VB15.1046.01.

19.PGTN. Gobelet hors typologie.

Inventaire VB15.1048.01.

20.PGTN. Pot LS PG P.2.1.

Inventaire VB17.1919.12.

21.PGTN. Pot LS PG P.2.10.

Inventaire VB18.1113.13.

Communes régionales oxydées

22.PCCRU. Cruche LS CRU Cr.2.7.

Inventaire VB18.1113.16.

23.PCCRU. Cruche LS CRU Cr.3.3.

Inventaire VB15.1117.04.

24.PCMOR. Mortier LS MOR Mo.3.6.

Inventaire VB18.1113.07.

25.PC. Écuelle/jatte cf. LS PG E.1.6.

Inventaire VB15.1046.02.

26.PC. Pot LS PC P.1.19.

Inventaire VB18.1113.08.

27.PC. Pot cf. LS PG P.2.10.

Inventaire VB18.1113.17.

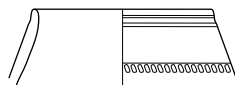
Communes régionales réduites

28.PG. Écuelle/jatte LS PG E.1.1.a.

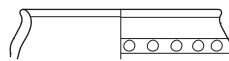
Inventaire VB18.1113.11.

29.PG. Écuelle/jatte LS PG E.1.1.a.

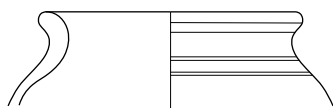
Inventaire VB17.1919.03.



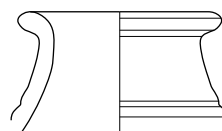
18



19



20



21



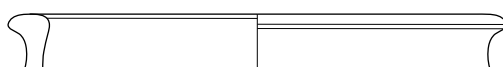
22



23



24



25



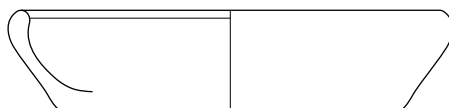
26



27



28



29

0 5cm

Echelle 1/3
Dessin et numérisation :
M. Sacchetto

Vidy-Boulodrome, B2, Période C-1, (180 ap. J.-C.), planche 8.4

Communes régionales réduites (suite)

30.PG. Écuelle/jatte LS PG E.1.6.a.

Inventaire VB17.1919.08.

31.PG. Marmite tripode LS PG Ma.1.7.c.

Inventaire VB17.1919.11.

32.PG. Écuelle/jatte LS PG E.2.1.

Inventaire VB15.1042.09.

33.PG. Écuelle/jatte LS PG E.2.2.

Inventaire VB15.1046.04.

34.PG. Écuelle/jatte LS PG E.2.7.a.

Inventaire VB17.1919.09.

35.PG. Écuelle/jatte LS PG E.2.7.b.

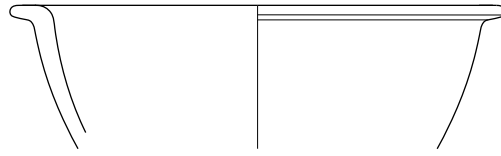
Inventaire VB17.1919.02.

36.PG. Écuelle/jatte LS PG E.2.7.c.

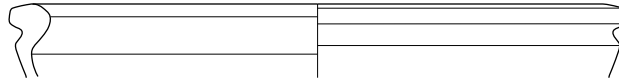
Inventaire VB17.1919.10.

37.PG. Écuelle/jatte LS PG E.2.7.c.

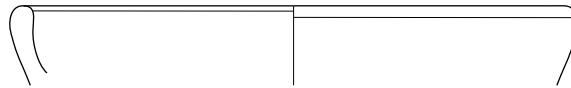
Inventaire VB17.1919.10.



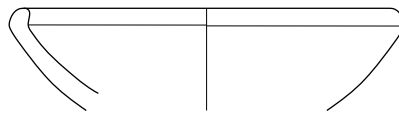
30



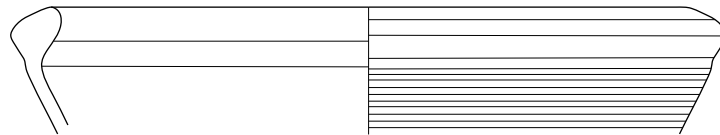
31



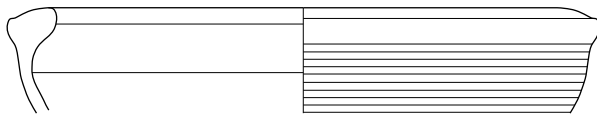
32



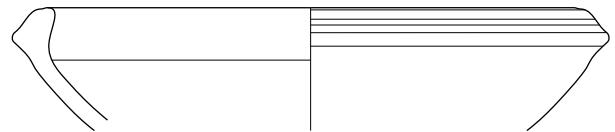
33



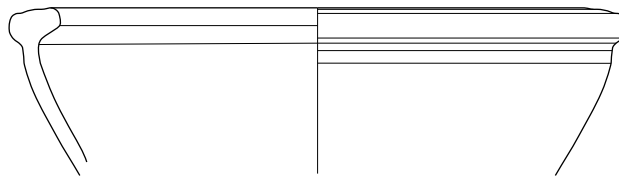
34



35



36



37

0 5cm

Echelle 1/3
Dessin et numérisation :
M. Sacchetto

Vidy-Boulodrome, B2, Période C-1, (180 ap. J.-C.), planche 8.5

Communes régionales réduites (suite)

38.PG. Écuelle/jatte LS PG E.2.7.c.

Inventaire VB18.1113.18.

39.PG. Écuelle/jatte LS PG E.5.2.

Inventaire VB17.1919.04.

40.PG. Bol LS PG B.5.2.

Inventaire VB15.1117.05.

41.PG. Pot LS PG P.1.3.a.

Inventaire VB18.1113.20.

42.PG. Pot LS PG P.1.3.b.

Inventaire VB15.1042.08.

43.PG. Pot LS PG P.1.6.

Inventaire VB15.1117.06.

44.PG. Pot LS PG P.2.2.

Inventaire VB15.1117.09.

45.PG. Pot LS PG P.3.1.

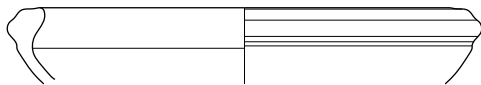
Inventaire VB18.1113.14.

46.PG. Pot LS PG P.3.7.a.

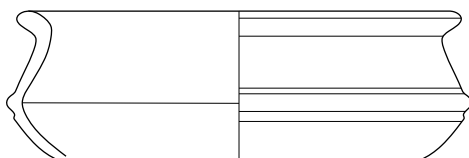
Inventaire VB18.1113.15.

47.PG. Pot LS PG P.3.7.b.

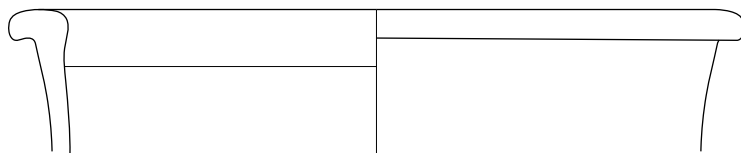
Inventaire VB15.1046.05.



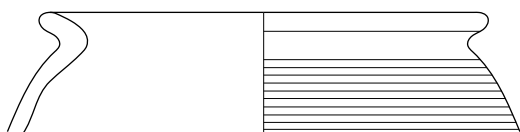
38



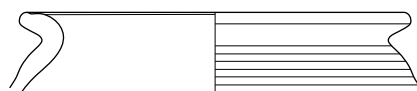
39



40



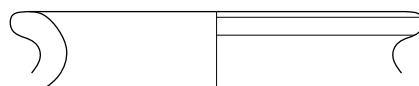
41



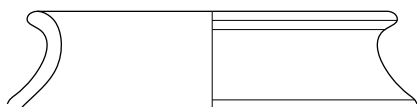
42



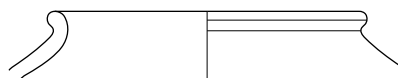
43



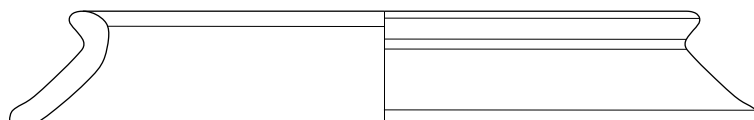
44



45



46



47

0 5cm

Echelle 1/3
Dessin et numérisation :
M. Sacchetto

Vidy-Boulodrome, B2, Période C-1, (180 ap. J.-C.), planche 8.6

Communes régionales réduites (suite)

48.PG. Couvercle LS PG Cv.3.1.

Inventaire VB18.1113.19.

49.PG. Couvercle LS PG Cv.3.2.a.

Inventaire VB17.1919.05.



48



49

0 5cm

Echelle 1/3
Dessin et numérisation :
M. Sacchetto

Vidy-Boulodrome, B2, Période C-1, (180 ap. J.-C.), planche 8.7

Amphores vinaires

50. Amphores de type Gauloise 4.

Inventaire VB19.1113.03.

Amphores à huile

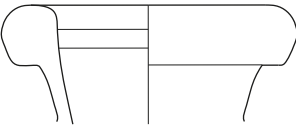
51. Amphore de type Dressel 20.

Inventaire VB15.1117.02.

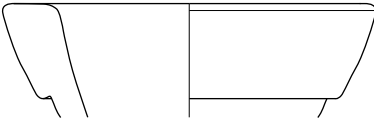
Amphores à saumure

52. Amphore de type Beltran IIA.

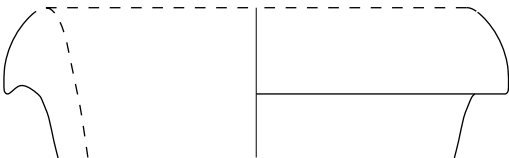
Inventaire VB15.1117.01.



50



51



52

0 5cm

Echelle 1/3

Dessin et numérisation :

M. Sacchetto

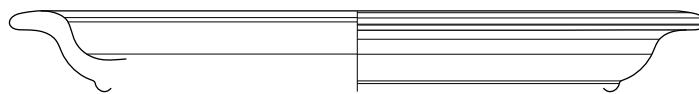
B. Pagni (50)

N. Carron (51-52)

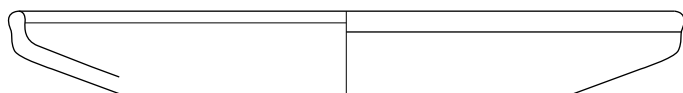
Vidy-Boulodrome, B2, Période C-2, (180/200 ap. J.-C.), planche 9.1

Fines importées, sigillées

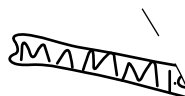
1. TSIT. Plat Consp. 40/42.2.
Inventaire VB15.820.35.
2. TSGC. Assiette Drag. 18/31.
Estampille : MAMMI.O.
Inventaire VB14.707.02.
3. TSG-. Assiette Herm. 29c.
Inventaire VB15.820.102.
4. TSGM. Assiette Drag. 36.
Inventaire VB15.707.42.
5. TSGC. Assiette Drag. 36.
Inventaire VB15.820.43.
6. TSGC. Coupe Drag. 27.
Graffito : A ou V.
Inventaire VB15.820.48.



1

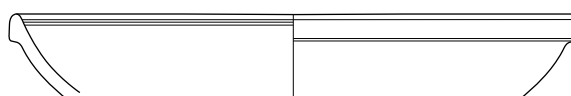


2



2a

(Estampille à échelle 1:1)



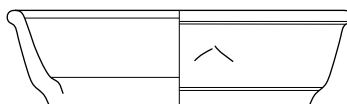
3



4



5



6

0 5cm

Echelle 1/3

Dessin et numérisation :

M. Sacchetto

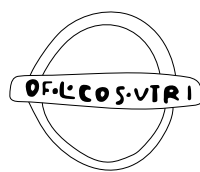
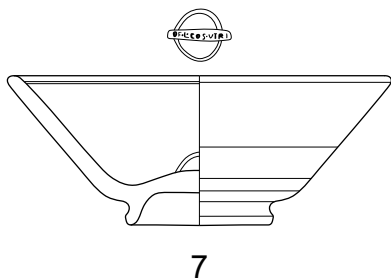
S. Barrier (2)

N. Carron (5)

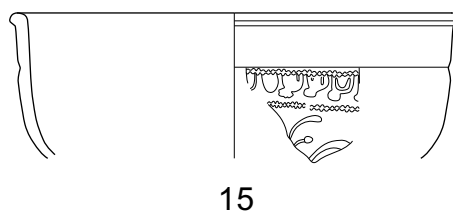
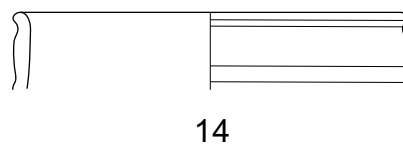
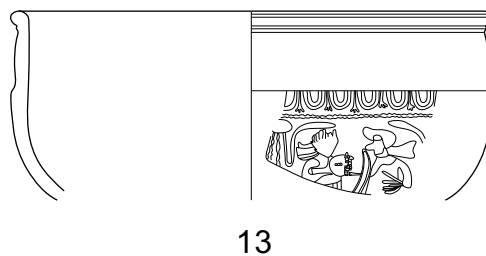
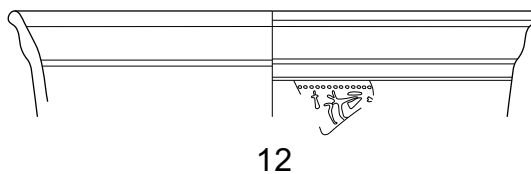
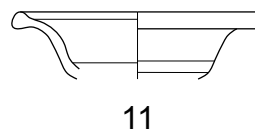
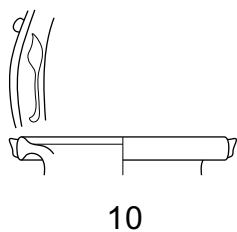
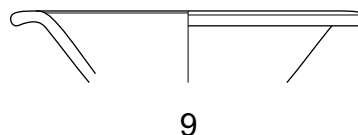
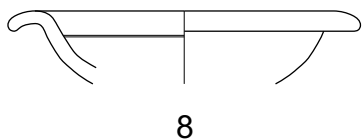
Vidy-Boulodrome, B2, Période C-2, (180/200 ap. J.-C.), planche 9.2

Fines importées, sigillées (suite)

7. TSGM. Coupe Drag. 33.
Estampille : OF.L.COS.VIRI.
Inventaire VB15.820.10.
8. TSGM. Coupe Drag. 35.
Inventaire VB15.820.100.
9. TSG-. Coupe Herm. 28.
Inventaire VB15.820.99.
10. TSGM. Coupe Ritt.14b.
Inventaire VB15.820.79.
11. TSG-. Coupe Curle 15.
Inventaire VB15.820.97.
12. TSG-. Bol Drag. 29b.
Inventaire VB15.820.101.
13. TSGM. Bol Drag. 37.
Inventaire VB15.707.43.
14. TSG-. Bol Drag. 37.
Inventaire VB15.820.72.
15. TSGC. Bol Drag. 37.
Inventaire VB15.820.42.



7a (Estampille à échelle 1:1)



0 5cm

Echelle 1/3
Dessin et numérisation :
M. Sacchetto

Vidy-Boulodrome, B2, Période C-2, (180/200 ap. J.-C.), planche 9.3

Fines importées, sigillées (suite)

16. TSGC. Bol à collerette Curle 11.

Inventaire VB15.820.73.

Fines régionales oxydées

17. CP A. Bol Paunier 11.

Inventaire VB15.707.36.

18. CP A. Bol hors typologie.

Inventaire VB15.820.53.

19. CP A. Pot LS CP P.1.3.

Inventaire VB15.820.11.

20. CP A. Pot LS CP P.1.3.

Inventaire VB15.707.37.

21. CP A. Bouteille Paunier 1.

Inventaire VB15.820.31.

Fines régionales, imitations de sigillées

22. TSI. Bol Drack 20, L39.

Inventaire VB15.820.06.

23. TSI. Bol Drack 20, L39.

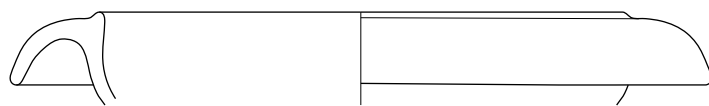
Inventaire VB15.820.80.

24. TSI. Bol Drack 21, L40a.

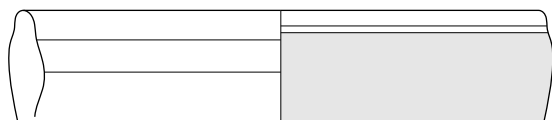
Inventaire VB15.820.76.

25. TSI. Bol Drack 21 L40b.

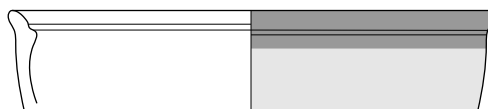
Inventaire VB15.707.39.



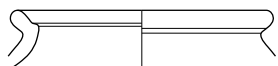
16



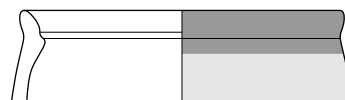
17



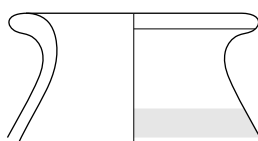
18



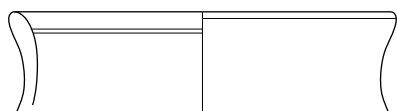
19



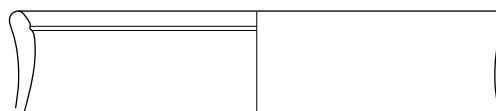
20



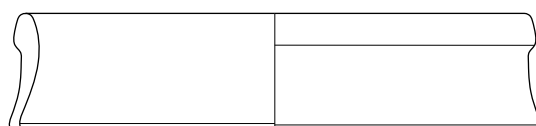
21



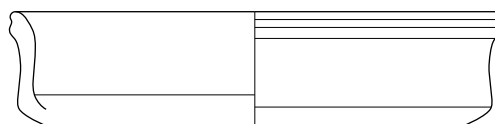
22



23



24



25

0 5cm

Echelle 1/3
Dessin et numérisation :
M. Sacchetto

Vidy-Boulodrome, B2, Période C-2, (180/200 ap. J.-C.), planche 9.4

Fines régionales, imitations de sigillées

- 26. TSI. Bol Drack 21, L40c.
Inventaire VB15.820.75.
- 27. TSI. Bol Drack 21, L40c.
Inventaire VB15.707.34.
- 28. TSI. Bol Drack 21, L40c.
Inventaire VB15.707.40.
- 29. TSI. Bol Drack 21, L40c.
Inventaire VB15.707.41.
- 30. TSI. Bol Drack 21, L40d.
Inventaire VB15.707.35.
- 31. TSI. Bol Drack 21, L40d.
Inventaire VB15.820.70.
- 32. TSI. Bol imit. Drag. 37, L45.
Inventaire VB15.707.47.

Fines régionales, céramiques à revêtement argileux

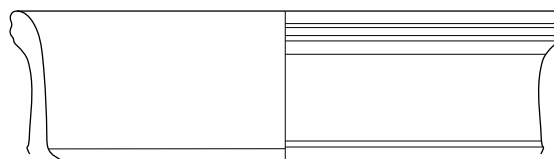
- 33. RALUIS. Gobelet LS RA G.1.5.
Inventaire VB15.820.41.
- 34. RASABL. Gobelet LS RA G.1.7.a.
Inventaire VB15.820.39.
- 35. RALUIS. Gobelet LS RA G.2.1.
Inventaire VB15.820.40.

Communes régionales engobées ou lissées

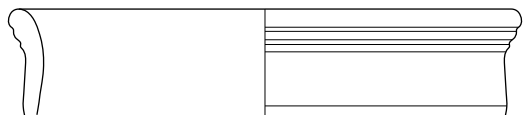
- 36. EIR. Plat LS EIR A.2.4.
Inventaire VB15.820.36.



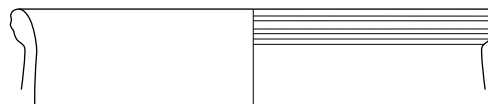
26



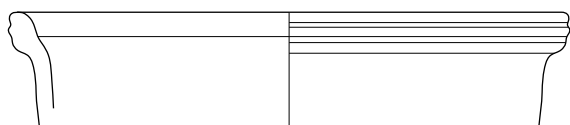
27



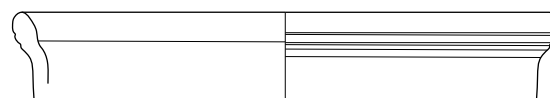
28



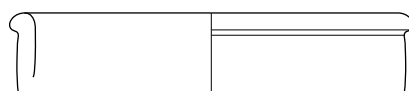
29



30



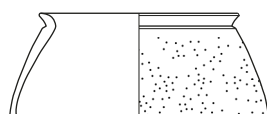
31



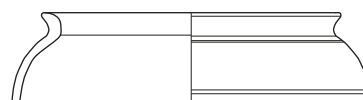
32



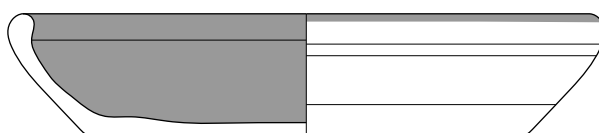
33



34



35



36

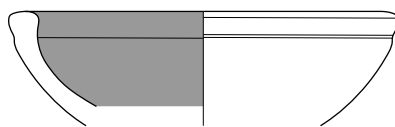
0 5cm

Echelle 1/3
Dessin et numérisation :
M. Sacchetto
N. Carron (33-35)

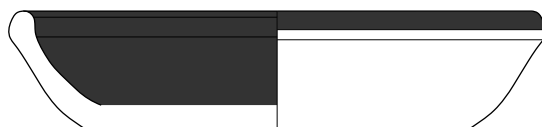
Vidy-Boulodrome, B2, Période C-2, (180/200 ap. J.-C.), planche 9.5

Communes régionales engobées ou lissées (suite)

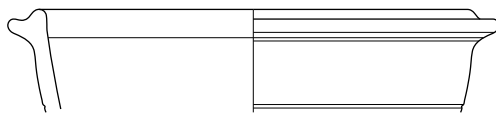
37. EIR. Plat LS EIR A.2.9.
Inventaire VB15.820.74.
38. EIRN. Plat LS EIR A.2.4.
Inventaire VB15.707.44.
39. MICAC. Bol à marli LS MIC B.2.5.
Inventaire VB15.820.62.
40. MICAC. Pot hors typologie.
Inventaire VB15.820.96.
41. MICAC. Tonneau/tonnelet cf. LS PG T.1.3.
Inventaire VB15.707.38.
42. PGTN. Bol AV 139.
Inventaire VB15.820.93.
43. PGTN. Pot LS PG P.2.3.
Inventaire VB15.707.54.
44. PGTN. Pot LS PG P.2.12 var.
Inventaire VB15.820.86.



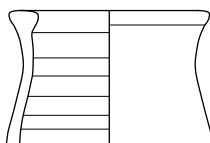
37



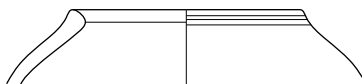
38



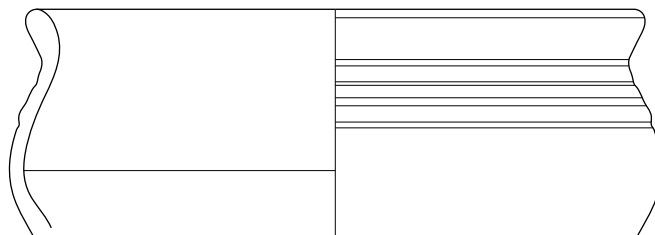
39



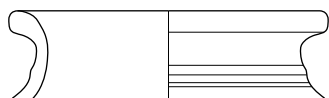
40



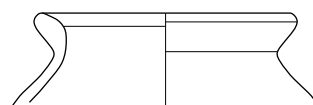
41



42



43



44

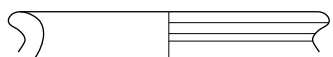
0 5cm

Echelle 1/3
Dessin et numérisation :
M. Sacchetto

Vidy-Boulodrome, B2, Période C-2, (180/200 ap. J.-C.), planche 9.6

Communes régionales engobées ou lissées (suite)

45. PGTN. Pot LS PG P.3.1.
Inventaire VB15.707.55.
46. PGTN. Pot LS PG P.3.7.a.
Inventaire VB15.820.87.
47. PGTN. Pot LS PG P.3.7.b.
Inventaire VB15.820.63.
48. PGTN. Pot LS PG P.3.7.b.
Inventaire VB15.820.77.
49. PGTN. Pot LS PG P.3.7.b.
Inventaire VB15.820.78.
50. PGTN. Pot LS PG P.3.7.b.
Inventaire VB15.820.88.
51. PGTN. Pot LS PG P.3.7.b.
Inventaire VB15.820.89.
52. PGTN. Pot LS PG P.3.7.b.
Inventaire VB15.820.90.
53. PGTN. Pot LS PG P.3.7.b.
Inventaire VB15.820.91.
54. PGTN. Pot LS PG P.3.7.b.
Inventaire VB15.820.92.
55. PGTN. Pot LS PG P.3.7.b.
Graffito: [---] EPPO.
Inventaire VB15.820.51.



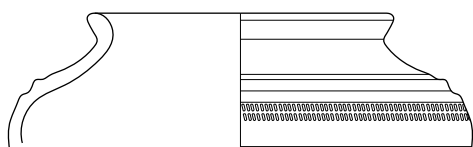
45



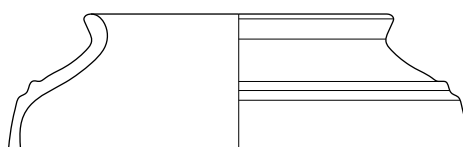
46



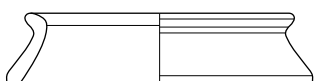
47



48



49



50



51



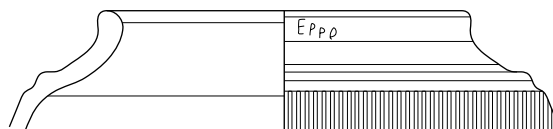
52



53



54



55

0 5cm

Echelle 1/3
Dessin et numérisation :
M. Sacchetto

Vidy-Boulodrome, B2, Période C-2, (180/200 ap. J.-C.), planche 9.7

Communes régionales engobées ou lissées (suite)

56. PGTN. Pot LS PG P.3.7.b.

Graffito: longue sentence, ATTIR-.

Inventaire VB15.820.50.

57. PGTN. Tonneau/tonnelet LS PG T.1.1.b.

Inventaire VB15.820.84.

58. PGTN. Tonneau/tonnelet LS PG T.1.1.c.

Inventaire VB15.820.85.

59. PGTN. Tonneau/tonnelet LS PG T.1.2.

Inventaire VB15.820.82.

60. PGTN. Tonneau/tonnelet AV 16.

Inventaire VB15.820.81.

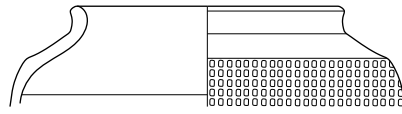
61. PGTN. Tonneau/tonnelet AV 16.

Inventaire VB15.820.83.

Communes régionales oxydées

62. PCCRUCRU. Cruche LS CRU Cr.3.3.b.

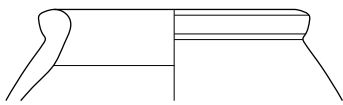
Inventaire VB15.707.45.



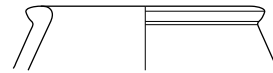
56



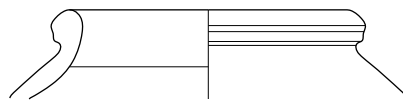
(Graffito à échelle 1:1) 56a



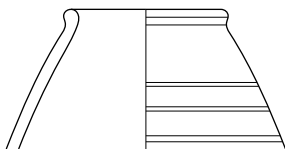
57



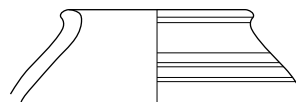
58



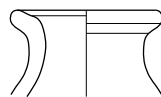
59



60



61



62

0 5cm

Echelle 1/3
Dessin et numérisation :
M. Sacchetto

Vidy-Boulodrome, B2, Période C-2, (180/200 ap. J.-C.), planche 9.8

Communes régionales oxydées (suite)

63. PCCRU. Cruche LS CRU Cr.3.8.

Inventaire VB15.820.37.

64. PCMOR. Mortier LS MOR Mo.3.3.

Inventaire VB15.707.46.

65. PCMOR. Mortier LS MOR Mo.3.6.

Inventaire VB15.820.30.

66. PCMOR. Mortier LS MOR Mo.3.6.

Inventaire VB15.820.103.

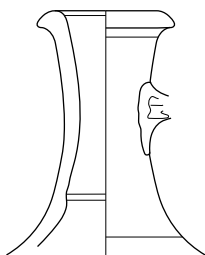
67. PCMOR. Mortier LS MOR Mo.3.6.

Estampille : CVNIN+.

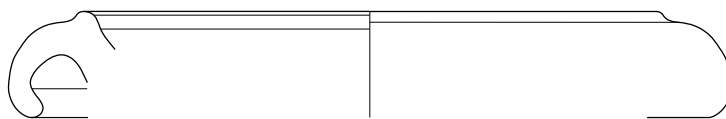
Inventaire VB15.820.29.

68. PC. Écuelle/jatte LS PC E.2.1.

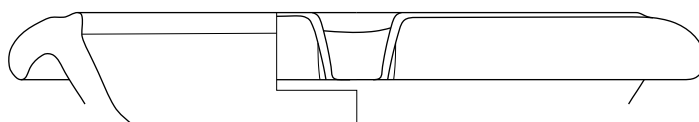
Inventaire VB15.820.95.



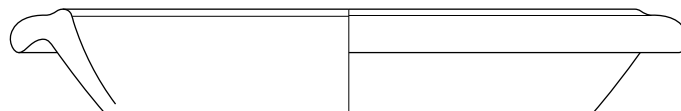
63



64



65



66



67 (Estampille à échelle 1:1)



68

0 5cm

Echelle 1/3

Dessin et numérisation :

M. Sacchetto

A. Giavina (67)

Vidy-Boulodrome, B2, Période C-2, (180/200 ap. J.-C.), planche 9.9

Communes régionales oxydées (suite)

69. PC. Pot LS PC P.1.9.a.

Inventaire VB15.707.48.

70. PC. Couvercle LS PC Cv.2.2.

Inventaire VB15.820.94.

71. PC. Couvercle cf. AV 388.

Inventaire VB15.820.71.

Communes régionales réduites

72. PG. Plat LS PG A.2.2.

Inventaire VB15.707.51.

73. PG. LS PG E.1.1.a.

Inventaire VB15.820.67.

74. PG. Marmite tripode LS PG Ma.1.7.c.

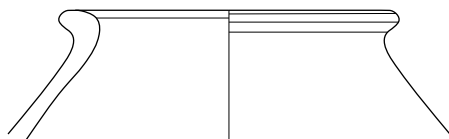
Inventaire VB15.820.68.

75. PG. Écuelle/jatte LS PG E.2.7.c.

Inventaire VB15.707.53.

76. PG. Écuelle/jatte LS PG E.5.2.

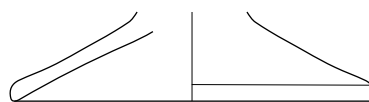
Inventaire VB15.707.49.



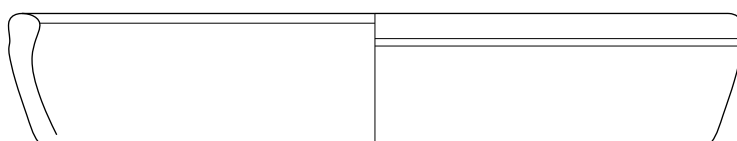
69



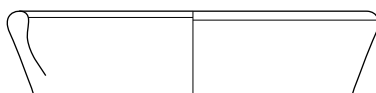
70



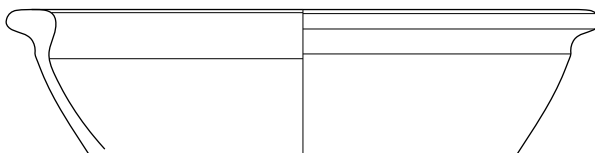
71



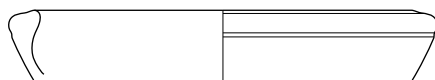
72



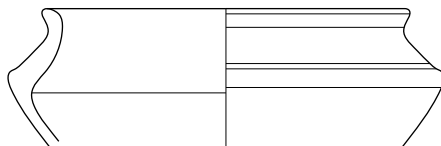
73



74



75



76

0 5cm

Echelle 1/3
Dessin et numérisation :
M. Sacchetto

**Vidy-Boulodrome, B2, Période C-2, (180/200 ap. J.-C.), planche
9.10**

Communes régionales réduites (suite)

77. PG. Pot LS PG P.1.2.a.

Inventaire VB15.707.31.

78. PG. Pot LS PG P.1.2.b.

Inventaire VB15.820.65.

79. PG. Pot LS PG P.1.3.b.

Inventaire VB15.707.33.

80. PG. Pot LS PG P.1.6.

Inventaire VB15.820.69.

81. PG. Pot LS PG P.1.7.

Inventaire VB15.820.66.

82. PG. Pot LS PG P.2.3.

Inventaire VB15.707.52.

83. PG. Pot LS PG P.2.3.

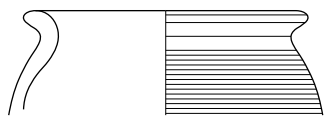
Inventaire VB15.707.32.

84. PG. Pot cf. AV 3/1.

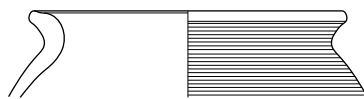
Inventaire VB15.820.104.

85. PG. Dolium LS PG D.1.2.a.

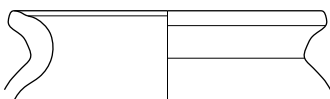
Inventaire VB15.707.50.



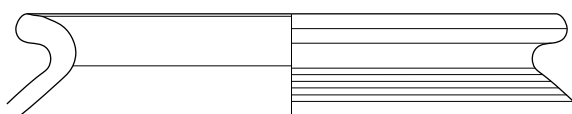
77



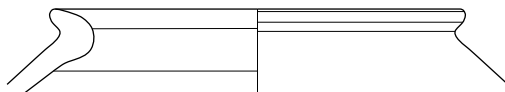
78



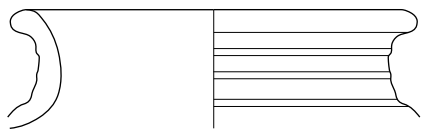
79



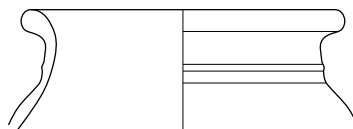
80



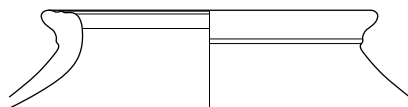
81



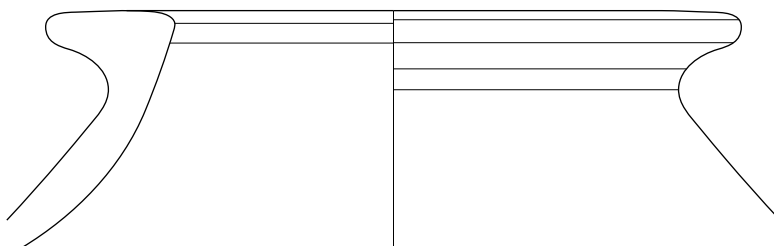
82



83



84



85

0 5cm

Echelle 1/3
Dessin et numérisation :
M. Sacchetto

**Vidy-Boulodrome, B2, Période C-2, (180/200 ap. J.-C.), planche
9.11**

Communes régionales réduites (suite)

86. PG. Dolium LS PG D.1.2.

Inventaire VB15.820.61.

87. PG. Couvercle LS PG Cv.2.1.

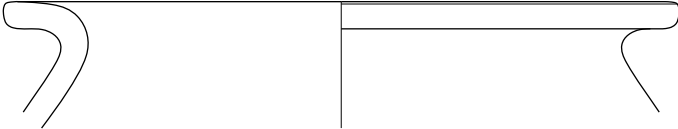
Inventaire VB15.820.98.

88. PG. Couvercle LS PG Cv.3.2.a.

Inventaire VB15.820.64.

89. PG. Couvercle AV 391.

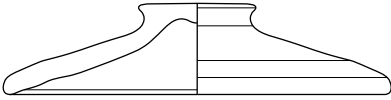
Inventaire VB15.820.09.



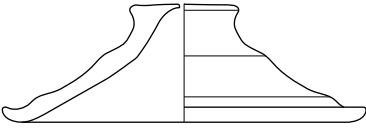
86



87



88



89

0 5cm

Echelle 1/3
Dessin et numérisation :
M. Sacchetto

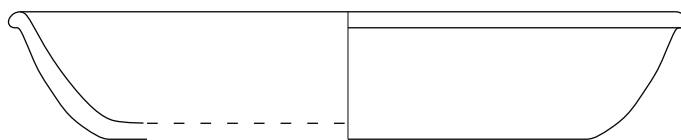
Vidy-Boulodrome, B2, Période C-3, (274 ap. J.-C.), planche 10.1

Fines importées, terres sigillées

1. TSGE. Assiette Drag. 18/31.
Estampille : OC – ISOF.
Inventaire VB14.705.03.
2. TSGE. Assiette Drag. 31.
Inventaire VB14.705.36.
3. TSGC. Assiette Le 032P.
Inventaire VB14.705.25.
4. TSGC. Coupe Drag. 33A.
Inventaire VB14.705.99.
5. TSGM. Coupe Drag. 35.
Inventaire VB14.705.73.
6. TSAF. Coupe Hayes 9a.
Inventaire VB14.705.29.
7. TSGC. Gobelet Déchelette 72.
Inventaire VB15.705.54.
8. TSGC. Bol Drag. 37.
Inventaire VB14.705.67.
9. TSGC. Bol Drag. 37.
Inventaire VB14.705.97.

7021-0

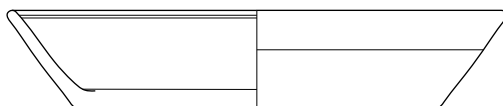
1 (Estampille à échelle 1:1)



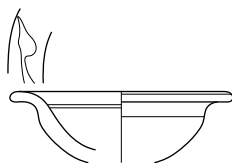
2



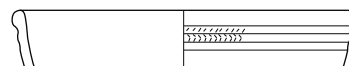
3



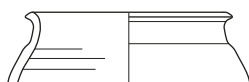
4



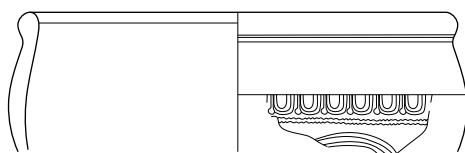
5



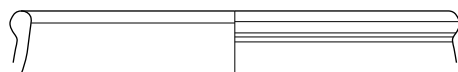
6



7



8



9

0 5cm

Echelle 1/3

Dessin et numérisation :

M. Sacchetto
S. Barrier (2,6)
N. Carron (7)

Vidy-Boulodrome, B2, Période C-3, (274 ap. J.-C.), planche 10.2

Fines importées, terres sigillées (suite)

10. TSGC. Mortier Drag. 45.

Inventaire VB14.705.24.

11. TSGC. Mortier Drag. 45.

Inventaire VB14.705.02.

Fines régionales, importations de sigillées

12. TSI. Coupe imit. Drag. 27, L30.

Inventaire VB15.705.12.

13. TSI. Bol Drack 21, L40c.

Inventaire VB14.705.76.

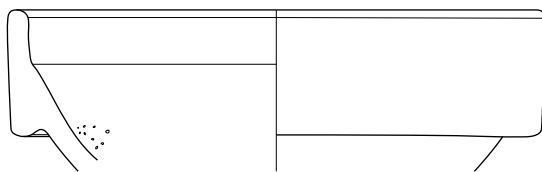
Fines régionales, céramiques à revêtement argileux

14. RALUIS. Assiette imit. Drag. 16.

Inventaire VB14.705.40.

15. RALUIS. Écuelle/jatte LS RA E.2.2.

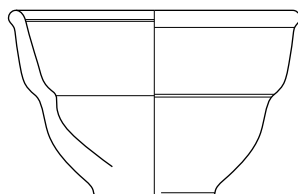
Inventaire VB14.705.27.



10



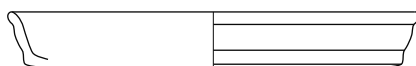
11 (Décor à échelle 1:1)



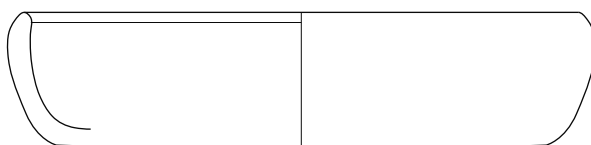
12



13



14



15

0 5cm

Echelle 1/3
Dessin et numérisation :
M. Sacchetto
R. Sylvestre (11)
S. Barrier (14-15)

Vidy-Boulodrome, B2, Période C-3, (274 ap. J.-C.), planche 10.3

Fines régionales, céramiques à revêtement argileux (suite)

16. RAMAT. Écuelle/jatte LS RA E.2.2.

Inventaire VB14.705.87.

17. RAMAT. Écuelle/jatte LS RA E.2.2.

Inventaire VB14.705.104.

18. RALUIS. Bol Lamb. 2/37.

Inventaire VB15.705.55.

19. RANOIR. Bol Lamb. 2/37.

Inventaire VB14.705.35.

20. RAMAT. Bol à marli LS RA B.2.4.

Inventaire VB14.705.70.

21. RAMAT. Gobelet LS RA G.1.4.

Inventaire VB14.705.92.

22. RALUIS. Gobelet LS RA G.1.4.

Inventaire VB14.705.10.

23. RAMET. Gobelet LS RA G.1.4.

Inventaire VB14.705.01.

24. RAMET. Gobelet LS RA G.1.4.

Inventaire VB14.705.28.

25. RALUIS. Gobelet LS RA G.1.5.

Inventaire VB14.705.95.

26. RALUIS. Gobelet LS RA G.1.7.a.

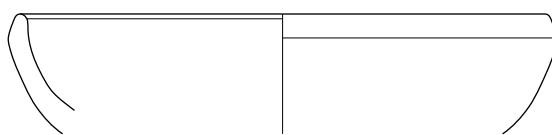
Inventaire VB14.705.71.

27. RALUIS. Gobelet LS RA G.1.7.a.

Inventaire VB15.705.50.

28. RALUIS. Gobelet LS RA G.1.7.a.

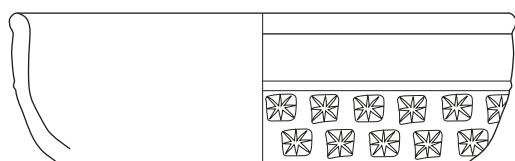
Inventaire VB15.705.51.



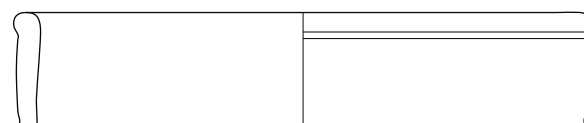
16



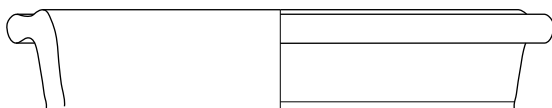
17



18



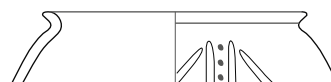
19



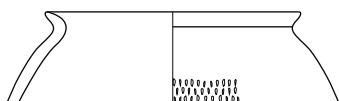
20



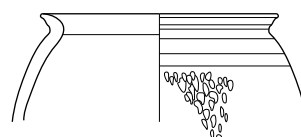
21



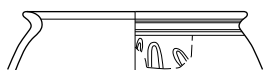
22



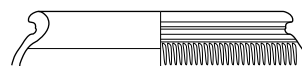
23



24



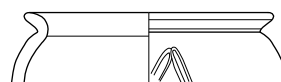
25



26



27



28

0 5cm

Echelle 1/3

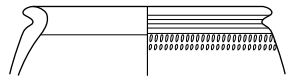
Dessin et numérisation :

M. Sacchetto
N. Carron (18, 27)
S. Barrier (22-23)

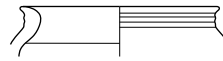
Vidy-Boulodrome, B2, Période C-3, (274 ap. J.-C.), planche 10.4

Fines régionales, céramiques à revêtement argileux (suite)

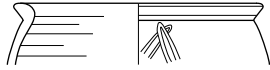
- | | |
|---|--|
| 29. RALUIS. Gobelet LS RA
G.1.7 Inventaire
VB14.705.96. | 39. RALUIS. Gobelet LS RA
G.2.3.b.
Inventaire VB14.705.78. |
| 30. RALUIS. Gobelet LS RA
G.1.7.a.
Inventaire VB14.705.93. | 40. RAMET. Gobelet LS RA
G.2.3.b.
Inventaire VB15.705.47. |
| 31. RAMET. Gobelet LS RA
G.1.7.a. Inventaire
VB15.705.46. | 41. RALUIS. Gobelet LS RA
G.2.4.
Inventaire VB14.705.34. |
| 32. RAMET. Gobelet LS RA
G.1.7.a.
Inventaire VB15.705.45. | 42. RALUIS. Gobelet LS RA
G.3.2.
Inventaire VB14.705.72. |
| 33. RALUIS. Gobelet LS RA
G.1.7.a.
Inventaire VB15.705.53. | 43. RALUIS. Gobelet AV 10/2.
Inventaire VB14.705.11. |
| 34. RAMET. Gobelet LS RA
G.2.1 var.
Inventaire VB15.705.48. | 44. RALUIS. Gobelet AV 49.
Inventaire VB15.705.52. |
| 35. RALUIS. Gobelet LS RA
G.2.3.a.
Inventaire VB14.705.84. | 45. RALUIS. Gobelet Nied. 32.
Inventaire VB14.705.100. |
| 36. RAMET. Gobelet LS RA
G.2.3.a.
Inventaire VB15.705.49. | 46. RALUIS. Cruche cf. AV 345.
Inventaire VB15.705.15. |
| 37. RALUIS. Gobelet LS RA
G.2.3.b.
Inventaire VB14.705.85. | |
| 38. RALUIS. Gobelet LS RA
G.2.3.b.
Inventaire VB14.705.69. | |



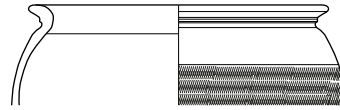
30



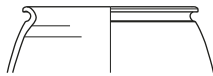
29



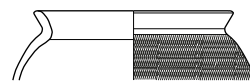
31



32



33



34



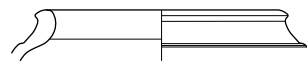
35



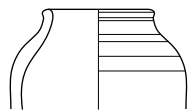
36



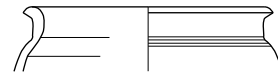
37



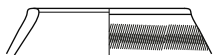
38



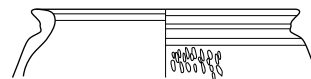
39



40



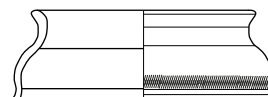
41



42



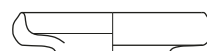
43



44



45



46

0 5cm

Echelle 1/3

Dessin et numérisation :

M. Sacchetto
N. Carron (31-34,
36, 40, 44, 46)
S. Barrier (41, 43)

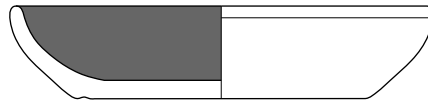
Vidy-Boulodrome, B2, Période C-3, (274 ap. J.-C.), planche 10.5

Communes régionales engobées ou lissées

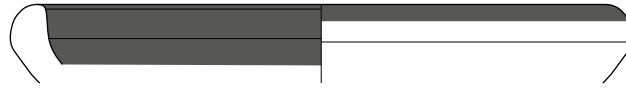
- 47. EIR. Plat LS EIR A.2.1.c.
Inventaire VB14.705.101.
- 48. EIRN. Plat LS EIR A.2.1.
Inventaire VB14.705.90.
- 49. MICAC. Écuelle/jatte LS MIC E.1.1.
Inventaire VB14.705.22.
- 50. MICAC. Écuelle/jatte LS MIC E.2.1.
Inventaire VB14.705.105.
- 51. MICAC. Écuelle/jatte LS MIC E.2.1.
Inventaire VB14.705.88.
- 52. MICAC. Pot LS MIC P.1.1.
Inventaire VB14.705.91
- 53. MICAC. Pot AV 42.
Inventaire VB14.705.102.
- 54. PGTN. Assiette imit. Curle 15.
Inventaire VB14.705.31.
- 55. PGTN. Bol AV 136.
Inventaire VB14.705.37.
- 56. PGTN. Tonneau/tonnelet cf. AV 26/2.
Inventaire VB14.705.83.

Communes régionales oxydées

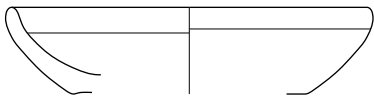
- 57. PCCRU. Cruche LS CRU Cr.1.2.a.
Inventaire VB14.705.82.



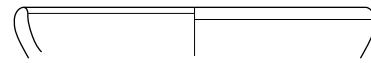
47



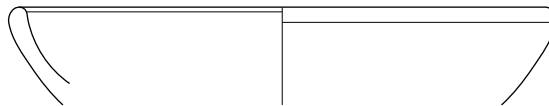
48



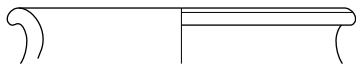
49



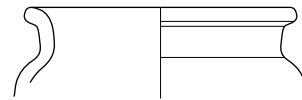
50



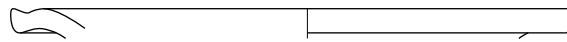
51



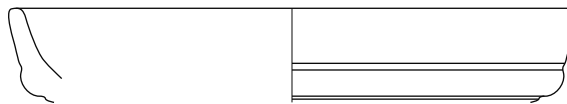
52



53



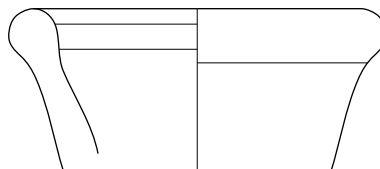
54



55



56



57

0 5cm

Echelle 1/3

Dessin et numérisation :

M. Sacchetto
S. Barrier (54-55)

Vidy-Boulodrome, B2, Période C-3, (274 ap. J.-C.), planche 10.6

Communes régionales oxydées (suite)

58. PCMOR. Mortier LS MOR Mo.3.6.

Inventaire VB14.705.86.

59. PC. Écuelle/jatte LS PC E.2.2.

Inventaire VB14.705.81.

60. PC. Pot LS PC P.1.6.

Inventaire VB14.705.79.

61. PC. Pot cf. LS PG P.1.7.

Inventaire VB14.705.77.

62. PC. Pot LS PC P.2.2.

Inventaire VB14.705.80.

63. PC. Couvercle cf. LS PC Cv.2.2.

Inventaire VB14.705.23.

64. PC. Couvercle AV 389.

Inventaire VB14.705.98.

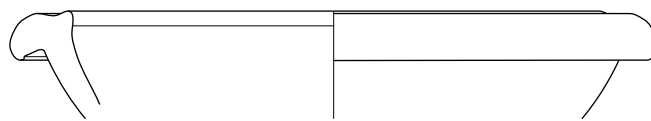
Communes régionales réduites

65. PG. Marmite tripode LS PG Ma.1.7.c.

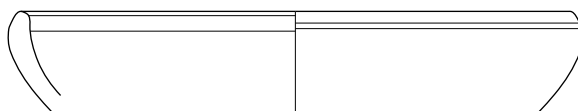
Inventaire VB14.705.74.

66. PG. Écuelle/jatte LS PG E.2.2.

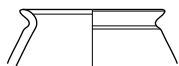
Inventaire VB14.705.94.



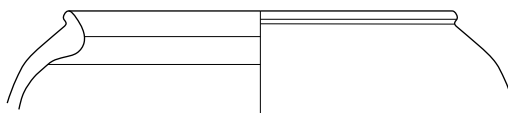
58



59



60



61



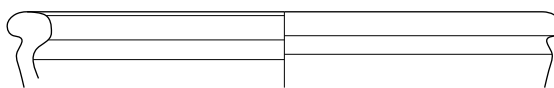
62



63



64



65



66

0 5cm

Echelle 1/3

Dessin et numérisation :

M. Sacchetto

Vidy-Boulodrome, B2, Période C-3, (274 ap. J.-C.), planche 10.7

Communes régionales réduites (suite)

67. PG. Pot LS PG P.1.3.b.

Inventaire VB14.705.75.

68. PG. Pot LS PG P.2.2.

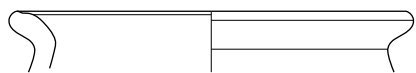
Inventaire VB14.705.89.

69. PG. Pot LS PG P.2.3.

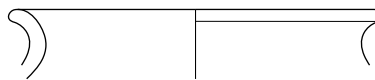
Inventaire VB14.705.68.

70. PG. Pot LS PG P.2.6.

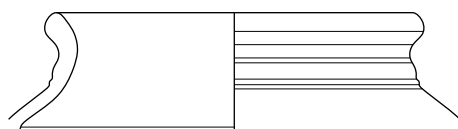
Inventaire VB14.705.103.



67



68



69



70

0 5cm

Echelle 1/3
Dessin et numérisation :
M. Sacchetto

Vidy-Boulodrome, B2, Période B, (330 ap. J.-C.), planche 11.1

Fines importées, terres sigillées

1. TSGM. Bol Drag. 37.
Inventaire VB14.555.47.
2. TSGC. Bol Drag. 37.
Inventaire VB14.555.48.

Fines régionales, imitations de terres sigillées

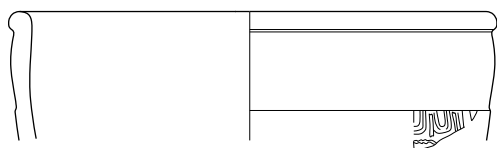
3. TSI. Assiette imit. Drag. 15/17, L7.
Inventaire VB14.555.71.

Fines régionales, céramiques à revêtement argileux

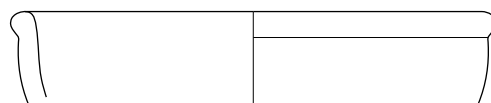
4. RALUIS. Gobelet LS RA G.1.5.
Inventaire VB14.555.61.
5. RALUIS. Gobelet LS RA G.1.7.a.
Inventaire VB14.555.67.
6. RALUIS. Gobelet LS RA G.2.1.
Inventaire VB14.555.64.
7. RALUIS. Gobelet LS RA G.2.1.
Inventaire VB14.555.68.
8. RAMET. Gobelet LS RA G.2.2.
Inventaire VB14.555.46.
9. RAMAT. Gobelet AV 100.
Inventaire VB14.555.66.
10. RANOIR. Gobelet Nied. 32-33.
Inventaire VB14.555.45.
11. RANOIR. Gobelet Nied. 33.
Inventaire VB14.555.44.

Communes régionales engobées ou lissées

12. MICAC. Écuille/jatte LS MIC E.1.1.
Inventaire VB14.555.54.
13. MICAC. Bol à marli LS MIC B.2.5.
Inventaire VB14.555.52



1



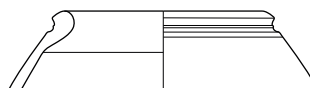
2



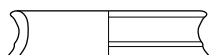
3



4



5



6



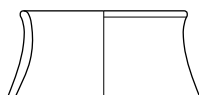
7



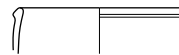
8



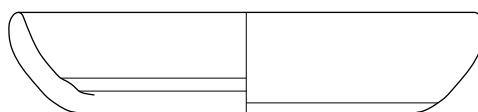
9



10



11



12



13

0 5cm

Echelle 1/3
Dessin et numérisation :
M. Sacchetto

Vidy-Boulodrome, B2, Période B, (330 ap. J.-C.), planche 11.2

Communes régionales engobées ou lissées (suite)

14. PGTN. Pot LS PG P.2.2.

Inventaire VB14.555.63.

Communes régionales oxydées

15. PCMOR. Mortier LS MOR Mo.3.2.b.

Inventaire VB14.555.60.

16. PCMOR. Mortier LS MOR Mo.3.3.

Inventaire VB14.555.72.

17. PC. Écuelle/jatte LS PC E.2.1.

Inventaire VB14.555.49.

18. PC. Écuelle/jatte LS PC E.2.2.

Inventaire VB14.555.56.

19. PC. Écuelle/jatte LS PC E.2.3.

Inventaire VB14.555.57.

20. PC. Écuelle/jatte cf. LS PG E.2.7.b.

Inventaire VB14.555.58.

21. PC. Écuelle/jatte cf. LS PG E.2.7.

Inventaire VB14.555.65.

22. PC. Écuelle/jatte AV 283.

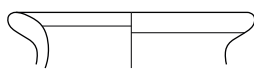
Inventaire VB14.555.53.

23. PC. Écuelle/jatte hors typologie.

Inventaire VB14.555.55.

24. PC. Bol à collerette cf. AV 218/1.

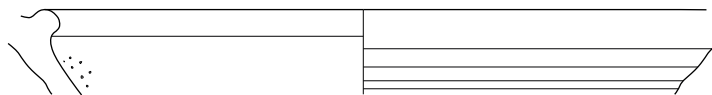
Inventaire VB14.555.59.



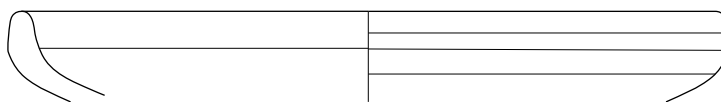
14



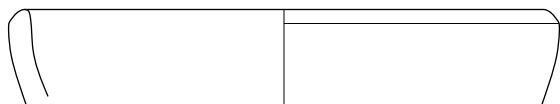
15



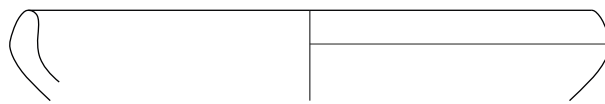
16



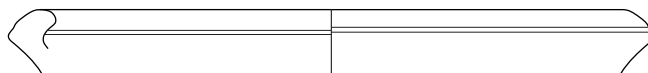
17



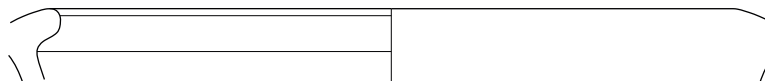
18



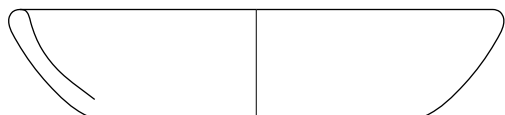
19



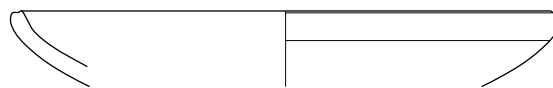
20



21



22



23



24

0 5cm

Echelle 1/3
Dessin et numérisation :
M. Sacchetto

Vidy-Boulodrome, B2, Période B, (330 ap. J.-C.), planche 11.3

Communes régionales réduites

25. PG. Écuelle/jatte AV 225/2.

Inventaire VB14.555.62.

26. PGGROS. Écuelle/jatte AV 284/2.

Inventaire VB14.555.08.

27. PG. Bol cf. AV 160/1.

Inventaire VB14.555.50.

28. PG. Pot LS PG P.2.7.

Inventaire VB14.555.69.

29. PG. Pot LS PG P.2.10.

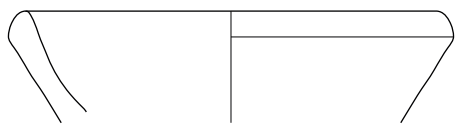
Inventaire VB14.555.43.

30. PG. Pot LS PG P.3.7.b.

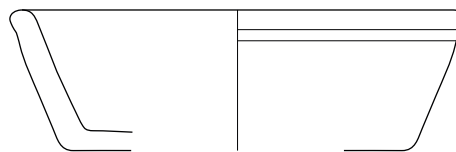
Inventaire VB14.555.70.

31. PG. Pot AV 47.

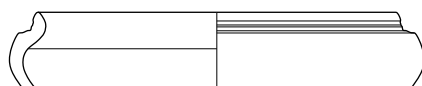
Inventaire VB14.555.51.



25



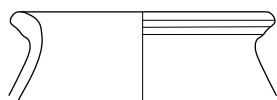
26



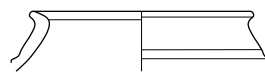
27



28



29



30



31

0 5cm

Echelle 1/3

Dessin et numérisation :

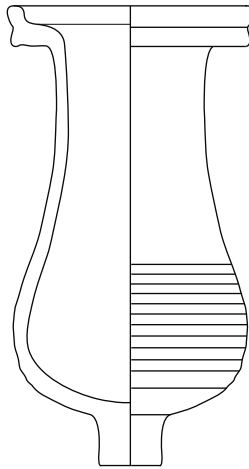
M. Sacchetto

Vidy-Boulodrome, B2, Période B, (330 ap. J.-C.), planche 11.4

Amphoriques

32. Amphore. Amphorique.

Inventaire VB14.555.14.



32

0 5cm

Echelle 1/3
Dessin et numérisation :
M. Sacchetto
S. Barrier (32)

Références des figures¹

Fig.2.1: Swisstopo.

Fig. 2.2: Plan et DAO par José Bernal (IASA).

Fig. 3.1: *Idem*.

Fig. 3.2: *Idem*.

Fig. 3.3: LANTHEMANN et LUGINBÜHL (dir.), 2018, pp.121.

Fig. 3.4: *Ibidem*, p. 122.

Fig. 3.5: *Ibidem*, p. 123.

Fig. 3.6: *Ibidem*, p. 124.

Fig. 3.7: *Ibidem*, p. 126.

Fig. 3.8.: *Ibidem*, p. 127.

Fig. 4.1: LANTHEMANN et LUGINBÜHL (dir.), 2020, p. 105.

Fig. 4.2: *Ibidem*, p. 113.

Fig. 4.3: *Ibidem*, p. 118.

Fig. 4.4: *Ibidem*, p. 125.

Fig. 4.5: *Ibidem*, p. 135.

Fig. 4.6: *Ibidem*, p. 138.

Fig. 4.7: LANTHEMANN et LUGINBÜHL (dir.), 2019, p. 185.

Fig. 4.8: *Ibidem*, p. 187.

Fig. 4.9: *Ibidem*, p. 188.

Fig. 4.10: *Ibidem*, p. 189.

Fig. 6.1: LANTHEMANN et LUGINBÜHL (dir.), 2020, p. 114.

Fig. 6.2: Diagramme par Fanny Lanthemann (IASA).

Fig. 8.1: LANTHEMANN et LUGINBÜHL (dir.), 2020, p. 118.

Fig. 8.2: *Ibidem*, p. 189.

Fig. 72: Tableau d'après F. Lanthemann, A. Rochat et L. Rubeli. Conférence intitulée «Identifier la fonction des espaces au sein de l'habitat modeste : une confrontation des indices archéologiques sur le site de Vidy-Boulodrome. », tenue le 15.11.2019 à Lyon.

¹ Toutes les figures qui ne sont pas mentionnées dans cette liste ont été réalisées par l'auteur de ce travail.

